

# User Manual

**Tektronix**

**TDS3000 Series**  
**Digital Phosphor Oscilloscopes**  
**071-0274-01**

This document supports firmware version 2.00  
and above.



Copyright © Tektronix, Inc. All rights reserved.

Tektronix products are covered by U.S. and foreign patents, issued and pending. Information in this publication supercedes that in all previously published material. Specifications and price change privileges reserved.

Printed in the U.S.A.

Tektronix, Inc., P.O. Box 1000, Wilsonville, OR 97070–1000

TEKTRONIX, TEK, TEKPROBE, and Tek Secure are registered trademarks of Tektronix, Inc.

DPX is a trademark of Tektronix, Inc.

## OSCILLOSCOPE WARRANTY

Tektronix warrants that the products that it manufactures and sells will be free from defects in materials and workmanship for a period of three (3) years from the date of purchase from an authorized Tektronix distributor. If any such product proves defective during this warranty period, Tektronix, at its option, either will repair the defective product without charge for parts and labor, or will provide a replacement in exchange for the defective product. Batteries are excluded from this warranty.

In order to obtain service under this warranty, Customer must notify Tektronix of the defect before the expiration of the warranty period and make suitable arrangements for the performance of service. Customer shall be responsible for packaging and shipping the defective product to the service center designated by Tektronix, shipping charges prepaid, and with a copy of customer proof of purchase. Tektronix shall pay for the return of the product to Customer if the shipment is to a location within the country in which the Tektronix service center is located. Customer shall be responsible for paying all shipping charges, duties, taxes, and any other charges for products returned to any other locations.

This warranty shall not apply to any defect, failure or damage caused by improper use or improper or inadequate maintenance and care. Tektronix shall not be obligated to furnish service under this warranty a) to repair damage resulting from attempts by personnel other than Tektronix representatives to install, repair or service the product; b) to repair damage resulting from improper use or connection to incompatible equipment; c) to repair any damage or malfunction caused by the use of non-Tektronix supplies; or d) to service a product that has been modified or integrated with other products when the effect of such modification or integration increases the time or difficulty of servicing the product.

**THIS WARRANTY IS GIVEN BY TEKTRONIX WITH RESPECT TO THE LISTED PRODUCTS IN LIEU OF ANY OTHER WARRANTIES, EXPRESS OR IMPLIED. TEKTRONIX AND ITS VENDORS DISCLAIM ANY IMPLIED WARRANTIES OF MERCHANTABILITY OR FITNESS FOR A PARTICULAR PURPOSE. TEKTRONIX' RESPONSIBILITY TO REPAIR OR REPLACE DEFECTIVE PRODUCTS IS THE SOLE AND EXCLUSIVE REMEDY PROVIDED TO THE CUSTOMER FOR BREACH OF THIS WARRANTY. TEKTRONIX AND ITS VENDORS WILL NOT BE LIABLE FOR ANY INDIRECT, SPECIAL, INCIDENTAL, OR CONSEQUENTIAL DAMAGES IRRESPECTIVE OF WHETHER TEKTRONIX OR THE VENDOR HAS ADVANCE NOTICE OF THE POSSIBILITY OF SUCH DAMAGES.**

## PROBE WARRANTY

Tektronix warrants that the products that it manufactures and sells will be free from defects in materials and workmanship for a period of one (1) year from the date of purchase from an authorized Tektronix distributor. If any such product proves defective during this warranty period, Tektronix, at its option, either will repair the defective product without charge for parts and labor, or will provide a replacement in exchange for the defective product. Batteries are excluded from this warranty.

In order to obtain service under this warranty, Customer must notify Tektronix of the defect before the expiration of the warranty period and make suitable arrangements for the performance of service. Customer shall be responsible for packaging and shipping the defective product to the service center designated by Tektronix, shipping charges prepaid, and with a copy of customer proof of purchase. Tektronix shall pay for the return of the product to Customer if the shipment is to a location within the country in which the Tektronix service center is located. Customer shall be responsible for paying all shipping charges, duties, taxes, and any other charges for products returned to any other locations.

This warranty shall not apply to any defect, failure or damage caused by improper use or improper or inadequate maintenance and care. Tektronix shall not be obligated to furnish service under this warranty a) to repair damage resulting from attempts by personnel other than Tektronix representatives to install, repair or service the product; b) to repair damage resulting from improper use or connection to incompatible equipment; c) to repair any damage or malfunction caused by the use of non-Tektronix supplies; or d) to service a product that has been modified or integrated with other products when the effect of such modification or integration increases the time or difficulty of servicing the product.

**THIS WARRANTY IS GIVEN BY TEKTRONIX WITH RESPECT TO THE LISTED PRODUCTS IN LIEU OF ANY OTHER WARRANTIES, EXPRESS OR IMPLIED. TEKTRONIX AND ITS VENDORS DISCLAIM ANY IMPLIED WARRANTIES OF MERCHANTABILITY OR FITNESS FOR A PARTICULAR PURPOSE. TEKTRONIX' RESPONSIBILITY TO REPAIR OR REPLACE DEFECTIVE PRODUCTS IS THE SOLE AND EXCLUSIVE REMEDY PROVIDED TO THE CUSTOMER FOR BREACH OF THIS WARRANTY. TEKTRONIX AND ITS VENDORS WILL NOT BE LIABLE FOR ANY INDIRECT, SPECIAL, INCIDENTAL, OR CONSEQUENTIAL DAMAGES IRRESPECTIVE OF WHETHER TEKTRONIX OR THE VENDOR HAS ADVANCE NOTICE OF THE POSSIBILITY OF SUCH DAMAGES.**

# Table of Contents

<b>General Safety Summary</b> .....	<b>iv</b>
<b>Preface</b> .....	<b>viii</b>
Contacting Tektronix .....	ix

## Getting Started

Initial Setup .....	1-1
Functional Check .....	1-2
Probe Compensation .....	1-3
Signal Path Compensation (SPC) .....	1-4
Product and Feature Description .....	1-4
Acquisition Features .....	1-5
Signal Processing Features .....	1-5
Display Features .....	1-6
Measurement Features .....	1-6
Trigger Features .....	1-6
Convenience Features .....	1-7
Optional Features .....	1-7
Transporting the Oscilloscope .....	1-8
Operating Positions .....	1-9
Connecting Power .....	1-9
Using Battery Power .....	1-10
Operating Safely with Battery Power .....	1-11
Installing the Battery .....	1-12
Maximizing Operating Time .....	1-13
Charging the Battery .....	1-14
Installing an Application Module .....	1-15
Installing a Communication Module .....	1-17
Front-Panel Menus and Controls .....	1-18
Using the Menu System .....	1-18
Using the Menu Buttons .....	1-21
Using the Dedicated Controls .....	1-23
Identifying Items in the Display .....	1-26
Using QuickMenus .....	1-28
Front-Panel Connectors .....	1-30
Rear-Panel Connectors .....	1-31

## Application Examples

Taking Simple Measurements .....	2-2
Using Autoset .....	2-2
Selecting Automatic Measurements .....	2-3
Measuring Two Signals .....	2-4
Customizing Your Measurements .....	2-6
Analyzing Signal Detail .....	2-9
Looking at a Noisy Signal .....	2-10
Separating the Signal from Noise .....	2-11
Taking Cursor Measurements .....	2-12
Using Delay .....	2-13
Measuring Jitter .....	2-15
Triggering on a Video Signal .....	2-16
Capturing a Single-Shot Signal .....	2-20
Optimizing the Acquisition .....	2-21
Using the Horizontal Zoom Function .....	2-22
Using the Disk Drive .....	2-23
Saving Screen Images .....	2-24
Saving Waveform Data .....	2-27

## Reference

<b>Introduction to Reference .....</b>	<b>3-1</b>
Acquisition Controls .....	3-2
Cursor .....	3-12
Display .....	3-17
Hard Copy .....	3-21
Horizontal Controls .....	3-25
Measure .....	3-33
QuickMenu .....	3-39
Save/Recall .....	3-40
Trigger Controls .....	3-49
Utility .....	3-60
Vertical Controls .....	3-70

## Appendices

<b>Appendix A: Specifications</b> .....	<b>A-1</b>
<b>Appendix B: Factory Setup</b> .....	<b>B-1</b>
<b>Appendix C: Accessories</b> .....	<b>C-1</b>
<b>Appendix D: Probe Basics</b> .....	<b>D-1</b>
Probe Descriptions .....	D-1
Probe Compensation .....	D-2
TekProbe Interface .....	D-2
Probe Guard .....	D-3
Ground Leads .....	D-3
P3010 High-Frequency Compensation .....	D-4
P3010 Replaceable Parts and Accessories .....	D-6
P6139A Replaceable Parts and Accessories .....	D-8
Using Other Probes .....	D-10
Supported Active Probes .....	D-11
Unsupported Probes .....	D-12
<b>Appendix E: Performance Verification</b> .....	<b>E-1</b>
Test Record .....	E-2
Performance Verification Procedures .....	E-5
<b>Appendix F: General Care and Cleaning</b> .....	<b>F-1</b>
General Care .....	F-1
Cleaning .....	F-1

## Glossary

## Index



# General Safety Summary

Review the following safety precautions to avoid injury and prevent damage to this product or any products connected to it. To avoid potential hazards, use this product only as specified.

## To Avoid Fire or Personal Injury

**Use Proper Power Cord.** Use only the power cord specified for this product and certified for the country of use.

**Connect and Disconnect Properly.** Connect the probe output to the measurement instrument before connecting the probe to the circuit under test. Disconnect the probe input and the probe ground from the circuit under test before disconnecting the probe from the measurement instrument.

**Ground the Product.** When operating with AC power, this product is grounded through the grounding conductor of the power cord. To avoid electric shock, the grounding conductor must be connected to earth ground. Before making connections to the input or output terminals of the product, ensure that the product is properly grounded.

When operating with battery power, this product must still be grounded. To prevent electric shock, always connect a grounding wire between the ground terminal on the rear panel and earth ground.

**Observe All Terminal Ratings.** To avoid fire or shock hazard, observe all ratings and markings on the product. Consult the product manual for further ratings information before making connections to the product.

Connect the ground lead of the probe to earth ground only.



**Replace Batteries Properly.** Replace batteries only with the proper type and rating specified.

**Recharge Batteries Properly.** Recharge batteries for the recommended charge cycle only.

**Do Not Operate Without Covers.** Do not operate this product with covers or panels removed.

**Use Proper Fuse.** Use only the fuse type and rating specified for this product.

**Avoid Exposed Circuitry.** Do not touch exposed connections and components when power is present.

**Do Not Operate With Suspected Failures.** If you suspect there is damage to this product, have it inspected by qualified service personnel.

**Do Not Operate in Wet/Damp Conditions.**

**Do Not Operate in an Explosive Atmosphere.**

**Keep Product Surfaces Clean and Dry.**

**Provide Proper Ventilation.** Refer to the manual's installation instructions for details on installing the product so it has proper ventilation.

## Safety Terms and Symbols

**Terms in This Manual.** These terms may appear in this manual:



---

**WARNING.** *Warning statements identify conditions or practices that could result in injury or loss of life.*

---



---

**CAUTION.** *Caution statements identify conditions or practices that could result in damage to this product or other property.*

---

**Terms on the Product.** These terms may appear on the product:

**DANGER** indicates an injury hazard immediately accessible as you read the marking.

**WARNING** indicates an injury hazard not immediately accessible as you read the marking.

**CAUTION** indicates a hazard to property including the product.

**Symbols on the Product.** These symbols may appear on the product:



**WARNING**  
High Voltage



Protective Ground  
(Earth) Terminal



**CAUTION**  
Refer to Manual

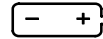

Battery  
Information

## Preventing Electrostatic Damage



---

**CAUTION.** *Electrostatic discharge (ESD) can damage components in the oscilloscope and its accessories. To prevent ESD, observe these precautions when directed to do so.*

---

**Use a Ground Strap.** Wear a grounded antistatic wrist strap to discharge the static voltage from your body while installing or removing sensitive components.

**Use a Safe Work Area.** Do not use any devices capable of generating or holding a static charge in the work area where you install or remove sensitive components. Avoid handling sensitive components in areas that have a floor or benchtop surface capable of generating a static charge.

**Handle Components Carefully.** Do not slide sensitive components over any surface. Do not touch exposed connector pins. Handle sensitive components as little as possible.

**Transport and Store Carefully.** Transport and store sensitive components in a static-protected bag or container.

## Battery Recycling

This product may contain an optional Nickel Cadmium (NiCad) battery, which must be recycled or disposed of properly. For the location of a local battery recycler in the U.S. or Canada, please contact:

RBRC  
Rechargeable Battery Recycling Corp.  
P.O. Box 141870  
Gainesville, Florida 32614

(800) BATTERY  
(800) 227-7379  
[www.rbrcc.com](http://www.rbrcc.com)

# Preface

This User Manual describes the capabilities, operation, and applications of the TDS3000 Series Digital Phosphor Oscilloscopes. The following table shows you where to find information in this manual.

<b>If you are looking for:</b>	<b>Turn to:</b>
Product overview	<i>Product and Feature Description</i> on page 1–4
Installation information	<i>Connect Power</i> on page 1–10
Basic operating instructions	<i>Front Panel Controls</i> on page 1–18
Details about a product feature	<i>Reference</i> on page 3–1 Look up the front-panel button for the feature
Application examples	<i>Application Examples</i> on page 2–1
Information about selecting a language	<i>Configure System</i> on page 3–61
Information about battery operation	<i>Using Battery Power</i> on page 1–10
Information about making a hard copy	<i>Hard Copy</i> on page 3–21
Information about probes and probe-power limitations	<i>Probe Basics</i> on page D–1
Technical specifications	<i>Specifications</i> on page A–1
Recommended accessories	<i>Accessories</i> on page C–1

## Contacting Tektronix

Product Support	<p>For questions about using Tektronix measurement products, call toll free in North America: 1-800-TEK-WIDE (1-800-835-9433 ext. 2400) 6:00 a.m. – 5:00 p.m. Pacific time</p> <p>Or contact us by e-mail: tm_app_supp@tek.com</p> <p>For product support outside of North America, contact your local Tektronix distributor or sales office.</p>
Service Support	<p>Tektronix offers extended warranty and calibration programs as options on many products. Contact your local Tektronix distributor or sales office.</p> <p>For a listing of worldwide service centers, visit our web site.</p>
For other information	<p>In North America: 1-800-TEK-WIDE (1-800-835-9433) An operator will direct your call.</p>
To write us	<p>Tektronix, Inc. P.O. Box 1000 Wilsonville, OR 97070-1000 USA</p>
Website	<p>Tektronix.com</p>





# Getting Started





# Getting Started

In addition to a product and feature description, this chapter covers the following topics:

- How to perform a quick functional check, install and compensate passive probes, and compensate the signal path
- How to install the power cord, battery pack, and operate the oscilloscope safely with battery power
- How to install application modules and communication modules
- How to use the menu system
- How to identify the oscilloscope controls and connectors

## Initial Setup

The following procedures describe how to quickly verify that the oscilloscope is powering up and functioning correctly, compensate passive probes using the built-in compensation signal, and run the signal path compensation (SPC) routine for maximum signal accuracy.

- You should perform all initial setup procedures the first time you use the oscilloscope.
- You should perform the probe compensation procedure whenever you attach a passive probe for the first time to any input channel.
- You should run the signal path compensation routine whenever the ambient temperature changes by 10° C or more.

### Functional Check

Perform this quick functional check to verify that your oscilloscope is operating correctly.

- 
1. Connect the oscilloscope power cable (refer to page 1–9).

- 
2. Turn on the oscilloscope.

Wait for the confirmation that all self tests have passed.

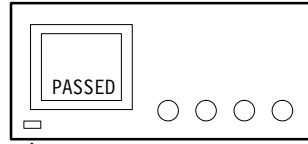

↑  
On/Standby  
button

- 
3. Connect the oscilloscope probe to channel 1. Attach the probe tip and reference lead to the **PROBE COMP** connectors.

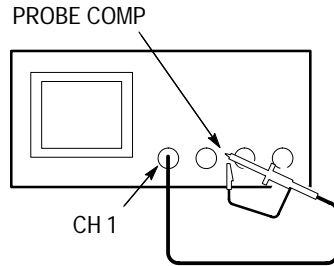

- 
4. Push the **AUTOSET** button. You should see a square wave in the display (approximately 5 V at 1 kHz).

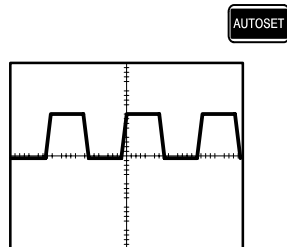

### Probe Compensation

Perform this adjustment to match your probe to the input channel. This should be done whenever you attach a passive probe for the first time to any input channel.

1. Connect the oscilloscope probe to channel 1. Attach the probe tip and reference lead to the **PROBE COMP** connectors, then push **AUTOSET**.

If using the probe hook-tip, ensure a proper connection by firmly twisting the tip onto the probe.

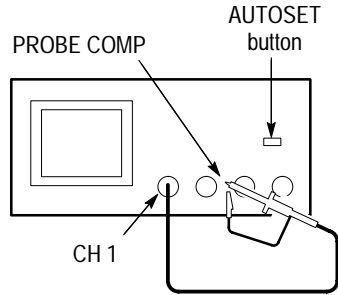

2. Check the shape of the displayed waveform.

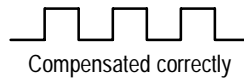

3. If necessary, adjust your probe.

Repeat as necessary.

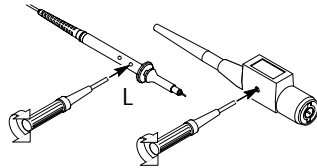

**NOTE.** See Appendix D: Probe Basics for more information about the probes provided with your oscilloscope.

### Signal Path Compensation (SPC)

The signal path compensation (SPC) routine optimizes the oscilloscope signal path for maximum measurement accuracy. You can run the routine anytime but you should always run the routine if the ambient temperature changes by 10° C or more.

To compensate the signal path, do the following steps:

1. Disconnect any probes or cables from the channel input connectors.
2. Push the **UTILITY** button.
3. Push the **System** screen button to select **Cal**.
4. Push the **Signal Path** screen button.
5. Push **OK Compensate Signal Path**. This procedure takes several minutes to complete.

---

***NOTE.** The signal path compensation does not include calibration to the probe tip.*

---

## Product and Feature Description

The TDS3000 Series Digital Phosphor Oscilloscope family consists of the models in the table below.

Model	Bandwidth	Maximum sample rate
TDS3012 (2 Ch), TDS3014 (4 Ch)	100 MHz	1.25 GS/s
TDS3032 (2 Ch), TDS3034 (4 Ch)	300 MHz	2.5 GS/s
TDS3052 (2 Ch), TDS3054 (4 Ch)	500 MHz	5 GS/s

## Acquisition Features

**Separate Digitizers.** Ensure accurate timing measurements with separate digitizers for each channel. Each digitizer can sample at up to the maximum sample rate; acquisition on all channels is always concurrent to provide full single-shot bandwidth on each channel. See page 1–4.

**Normal Acquisition.** Acquire 10,000 point waveforms to capture horizontal detail and then use the zoom  function to analyze the detail. See page 3–11.

**Fast Trigger Acquisition.** Acquire up to 3,000 waveforms per second to see rapidly changing signals or intermittent signal irregularities. See page 3–11.

**Pretrigger.** You can capture signals that occur before the trigger point. You can position the trigger point at the beginning of the acquisition, at the end, or at any location in between. See page 3–25.

**Delay.** You can also delay the acquisition so that it starts after the trigger point. Use delay when you want to acquire the signal at a specific time after the trigger point. See page 3–27.

**Peak Detect.** See pulses as narrow as 1 ns even at the slower time base settings. Peak Detect helps you see noise and glitches in your signal. See page 3–8.

## Signal Processing Features

**Average.** Apply averaging to your signal to remove uncorrelated noise and improve measurement accuracy. See page 3–9.

**Envelope.** Use envelope to capture and display the maximum variation of a signal. See page 3–9.

**Waveform Math.** Use waveform math to add, subtract, multiply, or divide waveforms. For example, you can use math to analyze differential signals or calculate a power waveform. See page 3–74.

## Display Features

**Color LCD Display.** Identify and differentiate waveforms easily with color coding. Waveforms, readouts, and buttons are color matched to increase productivity and reduce operating errors. See page 3–19.

**Digital Phosphor.** A Digital Phosphor Oscilloscope can clearly display intensity modulation in your signals. The oscilloscope automatically overlays subsequent acquisitions and then decays them to simulate the writing and decay of the phosphor in an analog oscilloscope CRT. This feature results in an intensity-graded waveform display that shows the information contained in the intensity modulation. See page 3–5.

**Signal Preview.** Use the preview feature to optimize the control settings when setting up a single-shot acquisition. As you adjust the controls, the adjustments modify the current acquisition to show a preview of how the next acquisition should appear. See page 3–7.

## Measurement Features

**Cursors.** Use cursors to take simple voltage, time, and frequency measurements. See page 3–12.

**Automatic Measurements.** Choose from a list of 21 automatic waveform measurements. You can customize the measurements by changing reference levels or by adding measurement gating. See page 3–33.

## Trigger Features

**Dual Triggers.** Use the main (A) trigger system alone or add the B trigger to capture more complex events. You can use the A and B triggers together to set up a wait-for-time or wait-for-events trigger. See page 3–50.

**Video Trigger.** Trigger on video fields or lines to see a stable display of standard video signals. See page 3–59.

## Convenience Features

**Autoset.** Use Autoset to quickly set up the vertical, horizontal, and trigger controls for a usable display. See page 3–4.

**Scope QuickMenu.** Use the built-in Scope QuickMenu for simplified oscilloscope operation. See page 1–28.

**Single Sequence.** One button sets the trigger parameters to the correct settings for a single-shot acquisition (or single-sequence acquisition). See page 3–3.

**Floppy Disk.** Use the built-in floppy disk to store and recall waveforms and setups, as well as upgrade the oscilloscope firmware and install new features. See page 3–43.

**Probe Support.** Use the standard probes or choose an optional probe for a specific application. See page D–1 for information and limitations.

**Multilingual User Interface.** On-screen menus and messages are in 11 languages. See page 3–61.

## Optional Features

**Application Modules.** Install Advanced Trigger, Extended Video, Telecom Mask Test, or FFT application modules to add new test and measurement features. See page C–2.

**Communication Modules.** Install a communication module to add RS-232, GPIB, VGA, or Ethernet local area network (LAN) ports for remote programmability, sending hardcopy to a LAN printer, or displaying the oscilloscope screen on a monitor. See page 1–17.

**Battery Power.** Install a rechargeable battery pack so you can use the oscilloscope without line power. See page 1–10.

## Transporting the Oscilloscope

When transporting the oscilloscope, wrap the cord around the handle as shown below. Use the supplied cord retainer if the power plug does not have a molded-in retainer. The oscilloscope front cover has a convenient place to store the Reference Manual.

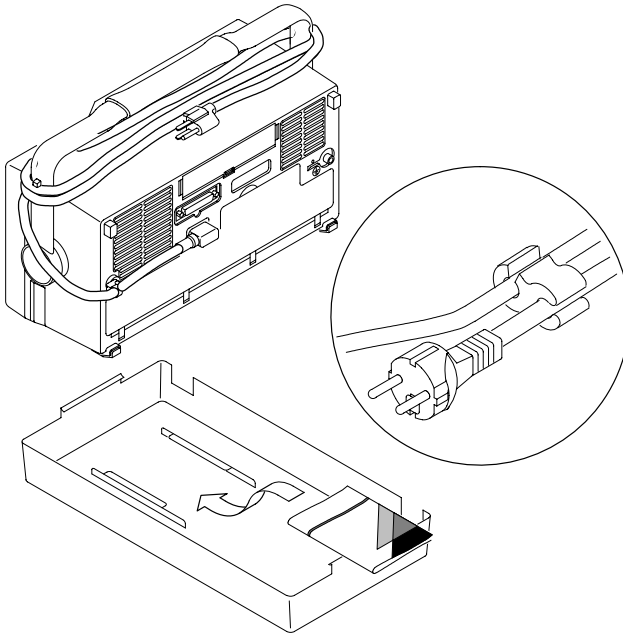

If you are not using a battery, use the accessory tray in the battery compartment to store probes and other accessories.



**CAUTION.** To avoid damage to the disk drive, do not transport the oscilloscope with a floppy disk in the disk drive.

---



## Operating Positions

Use the handle and feet to place the oscilloscope in a convenient operating position.

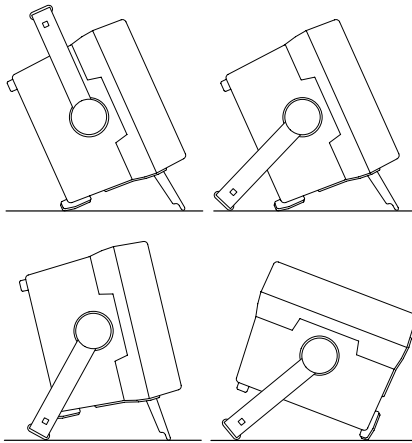

## Connecting Power

To connect a power cord, do these steps:

1. Open the strain relief and slip it over the power cord.
2. Snap the strain relief into its hole in the rear panel of the oscilloscope.
3. Connect the power cord to the power input connector.

You can operate the oscilloscope from a grounded mains supply with line voltage between 90 V<sub>AC</sub> and 250 V<sub>AC</sub> and frequency between 47 Hz and 440 Hz. The oscilloscope is grounded through the power cord. The line fuse is internal and is not user replaceable.

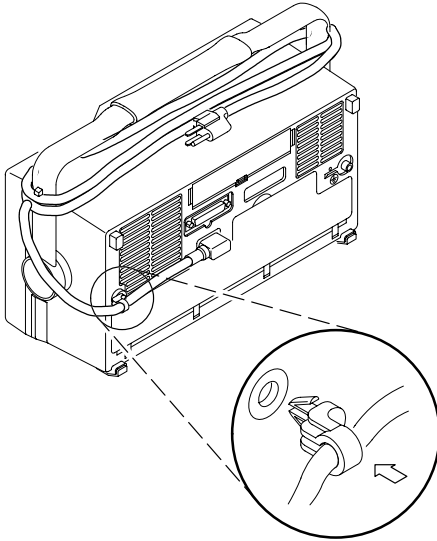

### Using Battery Power

You can operate the oscilloscope continuously for approximately two hours from the rechargeable battery pack. A triangle icon in the display ( $\triangle$ ) shows when the battery is in use, a power-plug icon ( $\text{⏻}$ ) shows when line power is connected, and a gauge icon ( $\text{⏻}$ ) shows the charge level in the battery. The oscilloscope turns off automatically when the battery runs low; the screen may turn white a few minutes before the automatic shutdown.

NiCad batteries appear to lose capacity if not allowed to occasionally discharge completely. Every few months, run your oscilloscope until it shuts down and then recharge the battery completely to keep your battery pack at peak performance.

Refer to the *General Safety Summary* for information about proper nickel-cadmium battery disposal.

---

## Operating Safely with Battery Power

---



**WARNING.** To avoid electric shock, connect the rear-panel ground terminal to earth ground when operating the instrument from battery power.

---

For safe operation, the oscilloscope chassis should always remain at earth ground potential. Without a connection between the chassis and earth ground, you can receive a shock from exposed metal on the chassis if you connect an input to a hazardous voltage ( $>30 V_{RMS}$ ,  $>42 V_{pk}$ ). Protection against this condition is provided when you attach the Tektronix-supplied grounding wire from the terminal on the rear panel to earth ground. If you use a different grounding wire, it must be at least 18 gauge.

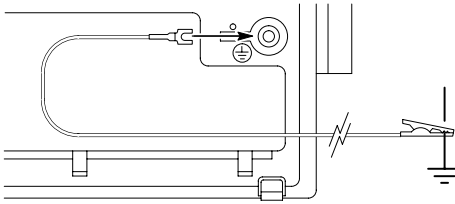

If you choose not to attach the grounding wire, you are not protected against electric shock if you connect the oscilloscope to a hazardous voltage. You can still use the oscilloscope if you do not connect a signal greater than  $30 V_{RMS}$  ( $42 V_{pk}$ ) to either the probe tip or common lead. Ensure that all probe common leads are connected to the same voltage. Also, do not connect a grounded device, such as a printer or computer, to the oscilloscope.



**WARNING.** Hazardous voltages may exist in unexpected places due to faulty circuitry in the device under test.

---

### Installing the Battery

To install the optional battery pack, do these steps:

1. Open the battery compartment door on the rear panel.
2. Remove the accessory tray.

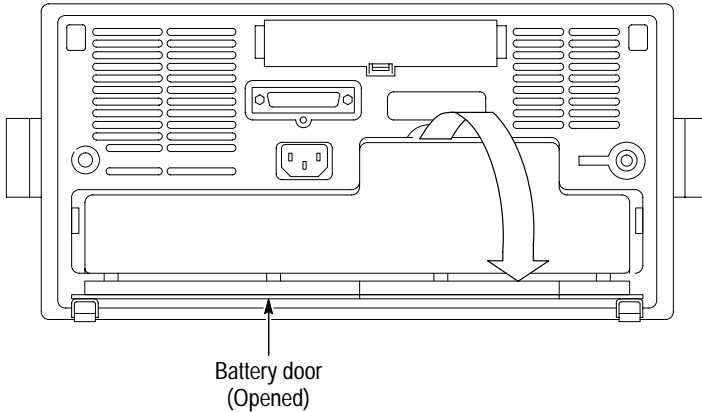

3. Slide the battery into the compartment and press it in from both sides until you hear the latches click.
4. Press on both sides of the battery compartment door to snap it closed.

To remove the battery, do these steps:

1. Open the battery compartment door.
2. Raise the handles on each side of the battery and use them to pull the battery out of the oscilloscope.

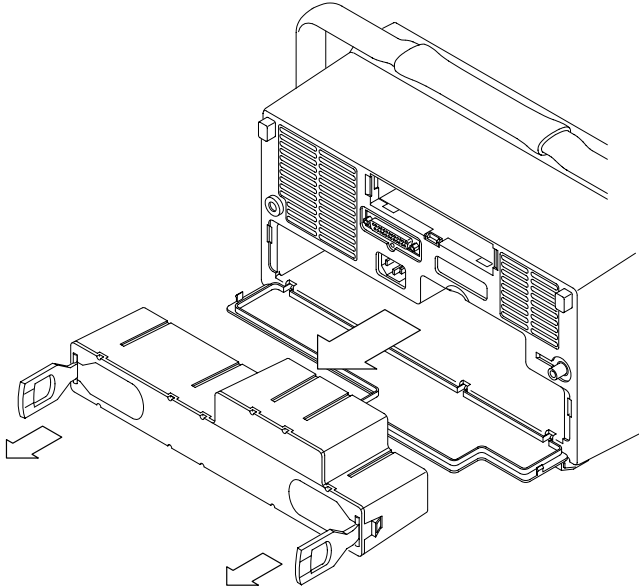

### Maximizing Operating Time

To maximize the time that the oscilloscope can operate from a full battery charge, consider doing these things:

- Reduce the display backlight intensity (see page 3–17)
- Disconnect unused active probes
- Only use passive probes

### Charging the Battery

The battery charges automatically when the oscilloscope is connected to line power. You can also charge the battery with the optional external charger (TDS3CHG).

Configuration	Typical charging time
Battery charging in oscilloscope with oscilloscope turned on or off	18 hours
Battery charging with TDS3CHG external charger	3 hours

---

**NOTE.** Charge the battery before using it for the first time or after prolonged storage.

---

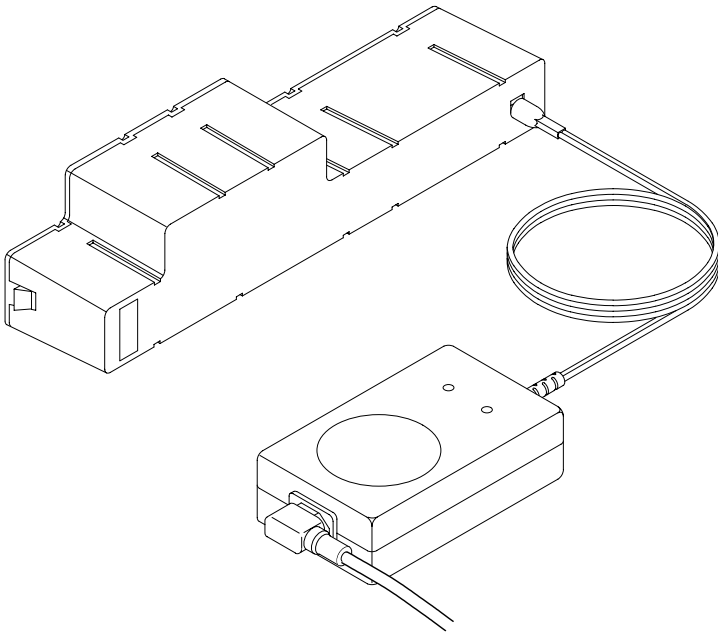

---

## Installing an Application Module

---



**CAUTION.** To avoid damage to the oscilloscope or application module, observe the ESD precautions described on page vii.

---

Optional application packages are available to extend the capability of your oscilloscope. You can install up to four application modules at one time. Application modules can go into the two slots with windows in the upper right corner of the front panel. Two additional slots are hidden behind the two you can see. To install an application module, do these steps:

1. Save any oscilloscope settings and/or reference waveforms to floppy disk before doing these steps.
2. Turn the oscilloscope power off.
3. Open the small door in the upper right corner of the front panel.
4. Use a small screwdriver to remove an existing module if it is necessary to make space for a new application module.
5. Slide the application module into any available slot with the module contacts facing the circuit board. Close the module door.
6. If the application module came with one or more floppy disks, insert the firmware upgrade floppy disk into the disk drive. If there is more than one floppy disk, insert firmware upgrade floppy disk number one into the disk drive.
7. Power on the oscilloscope. The oscilloscope determines whether the firmware update is necessary. If no firmware update is necessary, go to step 9.

8. Push **OK Load New Firmware** to begin loading the firmware. During the process, the oscilloscope may instruct you to insert a second floppy disk. When the firmware upgrade is complete, the oscilloscope will restart automatically with the new firmware.

---

**NOTE.** If you power off the oscilloscope, eject a floppy disk, or there is a power outage during the upgrade process, you must power off the oscilloscope and do the firmware upgrade procedure, starting at step 6, before you can use the oscilloscope.

---

9. Remove the floppy disk.

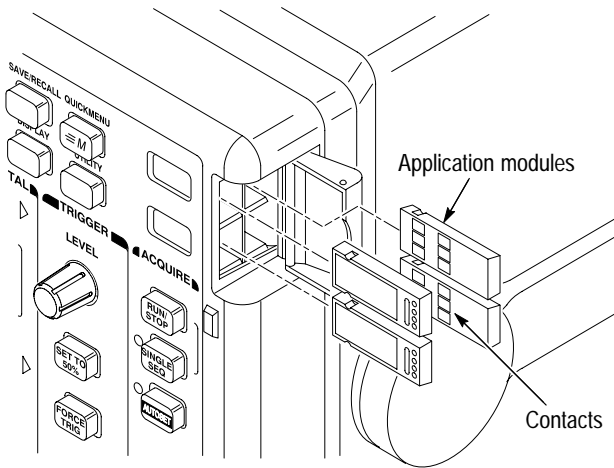

---

**NOTE.** If you remove an application module, the features provided by the application module become unavailable. You can reinstall the module to restore the features.

---



## Installing a Communication Module



**CAUTION.** To avoid damage to the oscilloscope or communication module, observe the ESD precautions described on page vii.

To install one of the optional communications modules, do these steps:

1. Turn the oscilloscope power off.
2. Press down on the latching tab to remove the blank cover.
3. Slide the communication module into the compartment until the internal connectors are seated and the latching tab locks.
4. Turn power on. The communication module is now ready for your use.

To remove a communication module, do these steps:

1. Turn the oscilloscope power off.
2. Press down on the latching tab and then use a small screwdriver to alternately pry out the sides of the communication module.
3. Slide out the communication module and store it in an ESD-shielded bag. Install the blank cover if no other communication module is to be installed.

Communication module port	For more information, see
GPIB	<i>Hard Copy</i> on page 3–21 of this manual and the <i>TDS3000 Series Programmer Manual</i>
RS-232	
Ethernet (LAN) 10BaseT	
VGA	Page A–8 in this manual

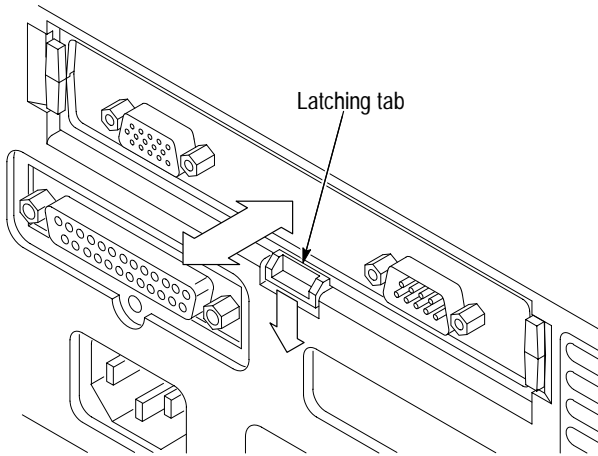

## Front-Panel Menus and Controls

The front panel has buttons and controls for the functions you use most often. The front panel has menus to access more specialized functions.

### Using the Menu System

To use the menu system, follow the steps shown on the next two pages.

1. Push a dark-colored front-panel menu button to display the menu you want to use.

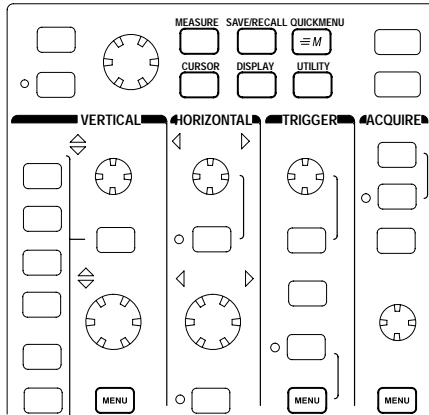

2. Push a bottom screen button to select a menu item. If a pop-up menu appears, continue to push the screen button to select an item from the pop-up menu.

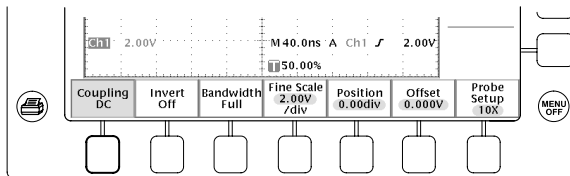

3. Push a side screen button to choose a menu item. If the menu item contains more than one choice, push the side screen button again to make the choice.

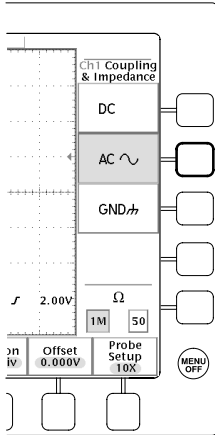

4. Certain menu choices require you to set a numerical value to complete the setup. Use the general purpose knob to adjust the parameter value. Push the COARSE button to make larger adjustments.

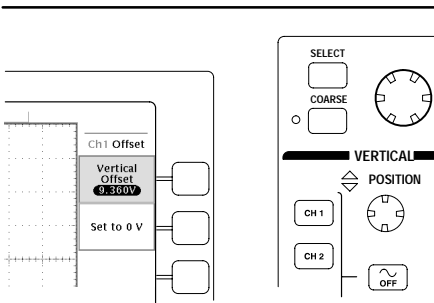

## Using the Menu Buttons

You can use the menu buttons to perform many functions in the oscilloscope.

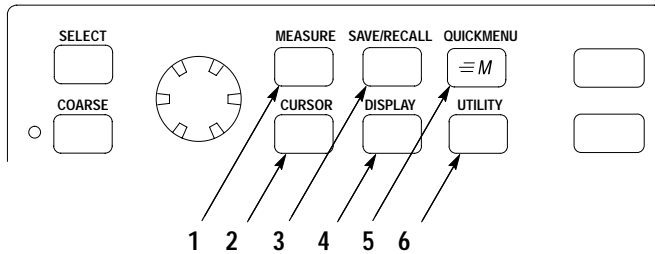

1. **MEASURE.** Performs automated measurements of waveforms.
2. **CURSOR.** Activates the cursors.
3. **SAVE/RECALL.** Saves and recalls setups and waveforms to memory or a floppy disk.
4. **DISPLAY.** Changes the appearance of waveforms and the display screen.
5. **QUICKMENU.** Activates QuickMenus such as the built-in Scope QuickMenu.
6. **UTILITY.** Activates the system utility functions, such as selecting a language.

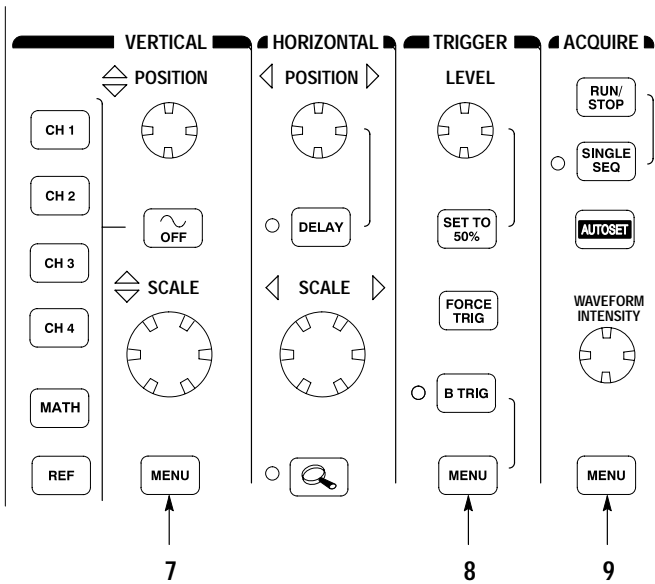

7. Vertical MENU. Adjusts the scale, position, and offset of waveforms. Sets the input parameters.
8. Trigger MENU. Adjusts the trigger functions.
9. Acquire MENU. Sets the acquisition modes and horizontal resolution, and resets the delay time.

### Using the Dedicated Controls

These dedicated buttons and controls generally control waveforms and cursors without the use of menus.

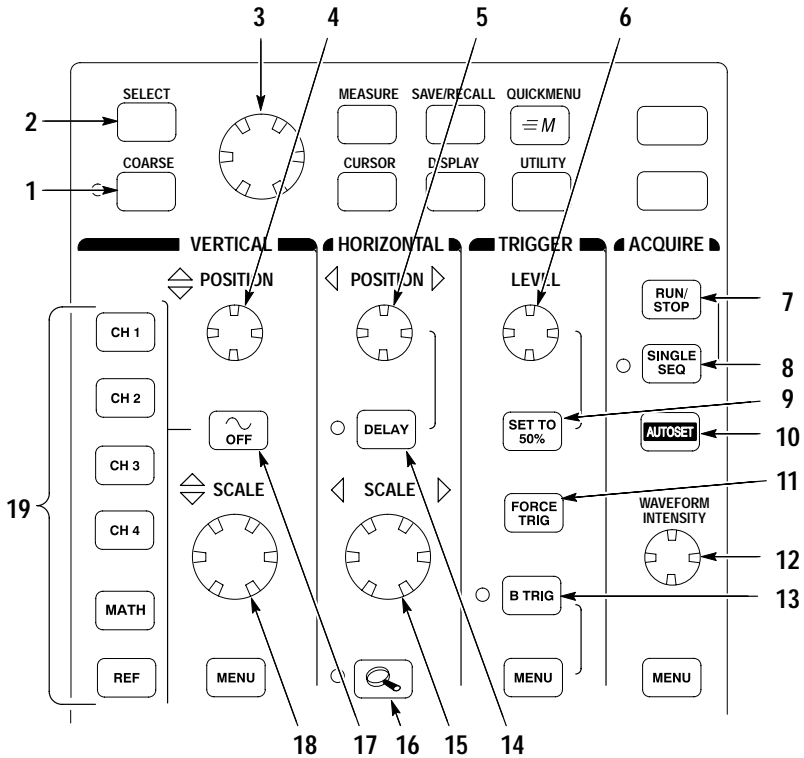

1. **COARSE.** Causes the general purpose knob and position knobs to make adjustments more quickly.
2. **SELECT.** Toggles between the two cursors to select the active cursor.
3. **General purpose knob.** Moves the cursors. Sets numerical parameter values for some menu items. Push **COARSE** to make adjustments quickly.
4. **Vertical POSITION.** Adjusts the vertical position of the selected waveform. Push **COARSE** to make adjustments more quickly.
5. **Horizontal POSITION.** Adjusts the trigger point location relative to the acquired waveforms. Push **COARSE** to make adjustments quickly.
6. **Trigger LEVEL.** Adjusts the trigger level.
7. **RUN/STOP.** Stops and restarts acquisition.
8. **SINGLE SEQ.** Sets acquisition, display, and trigger parameters for a single-shot (single-sequence) acquisition.
9. **SET TO 50%.** Sets the trigger level to the midpoint of the waveform.
10. **AUTOSET.** Automatically sets the vertical, horizontal, and trigger controls for a usable display.
11. **FORCE TRIG.** Forces an immediate trigger event.
12. **WAVEFORM INTENSITY.** Controls waveform intensity.
13. **B TRIG.** Activates the B trigger. Changes the trigger menu to set the B-trigger parameters.
14. **DELAY.** Enables delayed acquisition relative to the trigger event. Use horizontal **POSITION** to set the amount of delay.



15. Horizontal SCALE. Adjusts the horizontal scale factor.
16. Horizontal zoom. Splits the screen and magnifies the current acquisition horizontally.
17. Waveform OFF. Removes selected waveform from the display.
18. Vertical SCALE. Adjusts selected waveform vertical scale factor.
19. CH1, CH2, (CH3, CH4,) MATH. Displays a waveform and chooses the selected waveform. REF shows the reference waveform menu.

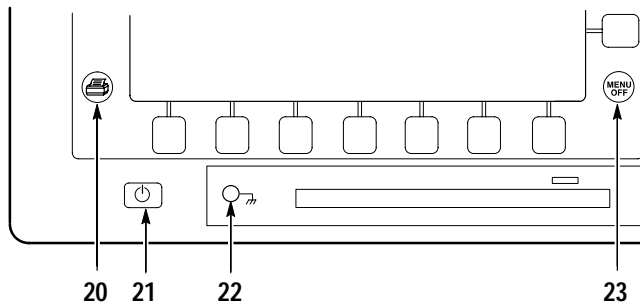

20. Hard copy. Initiates a hard copy using the port selected in the Utility menu.
21. Power switch. Turns power to on or standby. Power-up time varies from about 15 seconds to 45 seconds, depending on the oscilloscope internal calibration process.
22. Wrist-strap ground. Connect a wrist strap when working with ESD-sensitive circuits. This connector is not a safety ground.
23. MENU OFF. Clears menu from the display.

### Identifying Items in the Display

The following items may appear in the display; not all items are visible at any given time. Some readouts move outside the graticule area when menus are turned off.

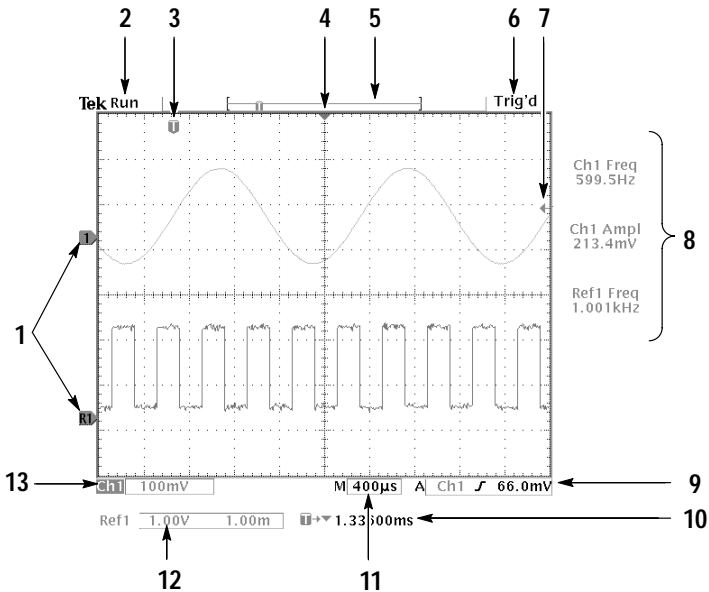

1. Waveform baseline icons show the zero-volt level of the waveforms (ignoring the effect of offset). The icon colors correspond to the waveform colors.
2. Acquisition readout shows when acquisition is running, stopped, or when acquisition preview is in effect.
3. Trigger position icon shows the trigger location in the waveforms.
4. Expansion point icon shows the point that the horizontal scale expands and compresses around.

5. Waveform record icon shows the trigger location relative to the waveform record. The line color corresponds to the selected waveform color.
6. Trigger status readout show trigger status.
7. Trigger level icon shows the trigger level on the waveform. The icon color corresponds to the trigger source channel color.
8. Cursor and measurement readouts show results and messages.
9. Trigger readouts show the trigger sources, slopes, and levels, and position.
10. Readout shows the delay setting or the trigger location within the record.
11. Horizontal readout shows the main or zoom time/division.
12. Auxiliary waveform readouts show the vertical and horizontal scale factors of the math or reference waveforms.
13. Channel readouts show the channel scale factor, coupling, input resistance, bandwidth limit, and invert status.

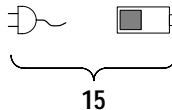
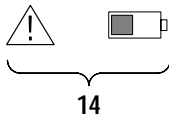

14. Triangle icon with the battery icon indicates a battery is installed and battery power is in use. The battery icon shows the approximate charge level of the battery. See page 1–11 for important safety information.
15. Power-plug icon with the battery icon indicates a battery is installed but line power is in use. The battery may be charging. The battery icon shows the approximate charge level.

### Using QuickMenus

The QuickMenu feature simplifies the use of the oscilloscope. When you push the QUICKMENU button, a set of frequently used menu functions show on the display. Then, push the screen buttons around the display to operate the QuickMenu. See page 3–39 for general instructions to operate QuickMenus.

**Using the Scope QuickMenu.** Scope is one type of QuickMenu that you can use to control the basic oscilloscope functions. You can perform many tasks without using the regular menu system. If you need to use a function that is not contained in the Scope QuickMenu, push the button you would normally push to access that function. For example, if you want to add an automatic measurement, push the MEASURE button to set up the measurement. Then, push the QUICKMENU button to return to the Scope QuickMenu with the measurement also in the display.

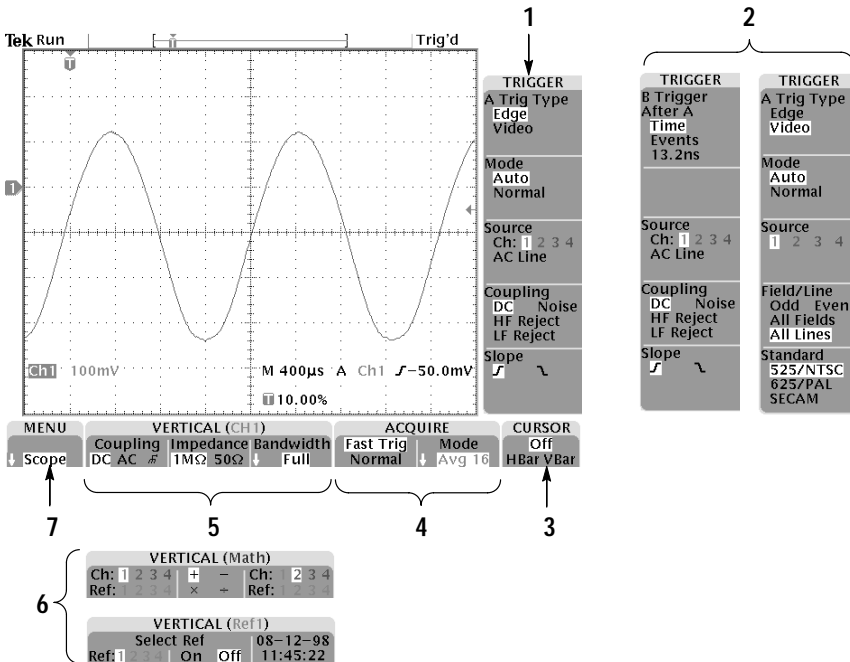

1. Edge Trigger controls. Push these screen buttons to set trigger parameters for edge trigger.
2. Trigger controls if either B trigger or video trigger is selected.
3. Cursor control. Push this screen button to turn on cursors and select the cursor type. Push the SELECT button to toggle between the two cursors to select the active cursor. Use the general purpose knob to move the active cursor.
4. Acquisition controls. Push these screen buttons to set acquisition parameters.
5. Channel vertical controls. Push these screen buttons to set vertical controls for the selected channel. Use the CH1, CH2, CH3, CH4, MATH, and REF buttons to select the channel you want to control.
6. Vertical controls if either the math waveform or a reference waveform is selected.
7. Menu. Push this screen button to select a specific QuickMenu display if more than one is available.

---

**NOTE.** *Items in the Scope QuickMenu not mentioned above are also contained in the regular display. Those items are described on page 1–26.*

---

**Other QuickMenus.** Some optional application packages include a custom QuickMenu display. Those QuickMenus contain specific features that are important for the application.

## Front-Panel Connectors

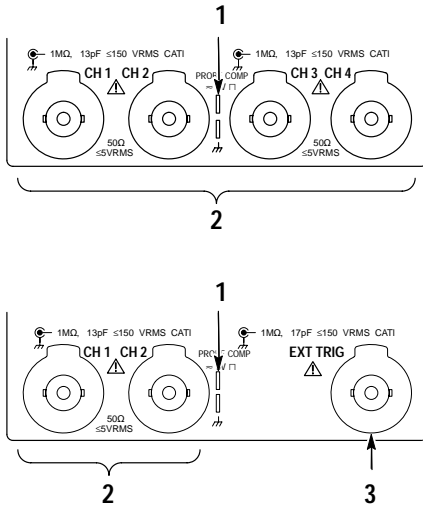

1. PROBE COMP. Square wave signal source to compensate probes.
2. CH 1, CH 2, (CH 3, CH 4). Channel inputs with TekProbe interface.
3. EXT TRIG. External trigger input with TekProbe interface (two-channel models only).

## Rear-Panel Connectors

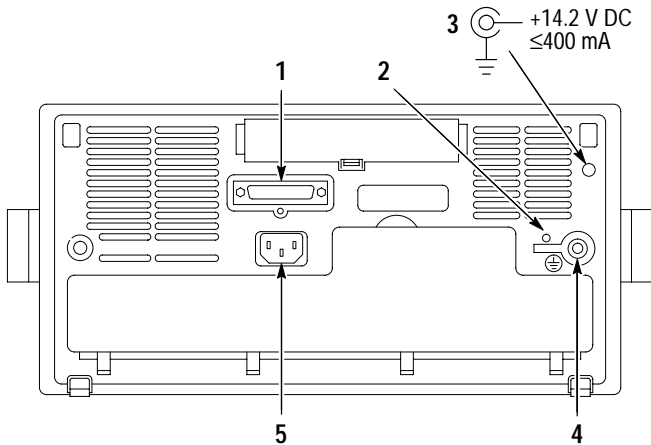

1. Parallel printer port. Connect to a printer to make hard copies.
2. CAL switch. For use by authorized service personnel only.
3. DC power output. Provides ~15 V DC accessory power only when the oscilloscope is connected to the AC power line.
4. Ground terminal. Connect to earth ground when using battery power. See page 1–11 for important safety information.
5. Power input. Attach to an AC power line with integral safety ground.

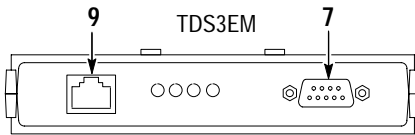
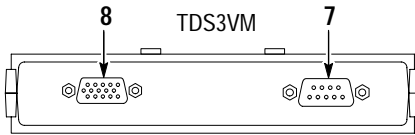
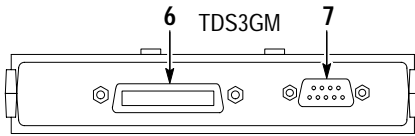

- 6. GPIB port. Connect to a controller for remote programmability.
- 7. RS-232 port. Connect to a controller or terminal for remote programmability or printing.
- 8. VGA port. Connect to a VGA monitor to display the screen image.
- 9. 10baseT local area network (LAN) Ethernet port. Connect to a 10baseT network for remote printing or programming.





# Application Examples





# Application Examples

This section presents five common oscilloscope applications:

- Taking simple measurements
- Analyzing signal detail
- Triggering on a video signal
- Capturing a single-shot signal
- Using the disk drive

Each application example highlights different features of the oscilloscope and gives you ideas about using the oscilloscope to solve test problems.

## Taking Simple Measurements

You need to see a signal in a circuit, but you do not know the signal amplitude or frequency. Connect the oscilloscope to quickly display the signal and then measure its frequency and peak-to-peak amplitude.

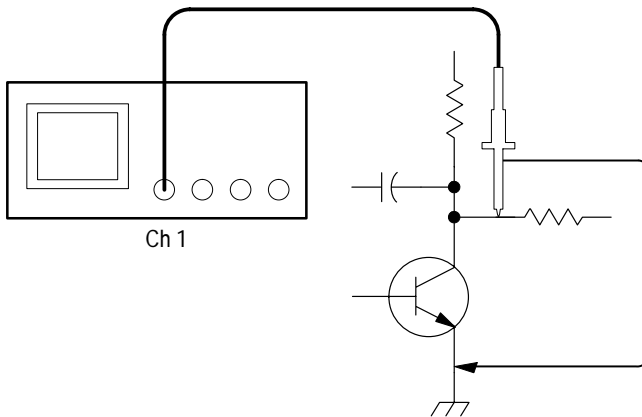

### Using Autoset

To quickly display a signal, do these steps:

1. Connect the channel 1 probe to the signal.
2. Push the **AUTOSET** button.

The oscilloscope sets vertical, horizontal, and trigger controls automatically. You can manually adjust any of these controls if you need to optimize the display of the waveform.

When you are using more than one channel, the autoset function sets the vertical controls for each channel and uses the lowest-numbered active channel to set the horizontal and trigger controls.

### Selecting Automatic Measurements

The oscilloscope can take automatic measurements of most displayed signals. To measure signal frequency and peak-to-peak amplitude, do these steps:

1. Push the **MEASURE** button to see the measurement menu.
2. Push the **CH 1** button and then push the **Select Measurement for Ch1** screen button.
3. Select the **Frequency** measurement.
4. Push the **more** screen button until you can select the **Pk-Pk** measurement.
5. Push the **MENU OFF** button.

The measurements show on the screen and update as the signal changes.

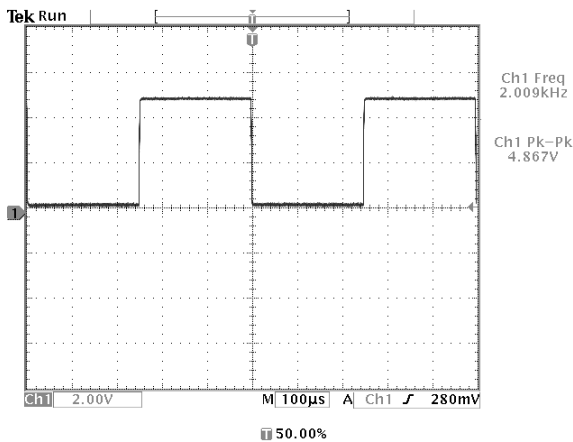

### Measuring Two Signals

You are testing a piece of equipment and need to measure the gain of its audio amplifier. You have an audio generator that can inject a test signal at the amplifier input. Connect two oscilloscope channels to the amplifier input and output as shown. Measure both signal levels and use these measurements to calculate the gain.

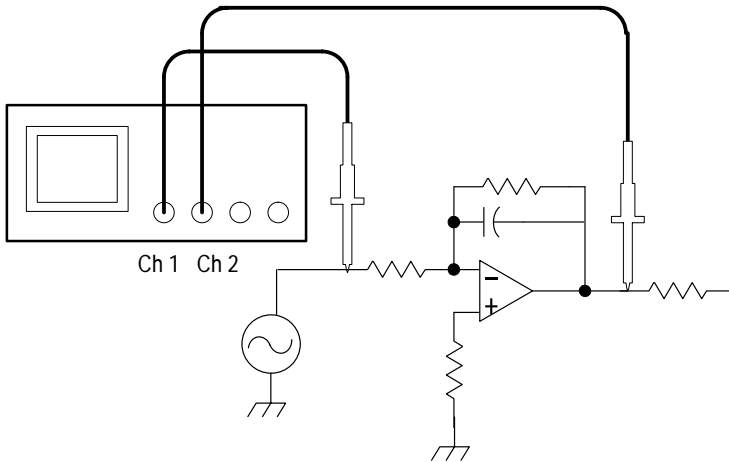

To display the signals connected to channels 1 and 2, do these steps:

1. Push the **CH 1** and **CH 2** buttons to activate both channels.
2. Push the **AUTOSET** button.

To select measurements for the two channels, do these steps:

1. Push the **MEASURE** button to see the measurement menu.
2. Push the **CH 1** button and then push the **Select Measurement for Ch1** screen button.
3. Select the **Amplitude** measurement.
4. Push the **CH 2** button and then push the **Select Measurement for Ch2** screen button.
5. Select the **Amplitude** measurement.

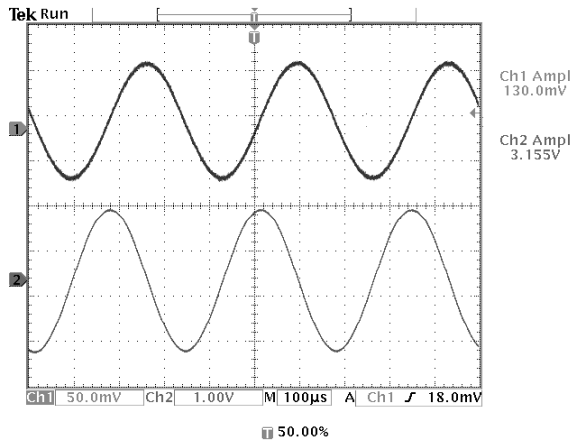

6. Calculate the amplifier gain using the following equations:

$$\text{Gain} = \frac{\text{output amplitude}}{\text{input amplitude}} = \frac{3.155 \text{ V}}{130.0 \text{ mV}} = 24.27$$

$$\text{Gain (dB)} = 20 \times \log(24.27) = 27.7 \text{ dB}$$

### Customizing Your Measurements

In this example you want to verify that the incoming signal to a piece of digital equipment meets its specifications. Specifically, the transition time from a low logic level (0.8 V) to a high logic level (2.0 V) must be 10 ns or less.

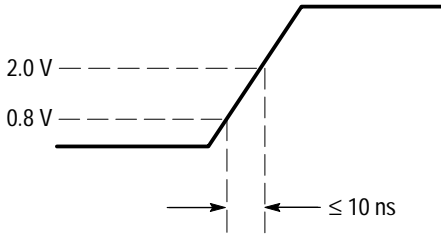

To select the rise time measurement, do these steps:

1. Push the **MEASURE** button to see the measurement menu.
2. Push the **CH 1** button and then the **Select Measurement for Ch1** screen button.
3. Select the **Rise Time** measurement.

Rise time is typically measured between the 10% and 90% amplitude levels of a signal; these are the default reference levels the oscilloscope uses for rise time measurements. However, in this example you need to measure the time the signal takes to pass between the 0.8 V and 2.0 V levels.

You can customize the rise time measurement to measure the signal transition time between any two reference levels. You can set each of those reference levels to a specific percent of the signal amplitude or to a specific level in vertical units (such as volts or amperes).



**Setting Reference Levels.** To set the reference levels to specific voltages, do these steps:

1. Push the **Reference Levels** screen button.
2. Push the **Set Levels in** screen button to select **units**.
3. Push the **High Ref** screen button.
4. Use the general purpose knob to select **2.0 V**.
5. Push the **Low Ref** screen button.
6. Use the general purpose knob to select **800 mV**.

The measurement verifies that the transition time (3.842 ns) meets the specification ( $\leq 10$  ns).

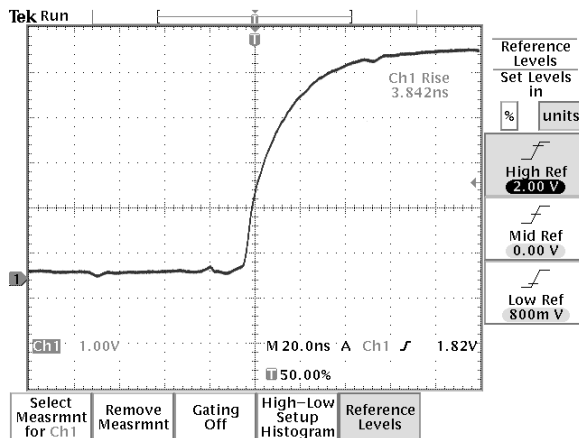

**Measuring Specific Events.** Next you want to see the pulses in the incoming digital signal, but the pulse widths vary so it is hard to establish a stable trigger. To look at a snapshot of the digital signal, do this step:

1. Push the **SINGLE SEQ** button to capture a single acquisition.

Now you want to measure the width of each displayed pulse. You can use measurement gating to select a specific pulse to measure. To measure the second pulse, for example, do these steps:

1. Push the **MEASURE** button.
2. Push the **CH 1** button and then push the **Select Measurement for Ch1** screen button.
3. Select the **Positive Width** measurement.
4. Push the **Gating** screen button.
5. Select **Gate With V Bar Cursors** to choose measurement gating using cursors.
6. Place one cursor to the left and one cursor to the right of the second pulse.

The oscilloscope shows the width measurement (160 ns) for the second pulse.

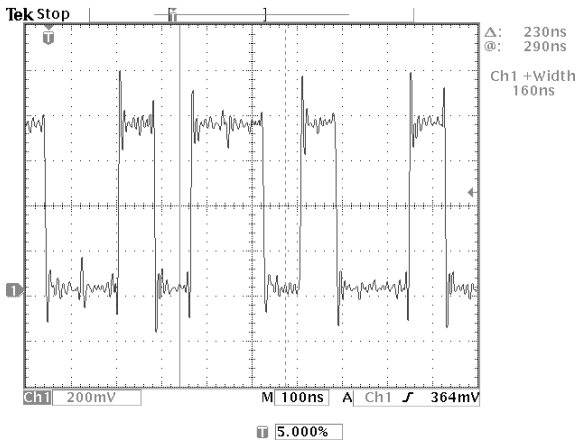

## Analyzing Signal Detail

You have a noisy signal displayed on the oscilloscope and you need to know more about it. You suspect that the signal contains much more detail than you can now see in the display.

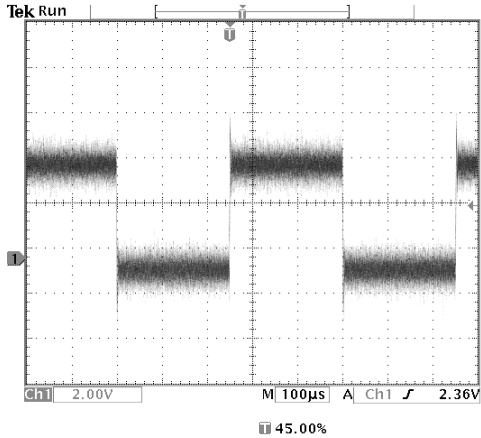

### Looking at a Noisy Signal

The signal appears noisy and you suspect that noise is causing problems in your circuit. To better analyze the noise, do these steps:

1. Push the acquire **MENU** button.
2. Select the **Peak Detect** acquisition mode.
3. Increase the **WAVEFORM INTENSITY** control to see the noise more easily.

Peak detect emphasizes noise spikes and glitches in your signal as narrow as 1 ns, even when the time base is set to a slow setting.

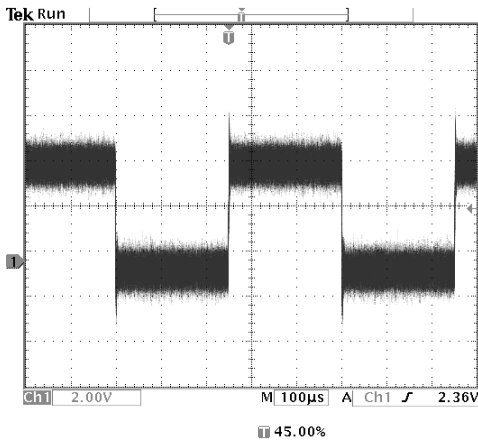

Refer to page 3–8 for more information about peak-detect and the other acquisition modes.

## Separating the Signal from Noise

Now you want to analyze the signal shape and ignore the noise. To reduce random noise in the oscilloscope display, do these steps:

1. Push the acquire **MENU** button.
2. Select the **Average** acquisition mode.

Averaging reduces random noise and makes it easier to see detail in a signal. In the example below, a ring shows on the rising and falling edges of the signal when the noise is removed.

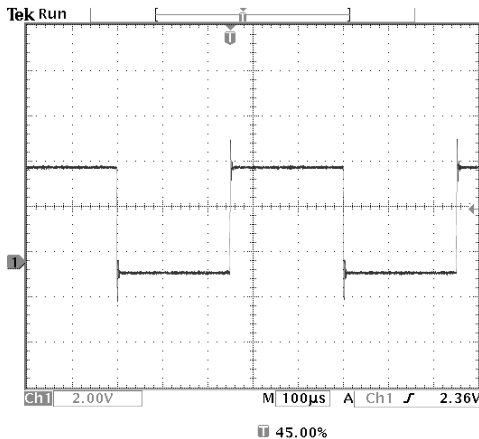

### Taking Cursor Measurements

You can use the cursors to take quick measurements on a waveform. To measure the ring frequency at the rising edge of the signal, do these steps:

1. Push the **CURSOR** button.
2. Push the **Function** screen button.
3. Select **V Bars** cursors.
4. Push the **V Bar Units** screen button.
5. Select **1/seconds (Hz)**.
6. Place one cursor on the first peak of the ring using the general purpose knob.
7. Push the **SELECT** button.
8. Place the other cursor on the next peak of the ring.

The cursor  $\Delta$  readout shows the measured ring frequency is 227 kHz.

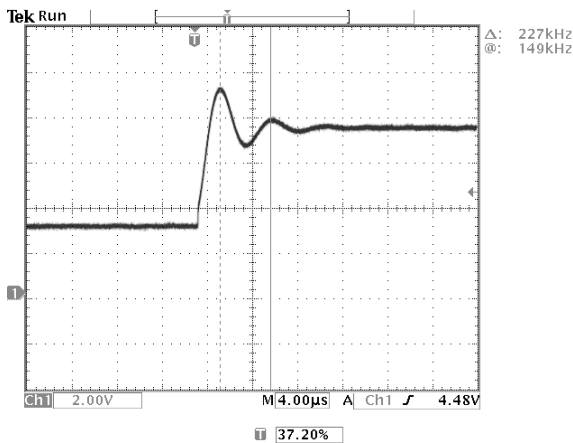

## Using Delay

You are analyzing a pulse waveform and use the + Width measurement to measure the waveform pulse width. You notice that the measurement is not stable, which implies that there is jitter in the pulse width.

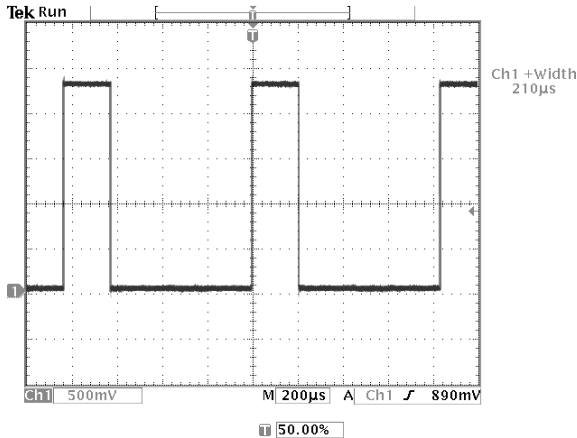

To use delay to see the jitter, do these steps:

1. Push the **DELAY** button.
2. Adjust the horizontal **POSITION** control to set the delay close to the nominal pulse width (210 µs). Push the **COARSE** button to make delay adjustments more quickly. Push **COARSE** again to fine tune the delay time.

The falling edge of the pulse is now near the center of the screen. When delay is on, the horizontal expansion point separates from the trigger point and remains in the center of the screen.

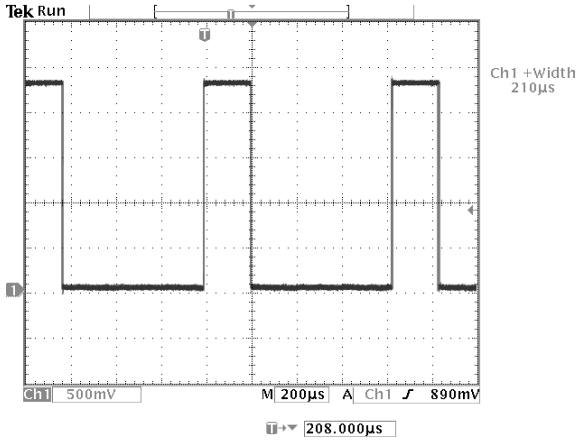

3. Adjust the horizontal **SCALE** to a faster time base setting and increase the **WAVEFORM INTENSITY** to see the jitter in the pulse width.

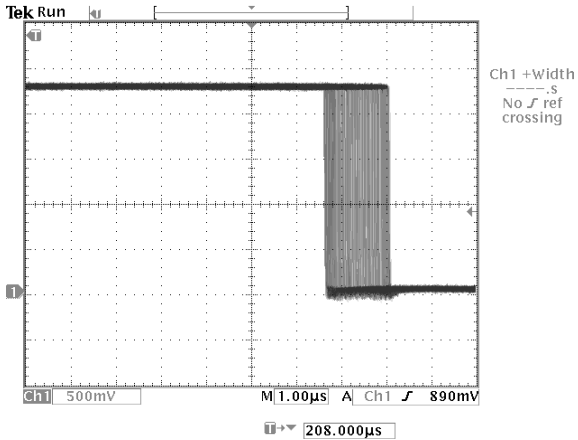

---

**NOTE.** You can toggle the delay function on and off to view signal details at two different areas of interest.

---



### Measuring Jitter

To measure the peak-to-peak jitter, do these steps:

1. Push the **CURSOR** button.
2. Push the **Function** screen button.
3. Select the **V Bars** cursors.
4. Push the **Bring Both Cursors On Screen** screen button to quickly locate the cursors.
5. Place one cursor at the first falling edge and place the other cursor at the last falling edge.
6. Read the peak-to-peak jitter in the  $\Delta$  readout ( $1.40 \mu\text{s}$ ).

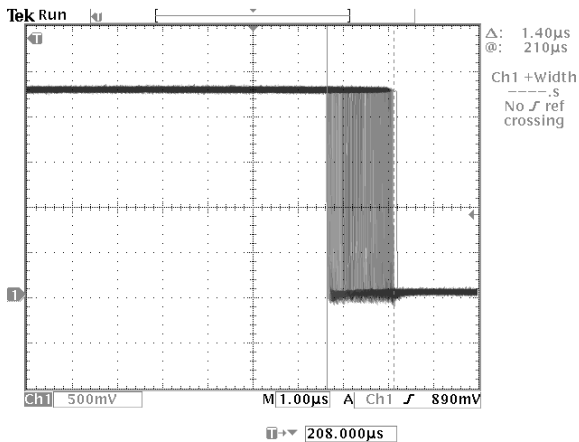

You can also measure the minimum and maximum pulse widths. When you select the first cursor, the @ readout displays the minimum pulse width ( $210 \mu\text{s}$ ). When you select the second cursor, the @ readout displays the maximum pulse width ( $211 \mu\text{s}$ ).

## Triggering on a Video Signal

You are testing the video circuit in a piece of medical equipment and need to display the video output signal. The video output is an NTSC standard signal. Use the video trigger to obtain a stable display.

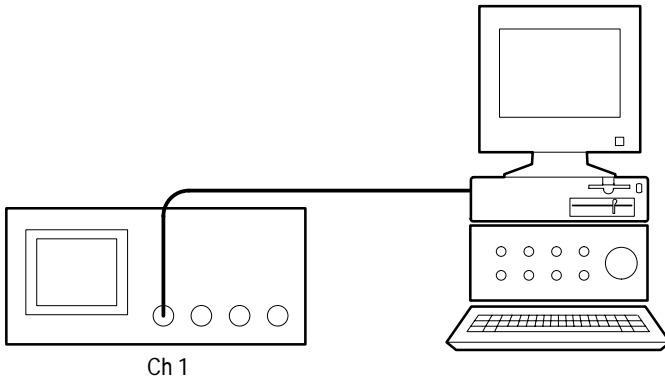

To trigger on the video fields, do these steps:

1. Push the trigger **MENU** button.
2. Push the **Type** screen button to select **Video**.
3. Push the **Standard** screen button to select **525/NTSC**.

4. Push the **Trigger On** screen button.
5. Select **Odd**.
6. Adjust the horizontal **SCALE** to see a complete field across the screen.
7. Push the acquire **MENU** button.
8. Push the **Resolution** screen button.
9. Select **Normal** acquisition resolution.

Normal acquisition resolution is the best choice to acquire a video field signal because the signal contains a great amount of horizontal detail.

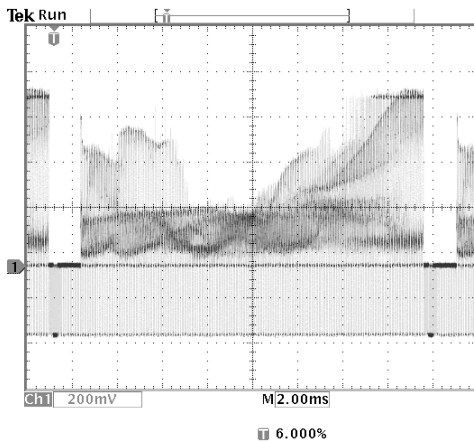

If the signal had been noninterlaced, you could choose to trigger on All Fields.

**Triggering on Lines.** You can also look at the video lines in the field. To trigger on the lines, do these steps:

1. Push the **Trigger On** screen button.
2. Select **All Lines**.
3. Adjust the horizontal **SCALE** to see a complete video line across the screen.

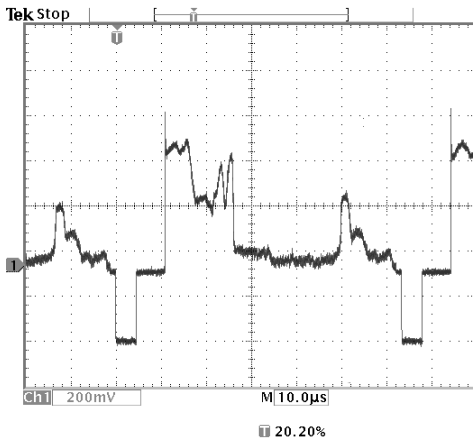

---

**NOTE.** The optional *Extended Video Application Package* adds, among other things, a *video QuickMenu*, *video Autoset*, the capability to operate at custom scan rates, and trigger on specific video lines.

---

**Looking at Modulation.** A dedicated video waveform monitor clearly shows the modulation in a video signal. To see a similar modulation display on the oscilloscope screen, do these steps:

1. Start with triggered display of the video lines.
2. Push the acquire **MENU** button.
3. Push the **Resolution** screen button.
4. Select **Fast Trigger** acquisition resolution.
5. Adjust the **WAVEFORM INTENSITY** control for the amount of modulation you want to see.

The oscilloscope now shows signal modulation in shades of intensity and appears similar to the display of a video waveform monitor or an analog oscilloscope. Fast trigger acquisition resolution is the best choice to acquire a video line signal with a rapidly changing shape.

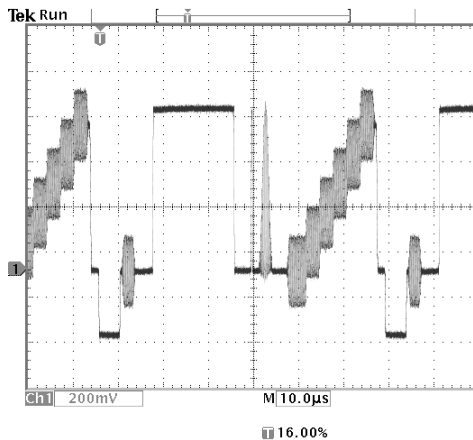

## Capturing a Single-Shot Signal

The reliability of a reed relay in a piece of equipment has been poor and you need to investigate the problem. You suspect that the relay contacts arc when the relay opens. The fastest you can open and close the relay is about once per minute so you need to capture the voltage across the relay as a single-shot acquisition.

To set up for a single-shot acquisition, do these steps:

1. Adjust the vertical **SCALE** and horizontal **SCALE** to appropriate ranges for the signal you expect to see.
2. Push the acquire **MENU** button.
3. Push the **Resolution** screen button.
4. Select **Normal** acquisition resolution.
5. Push the **SINGLE SEQ** (single sequence) button.

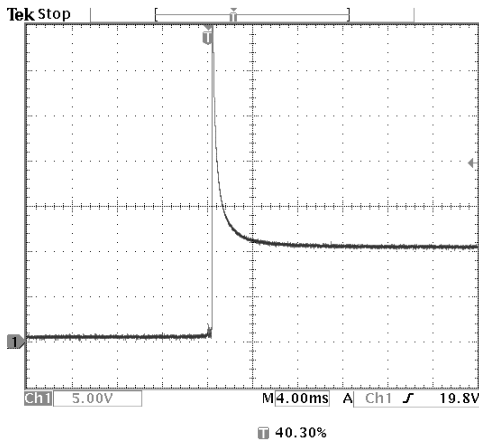

The **SINGLE SEQ** button sets trigger parameters to the correct settings for a single-shot acquisition.

## Optimizing the Acquisition

The initial acquisition shows the relay contact beginning to open at the trigger point. This is followed by a large spike that indicates contact bounce and inductance in the circuit. The inductance can cause contact arcing and premature relay failure.

Before you take the next acquisition, you can adjust the vertical and horizontal controls to give you a preview of how the next acquisition might appear. As you adjust these controls, the current acquisition is repositioned, expanded, or compressed. This preview is useful to optimize the settings before the next single-shot event is captured.

When next acquisition is captured with the new vertical and horizontal settings, you can see more detail about the relay contact opening. You can now see that the contact bounces several times as it opens.

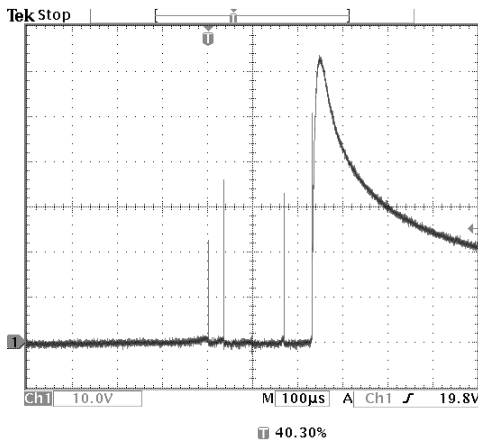

### Using the Horizontal Zoom Function

If you want to take a close look at a particular spot on the acquired waveform, use the horizontal zoom function. To look closely at the point where the relay contact first begins to open, do these steps:

1. Push the zoom button  .
2. Use the horizontal **POSITION** to place the expansion point close to where the relay contact begins to open.
3. Adjust the horizontal **SCALE** to magnify the waveform around the expansion point.

The ragged waveform and the inductive load in the circuit suggest that the relay contact may be arcing as it opens.

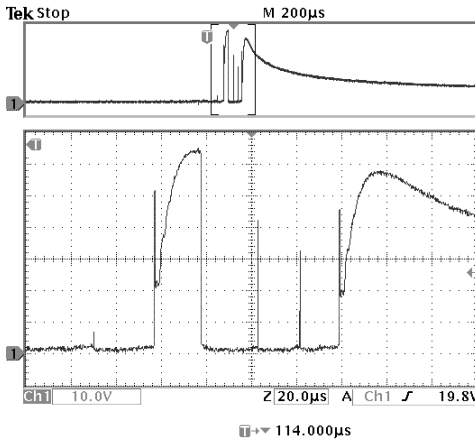

The zoom function works equally well when acquisition is running or is stopped. Horizontal position and scale changes affect only the display, not the next acquisition.



## Using the Disk Drive

You need to do some work inside a remote site. You expect to use the oscilloscope to look at signal waveforms and then bring waveform information back to the office to complete a report and perform additional analysis. To do this, take along an IBM-compatible floppy disk.

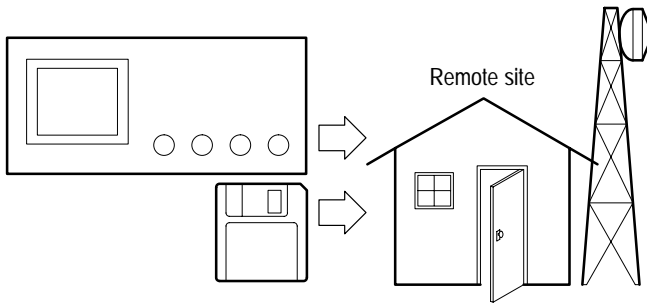

When you need to capture screen images, it may be most convenient to first save them to disk. Once on the disk, you can load the screen images into a PC, print hard copies with a printer attached to the oscilloscope or your PC, or import the screen images into desktop publishing software to produce a report.

You can also save waveform data on the disk. From the disk, you can recall waveforms to the oscilloscope display or you can import the data into spreadsheet and Mathcad software to perform additional analysis.

If you have oscilloscope setups that you want to use again, you also can store them on the disk. See *Save/Recall* on page 3–40 for more information on this capability. For information about remote control of the oscilloscope and network printing, see the AD007 and WSTRO accessories on page C–4.

### Saving Screen Images

While working at the remote site you discover a control signal that you want to capture periodically to show its long-term variation. You want to include these waveforms in a report you are preparing back at the office.

Your desktop publishing software can import BMP graphics, so you decide to use this format for the screen images. To setup this configuration, do these steps:

1. Insert a floppy disk into the disk drive.
2. Push the **UTILITY** button.
3. Push the **System** screen button to select **Hard Copy**.
4. Push the **Format** screen button.
5. Select **BMP Windows mono image file format** (you may need to push the **–more–** screen button several times before you see this choice).
6. Push the **Port** screen button.
7. Select **File** to send hard copies to disk.

The oscilloscope reads the disk directory and displays its contents.

**Naming Files.** It is good practice to give disk files descriptive names so you can recognize them when you get back to the office. You will be saving images of the control signal so you decide CNTRL is a logical target file name to use.

The oscilloscope can append an automatic sequence number to the target file name. This feature is convenient because you want to capture a screen image of the same control signal every five minutes. To set up the target file name and automatic sequence, do these steps:

1. Push the **File Utilities** screen button.
2. Use the general purpose knob to highlight the file **TEK?????.BMP**.
3. Select the **Rename** screen button.
4. Use the screen buttons to clear the existing file name and enter the new file name **CNTRL???.BMP**. The question marks are placeholders for an automatic number sequence from 000 to 999.
5. Push the **OK Accept** screen button to setup the target base file name.
6. Push **MENU OFF** to remove the file list from the display.

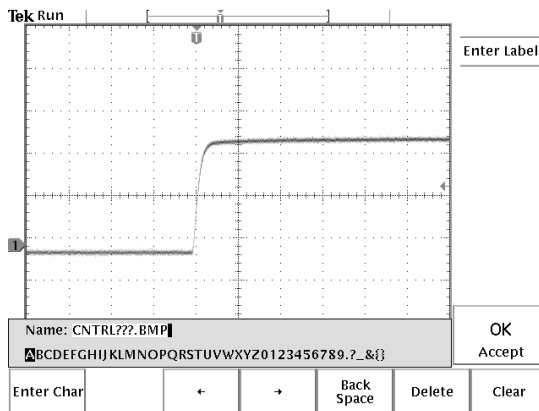

**Running the Test.** To capture the control signal every few minutes, do these steps:

1. Display the signal, measurements, and menus as you want them to appear in the screen images.
2. Push the hardcopy button .
3. Repeat step 2 every few minutes until you are finished with the test.
4. When you are finished, push **UTILITY** to see the list of sequential files that have been saved.

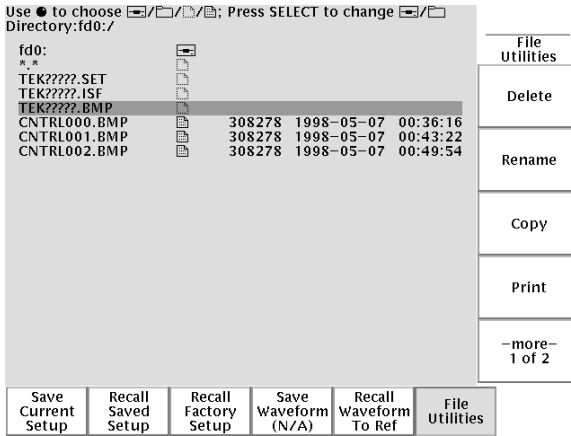

The files are labeled with their sequential names as well as the time and date each was created. You can save up to four BMP images or approximately 35 TIFF images on a single 1.44 MB floppy disk. You can also enable file compression (**UTILITY > System: Hard Copy > Options**) to compress files in zip format so that more files can fit on a floppy disk.

## Saving Waveform Data

You find another signal that you want to analyze with a spreadsheet program back at the office. To save the waveform data on a disk, do these steps:

1. Display the signal on the oscilloscope screen.
2. Push the **SAVE/RECALL** button.
3. Push the **Save Wfm** screen button.
4. Select **To File**.
5. Select **Spreadsheet File Format**. The default target file, TEK?????.CSV, is now automatically highlighted.
6. Push the **Save To Selected File** screen button to save the waveform.
7. Push the **File Utilities** screen button to see the saved waveform file TEK00000.CSV in the disk directory.

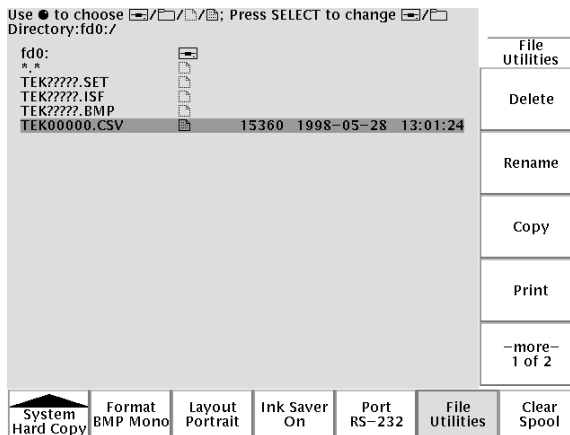





# Reference





# Introduction to Reference

This chapter contains detailed information about the operation of the oscilloscope. The topics in this chapter are arranged by front-panel button or control group name.

Reference topic	Page
Acquire	3-2
Cursor	3-12
Display	3-17
Hard copy	3-21
Horizontal controls	3-25
Measure	3-33
QuickMenu	3-39
Save/Recall	3-40
Trigger controls	3-49
Utility	3-60
Vertical controls	3-70

## Acquisition Controls



**RUN/  
STOP**

### Run/Stop Button

Push the RUN/STOP button to stop and start waveform acquisition. Also push RUN/STOP when you want to resume continuous acquisition after a single-sequence acquisition. Readout in the top left corner of the display shows the status of the acquisition.

Acquisition status readout	Description
Run:	Acquisition is running.
Roll:	A roll-mode acquisition is running.
Stop:	Acquisition is stopped.
PreVu:	Previewing; waiting for trigger.

While acquisition is running or stopped, you can use these controls to examine the waveforms:

- Channel buttons to select a channel
- Zoom button  with horizontal POSITION and SCALE to magnify waveforms (does not affect the actual time base or trigger position settings)
- WAVEFORM INTENSITY to adjust gray-scale level
- CURSOR button to activate cursors to measure waveforms
- MEASURE button to select automatic measurements of waveforms
- Hard copy button  to print a hard copy

While acquisition is stopped, you can change the vertical and horizontal controls to use in the next acquisition. See page 3-7 for more information about this function.

**SINGLE  
SEQ**

### Single Sequence Button

Push the SINGLE SEQ button to execute a single-shot acquisition. The function of the SINGLE SEQ button depends on the acquisition mode.

Acquisition mode	SINGLE SEQ function
Sample or Peak Detect	One acquisition of each displayed channel is acquired, concurrently
Envelope N or Average N	N acquisitions of each displayed channel are acquired (N is user adjustable with the general purpose knob)

When you push the SINGLE SEQ button, the oscilloscope does the following things:

- The trigger mode is set to Normal
- The trigger system arms and the light next to the SINGLE SEQ button turns on

After the single-sequence acquisition is complete, acquisition stops and the light next to the SINGLE SEQ button turns off.

Push the SINGLE SEQ button again to acquire a new sequence, or push the RUN/STOP button to restart continuous acquisition.



### Autoset Button

Push the AUTOSET button to automatically adjust the vertical, horizontal, and trigger controls for a usable display. You can manually adjust any of these controls if you need to optimize the display.

When you are using more than one channel, the autoset function sets the vertical scale for each channel and positions the channels to prevent overlapping. The autoset function selects the lowest-numbered channel in use and then uses that channel to set the horizontal and trigger controls.

The autoset function also changes the following oscilloscope settings:

- Acquisition mode is set to Sample
- Bandwidth limits are set to Full
- Zoom is turned off
- Trigger is set to Auto mode and minimum holdoff
- Trigger is set to Edge type, DC coupling, and rising slope
- B trigger is turned off
- XY display format is turned off
- Channel 1 is turned on and selected if no active channels are in use

If you push the AUTOSET button by accident, you can undo it with these steps:

1. Push the Acquire **MENU** button.
2. Push the **Autoset** screen button and then push the **Undo Autoset** screen button.



### Waveform Intensity

The WAVEFORM INTENSITY adjusts the intensity of the waveforms in the display.

The term Digital Phosphor represents the way this control simulates the intensity control of an analog oscilloscope. At maximum intensity, all waveform points are displayed at full brightness. As you decrease the intensity, you can see intensity grading in the waveforms. The brightest parts of the waveform are the points most frequently acquired; the dimmer parts represent less frequently acquired points. All points decay in intensity over time unless the display persistence is set to infinite.

Use a medium intensity setting to get an analog-oscilloscope view of time-varying signals and those containing modulation. Use the maximum intensity setting to view the signals the way most digital oscilloscopes display them.

You can turn on display persistence to slow or prevent the decay of the waveform points. With persistence on, you can simulate the function of an analog storage oscilloscope. See page 3–17 for more information about display persistence.

---

**NOTE.** *The waveform intensity may change when you change oscilloscope acquisition modes or horizontal scale settings. Use the INTENSITY knob to readjust waveform intensity.*

---

**Acquire Menu**

Push the Acquire MENU button to show the acquire menu.



Bottom	Side	Description
Mode	Sample	Use for normal acquisition.
	Peak Detect	Detects glitches and reduces the possibility of aliasing.
	Envelope N	Captures variations of a signal over a period of time. (Adjust N with the general purpose knob.)
	Average N	Reduces random or uncorrelated noise in the signal display. (Adjust N with the general purpose knob.)
Horizontal Resolution	Fast Trigger (500 points)	Acquires 500 point waveforms at a fast repetition rate.
	Normal (10k points)	Acquires 10,000 point waveforms with more horizontal detail.
Reset Horizontal Delay	Set to 0 s	Resets the horizontal delay time to zero.
Autoset	Normal Autoset	Executes the autoset function. (Optional application modules may add choices to execute specialized autoset functions.)
	Undo Autoset	Reverts to the settings before the last autoset.

## Key Points

**Vertical and Horizontal Preview.** The vertical and horizontal preview functions let you change the vertical and horizontal controls while acquisition is stopped or while it is waiting for the next trigger. The oscilloscope rescales and repositions the current acquisition in response to the new control settings, and then uses the new settings for the next acquisition.

Preview helps you optimize these control settings before the next acquisition; this makes it easier to work with signals that are single-shot or have a low repetition rate.

- For more information about vertical preview, see page 3–73.
- For more information about horizontal preview, see page 3–30.

While acquisition is stopped you can make changes to other controls, but those changes will only take affect with the next acquisition. There is no preview for control changes other than the vertical and horizontal controls.

The preview functions also do not affect automatic measurements, cursor measurements, or the Math waveform. This data for these functions is always based on the current acquisition. If you rescale or reposition a channel waveform horizontally, it may not appear time-correlated to the automatic measurements, cursor measurements, or the Math waveform.

**Acquisition Modes.** You can choose one of four acquisition modes: Sample, Peak Detect, Envelope, or Average. The next two pages describe these acquisition modes in detail.

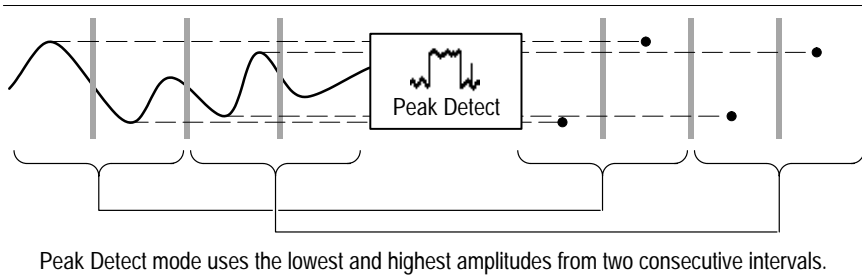
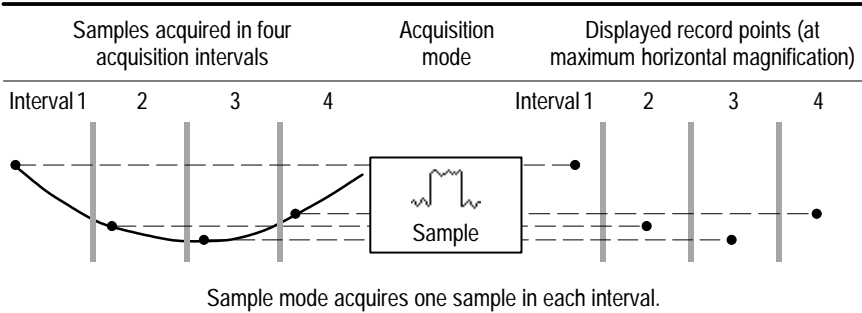

**Sample.** Use Sample acquisition mode for the fastest acquisition at any SEC/DIV setting. Sample mode is the default mode.

**Peak Detect.** Use Peak Detect acquisition mode to limit the possibility of aliasing. Also, use Peak Detect for glitch detection. You can see glitches as narrow as 1 ns.

Peak Detect is only functional for sample rates up to 125 MS/s. For 250 MS/s and faster sample rates, the oscilloscope reverts to Sample acquisition mode, where the narrowest detectable pulse width is  $1/(\text{sample rate})$ .



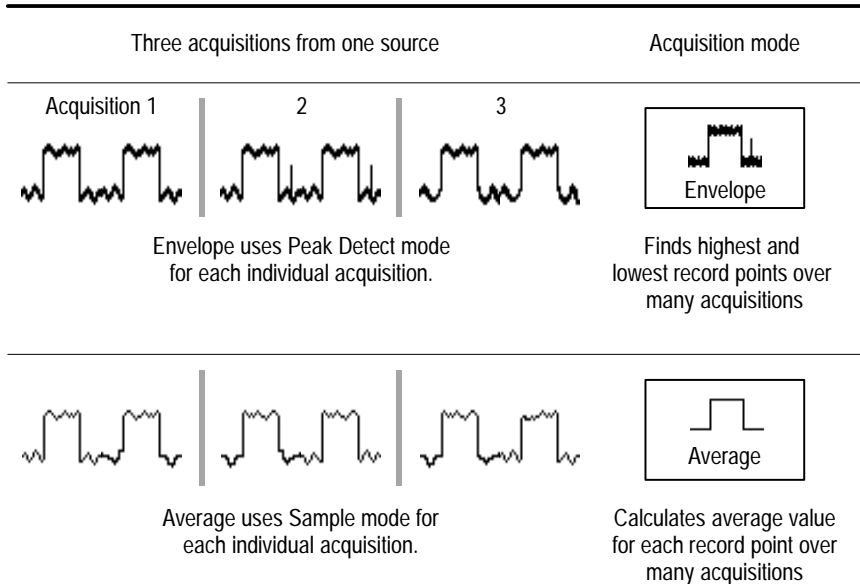

**Envelope.** Use Envelope acquisition mode to capture the minimum and maximum extremes of a signal over a specified number of acquisitions (N). The enveloped waveform data acquisition clears and then starts over after each N acquisitions. If you push the SINGLE SEQ button, envelope acquisition stops after N acquisitions. Use the general purpose knob to set the number of acquisitions.

**Average.** Use Average acquisition mode to reduce random or uncorrelated noise in the signal you want to display. The averaged waveform is a running average over a specified number of acquisitions (N). If you push the SINGLE SEQ button, average acquisition stops after N acquisitions. Use the general purpose knob to set the number of acquisitions.

If you probe a noisy square wave signal that contains intermittent, narrow glitches, the waveform displayed will vary depending on the acquisition mode you choose.

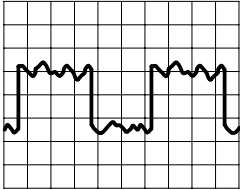

Sample

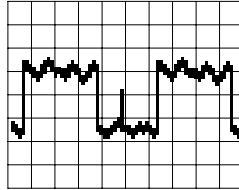

Peak Detect

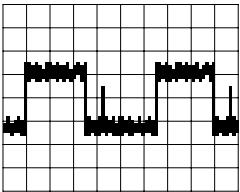

Envelope

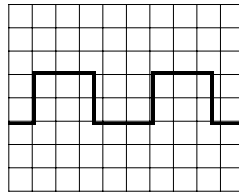

Average

**Acquisition Resolution.** You can choose either Normal or Fast Trigger acquisition resolution. This setting determines the record length that is acquired and affects the other factors shown in the table below.

Factor	Normal	Fast trigger
Record length	10,000 points	500 points
Maximum acquisition rate (approximate)	450 waveforms/s	3,000 waveforms/s
Maximum horizontal zoom factor	200X	10X

Choose Normal or Fast Trigger acquisition resolution based on the characteristics of the signal you want to acquire.

Signal characteristic	Better choice
Large amount of horizontal detail	Normal
Shape is stable or changes relatively slowly	Normal
Single shot	Normal
High trigger repetition rate	Fast Trigger
Shape changes rapidly	Fast Trigger
Contains modulation	Fast Trigger

## Cursor

Push the CURSOR button to show the cursor menu.

CURSOR 	<b>Bottom</b>	<b>Side</b>	<b>Desription</b>
	Function	Off	Turns cursors off.
		H Bars	Use to make vertical measurements.
		V Bars	Use to make both vertical and horizontal measurements.
		Bring Selected Cursor to Center Screen	Moves the active cursor to center screen.
		Bring Both Cursors On Screen	Moves any off-screen cursor onto the screen.
	Mode	Independent	Sets cursors to move independently.
		Tracking	Sets cursors to move together when cursor 1 is selected.

Bottom	Side	Description
V Bar Units	Sec (s) / 1/sec (Hz)	Sets horizontal units to seconds or frequency (Hz).
	Ratio (%)	Sets V Bar measurement units to percent.
	Phase (°)	Sets V Bar measurement units to degrees.
	Use Cursor Positions as %/°	Sets the V Bar measurement scale so that 0% or 0° is the current position of the left V Bar cursor and 100% or 360° is the current position of the right V Bar cursor.
	Use 5 divs as %/°	Sets the V Bar measurement scale so that 5 screen major divisions is 100% or 360°, where 0% or 0° is -2.5 divisions and 100% or 360° is +2.5 divisions from center vertical graticule.

Bottom	Side	Description
H Bar Units	Base	Sets the H Bar units to be the same as the selected waveform's vertical measurement units (volts, IRE, dB, and so on).
	Ratio (%)	Sets H Bar units to percent.
	Use Cursor Positions as 100%	Sets the H Bar measurement scale so that 0% is the current position of the lowest H Bar cursor and 100% is the current position of the highest H Bar cursor.
	Use 5 divs as 100%	Sets H Bar measurement scale so that 5 screen major divisions is 100%, where 0% is -2.5 divisions and 100% is +2.5 divisions from the center horizontal graticule.

### Key Points

**Cursor Movement.** Use the general purpose knob to move the active cursor. Push the **SELECT** button to change which cursor is active. The active cursor is the solid line.

**Faster Cursor Movement.** Push **COARSE** to set the general purpose knob to make faster cursor movement.

**Finding Cursors.** When using zoom, delay, or the fastest time base settings, the cursors can go off screen. If you want to find them, use the **Bring Both Cursors On Screen** function to move them onto the screen.

**Fine Cursor Movement.** When you magnify the waveform with the zoom function, you can easily set the cursor to any point on the waveform.

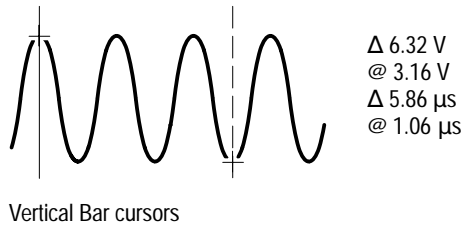
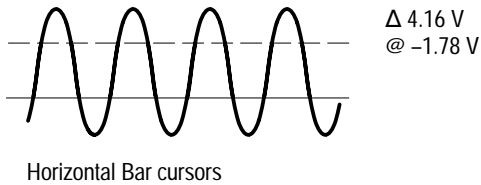

**$\Delta$  Readout.** The  $\Delta$  readouts indicate the difference between the cursor positions.

**@ Readout.** For H Bar or V Bar cursors, the voltage readout after the @ symbol indicates the location of the active cursor relative to zero volts. For V Bar cursors, the time readout after the @ symbol indicates the location of the active cursor relative to the trigger point.

**Cursor Interaction with Preview.** If you change a vertical or horizontal control setting while acquisition is stopped or it is waiting for trigger, the cursors move with the waveforms and cursor measurements remain valid.

**Taking Gray-Scale Measurements.** Using cursors is often the best way to take simple measurements on waveforms that contain significant gray-scale information. The automatic measurements operate only on the latest acquisition, not on the previous acquisitions that are displayed in gray scale. However, you can set the cursors to surround and measure the gray-scale area of the waveform.

**Cursors at Same Position.** If both cursors are at the same position, and H Bars or V Bars are set to Ratio or Phase, both cursors are set to 0% (or 0°). 100%/360° is set to one pixel width away from the cursor position.

**V Bars and FFT.** When the selected waveform is an FFT waveform, selecting V Bars and Phase sets the measurement to percent.

**Tracking Mode.** In cursor tracking mode, both cursors move together when cursor 1 is selected. Enabling tracking mode automatically selects cursor 1 as the active cursor. If cursor 2 is selected while in tracking mode, only cursor 2 will move.



## Display

Push the DISPLAY button to show the display menu.



Bottom	Side	Description
Waveform Display	Dots Only	Set to on to see dots only. Set to off to see dots and vectors.
	Persist Time	Sets persist time.
	Set to Min	Sets the persistence time to its minimum value.
	Clear Persistence	Clears any displayed persistence.
Backlight Intensity	High	Use for bright ambient conditions.
	Medium	Use for dim ambient conditions.
	Low	Use to extend battery-operation time.
Graticule	Full, Grid, Cross Hair, Frame	Sets the graticule type.

Bottom	Side	Description
XY Display	Off (YT)	Turns off an XY display.
	Triggered XY	Turns on triggered XY display.
	Gated XYZ	Turns on gated XY display. Displays XY signals when Z-channel signal is above a set level. Only available on 4-channel instruments.
	Ch1 (X) Versus	Sets Ch2, Ch3, or Ch4 as the Y channel versus Ch1 as X.
	Ref1 (X) Versus or Gated By	Sets Ref2, Ref3, or Ref4 as the Y channel versus Ref1 as X. Sets Ch2, Ch3, or Ch4 as the Z-channel gate source, and sets the gating channel threshold level.
Color Palette	Normal	Selects the color display.
	Monochrome	Sets all waveforms to high-contrast black and white.

**Key Points**

**Waveform Dots and Vectors.** With Dots Only set to off, the vectors between samples can be filled; increase the WAVEFORM INTENSITY control to increase the amount of vector fill between samples. The vector fill is most visible on fast signal edges or when horizontal zoom  is turned on.

Turn Dots Only on if you want to see just the actual samples.

**Waveform Persistence.** Turn on waveform persistence to slow the decay of waveform points. You can set the persistence to a specific time or to infinite. Infinite persistence keeps all waveform points in the display until you change a control setting that erases the display.

**Display Colors.** The channel buttons, waveforms, icons, and readouts are color-coded to help you identify them easily. The colors are preset and cannot be adjusted. However, you can select the Monochrome Color Palette if you prefer to see all the waveforms in high-contrast black and white.

**XY Waveform Triggering.** The XY waveform is triggered so you can synchronize periodic input signals to the XY waveform. This feature is useful when only one part of the period contains valid information that you want to see in the XY format. Set the time base and trigger location to acquire just that part of the period.

When you want to see the complete period of the signals regardless of the time base setting, set the trigger source to an unused channel and the trigger mode to Auto.

**XY Waveform Scale and Position.** If you want to display channel 1 in the horizontal axis versus channel 3 in the vertical axis, for example, use these controls to scale and position the XY waveform:

- Push the CH 1 button and use the vertical SCALE and POSITION controls to set the horizontal scale and position of the XY waveform.
- Push the CH 3 button and use the vertical SCALE and POSITION controls to set the vertical scale and position of the XY waveform.

**XY Waveform Restrictions.** The math waveform, cursor, zoom, and autoset functions do not work in the XY display format. All reference waveforms displayed in XY format must have the same record length (500 or 10,000 points).

**Gated XYZ.** Displays XY signals only when the Z (gating) channel is true. Gated XYZ is similar to analog oscilloscope modulated XYZ mode except that the displayed XY signal is either on or off; there is no intensity modulation. Gated XYZ is useful for showing constellation diagrams.

Push the Gated By screen button to select the Z (gate) source channel.

The general purpose knob sets the Z-channel threshold level. Z-channel signals above the set threshold are true and open the XY signal gate; Z-channel signals below the set threshold are false and close the XY signal gate. The gating channel is always a high-true logic; to emulate a low-true gating logic, use the vertical menu to invert the Z-channel signal.

## Hard Copy



After you connect a printer and set up the oscilloscope, push the hard-copy button at the left of the display to make a hard copy. You can also store hard-copy images on a floppy disk (in normal or compressed format) and then transfer them later to a PC for printing or use in a report.

### Connecting a Printer

Connect your printer to the parallel printer port on the rear panel of the oscilloscope. If you have one of the optional communication modules installed, you can also connect to the serial RS-232 port or the parallel GPIB port if your printer supports one of these interfaces. You can use the optional TDS3EM Ethernet communication module to connect to network printers.

### Setting Up to Print

Follow these steps to set up the oscilloscope to print a hard copy:

1. Push the **UTILITY** menu button.
2. Push the **System** screen button to select **Hard Copy**.
3. Push the **Format** screen button and then choose the printer format appropriate for your application.
4. Push the **Options** screen button to select the image orientation (portrait or landscape) as well as turn on or off hard copy file compression.
5. Push the **Ink Saver** screen button and select **On** for most applications. If you want the hard copy colors to be the same as the screen colors, you can select **Off** (see page 3–23).
6. Push the **Port** screen button and select the port that your printer is connected to or select **File** to save the hard copy on a floppy disk (see page 3–43 for more information about using the floppy disk).
7. Push the hard copy button .

### Key Points

**Printer Formats.** The oscilloscope supports the following printers and file formats.

Format	Description
Thinkjet	HP monochrome ink-jet printer
Deskjet mono	HP monochrome ink-jet printer
Deskjet color	HP color inkjet printer
Laserjet	HP monochrome laser printer
Epson	Epson 9-pin and 24-pin dot matrix printer
Interleaf	*.img Interleaf image object file format
TIFF	*.tif Tag image file format
RLE color	Windows color image file format
PCX mono	PC Paintbrush monochrome image file format
PCX color	PC Paintbrush color image file format
BMP mono	Windows monochrome image file format
BMP color	Windows color image file format
EPS mono	Encapsulated PostScript monochrome image
EPS color	Encapsulated PostScript color image
Bubble Jet	Canon BJC-50, BJC-80 color printers
DPU-3445	Seiko DPU-3445 thermal printer

**Hard Copy File Compression.** When compression is set to on, the oscilloscope compresses the hard copy data, using the current printer format, into a gzip file format, with the extension `.gz`. Compressing hard copy files lets you store more screen captures on a floppy disk. Centronics output is never compressed. `.gz` files can be decompressed using PKZIP™ or WinZip™ programs.

**Color and Gray-Scale Printing.** You can print a color hard copy that uses the display colors. Gray-scale waveform information is printed as shades of color. If you have a Deskjet or Laserjet monochrome printer, gray-scale waveform information is printed as a dithered image.

**Ink Saver and Preview.** As an alternative to printing the display colors, turn on the Ink Saver function to print a hard copy with a white background. This function saves printer ink while it preserves the color coding of the waveforms and readouts. Ink saver also works with the monochrome print formats.

Push and hold the Preview screen button to show how the colors will appear on the paper.

**Clear Spool.** You can push the Clear Spool screen button to empty the print spooler to stop a hard copy operation in progress, if the hard copy port connection is not made due to incompatible settings (such as baud rate), or if you lose the hard copy port connection before the hard copy is complete.

**Date and Time Stamp.** To print the current date and time on your hard copies, do these steps:

1. Push the **UTILITY** button.
2. Push the **System** screen button to select **Config**.
3. Push the **Set Date & Time** screen button.
4. Set the **Display Date/Time** to **On** to add the current date and time to the display screen.
5. Push the **Menu Off** button.

**Printer Error Message.** To avoid printer errors, always power on the printer and allow it to complete its initialization process before powering on the oscilloscope. If you see a 'Hard copy device not responding' error message, power the oscilloscope off and then back on, and then try printing again. If the printer still does not work, check that the printer is online, you have selected the correct printer format on the oscilloscope, there are no paper jams, and that the printer cable is firmly connected to the printer and oscilloscope.



## Horizontal Controls

Use the horizontal controls to adjust the time base, adjust the trigger location, and to examine waveform details more closely.



### Horizontal Position Control

When delay is off, the horizontal POSITION control moves the trigger point within the acquired waveforms. You can select full pretrigger, full posttrigger, or any point in between.

Use a pretrigger setting (trigger position near 100% of the record) to acquire waveforms leading up to a trigger event. For example, if you can trigger on an error condition, the waveforms leading up to the error condition might tell you why the error occurred.

Use a posttrigger setting (trigger position near 0% of the record) when you want to acquire waveforms that follow a trigger event. Use a mid-screen setting when you are interested in information both before and after the trigger event.

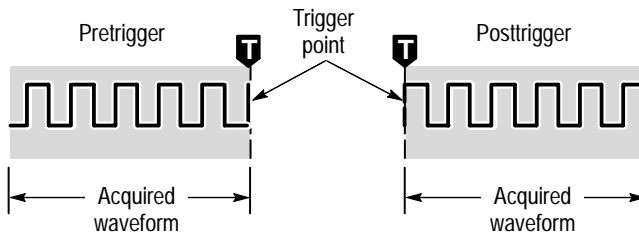

See *Delay Button* on page 3–27 and *Zoom Button* on page 3–29 for information about how the horizontal POSITION control operates when these functions are active.

The trigger position is marked with the letter T at the top of the graticule and also in the waveform record icon at the top of the screen.

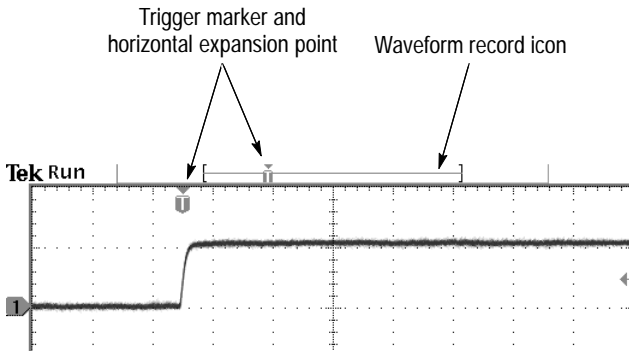

The small inverted triangle is the horizontal expansion point. When you change the horizontal SCALE setting, the waveforms contract or expand about this point. When delay is off, the horizontal expansion point is the same as the trigger point.

**DELAY****Delay Button**

Push the DELAY button when you want to delay the acquisition relative to the trigger event. Turn the horizontal POSITION control counterclockwise to increase the delay; the trigger point moves to the left and ultimately outside of the acquired waveform. Then, you can adjust the horizontal SCALE to acquire more detail around the area of interest (center of the screen).

When delay is on, the trigger point separates from the horizontal expansion point. The horizontal expansion point stays at the center of the screen. The trigger point can move off the screen; when this happens, the trigger marker turns to point in the direction of the trigger point.

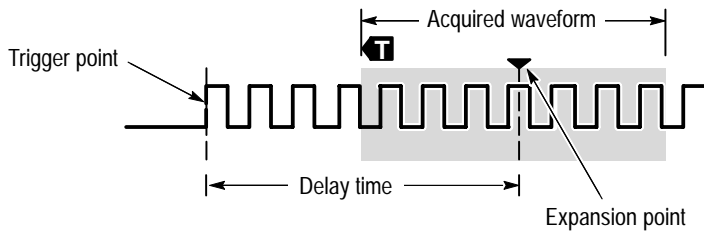

Use the delay feature when you want to acquire waveform detail that is separated from the trigger event by a significant interval of time. For example, you can trigger on a sync pulse that occurs once every 10 ms and then look at high-speed signal characteristics that occur 6 ms after the sync pulse.

In the screen example below, the trigger markers show that the trigger point is before the acquired waveform. The delay time, shown in the readout, is the time from the trigger point to the expansion point (center screen).

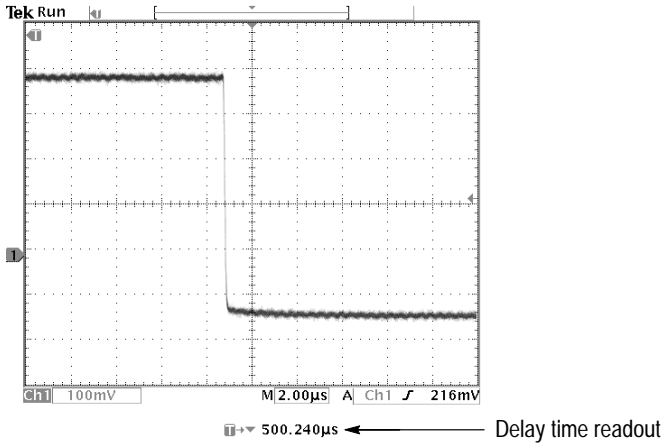

The interaction between delay and other functions is summarized in the table below.

Function	Delay off	Delay on
Trigger point	Any point within the acquired waveform	Can occur prior to the acquired waveform
Expansion point	Same as the trigger point	Always center screen
Horizontal SCALE	Sets time base	Sets time base
Horizontal POSITION	Sets trigger position in the acquired waveform	Sets delay time



### Horizontal Scale Control

Use the horizontal SCALE control to adjust the time base. When delay is off, the scale expands or contracts around the trigger point. When delay is on, the scale expands or contracts around the center of the screen (see *Delay Interactions* on page 3–32 for possible exceptions).

When the zoom function is active, use the horizontal SCALE control to adjust the amount of horizontal magnification (the actual time-base setting remains unchanged). The magnified waveforms always expand or contract around the center of the screen.



### Zoom Button

Push the zoom button to magnify the current acquisition along the horizontal axis so you can see more detail. Use the horizontal SCALE control to adjust the amount of magnification. Use the horizontal POSITION control to select the portion of the waveform you want to magnify. When zoom is on, changes you make to these controls do not affect the actual time base or trigger position settings.

The split screen shows the entire selected waveform in the upper window to give you a point of reference as you examine the details in the lower window.

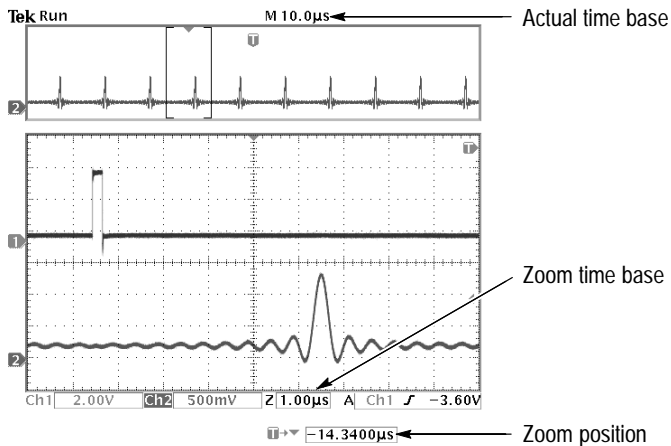

### Key Points

**Maximum Zoom Magnification Factor.** If you are using Normal acquisition resolution, the maximum horizontal magnification factor is 200X; in Fast-trigger the maximum is 10X.

**Horizontal Zoom and Preview.** There are two ways you can magnify a stopped acquisition, horizontal zoom or preview. The differences in how horizontal zoom and preview interact with other functions are shown below.

Function	Horizontal zoom	Horizontal preview
Horizontal SCALE	Sets magnification factor	Changes time base for the next acquisition
Horizontal POSITION	Selects portion of waveform to magnify	Changes trigger position or delay time for the next acquisition
DELAY button	Turns delay on and off	Turns delay on and off
Math waveform	Remains valid; magnifies and positions with other waveforms	Remains fixed; does not track changes to channel waveforms
Cursors and automatic measurements	Remain functional with valid readouts	Remain locked to channel waveforms
Gray-scale	Gray-scale information may be temporarily reduced	Gray-scale information is lost

**Slow Horizontal Settings.** At horizontal SCALE settings of 40 ms/div or slower, the oscilloscope may display waveforms in roll mode. As the rolling waveform fills the screen, the waveform intensity and vector fill appears to decrease. The oscilloscope automatically reduces the number of displayed points in order to maintain a high acquisition rate: this does not represent a loss of acquired data.

When you stop the acquisition, the original waveform intensity and vector fill returns to the display.

**Using Zoom and Delay Together.** You can use both zoom and delay at the same time to magnify a delayed acquisition.

**Fast Time-Base Settings.** At the fastest time-base settings, only a portion of the waveform shows in the display. The waveform record icon indicates that portion with brackets. Push the zoom  button and then use the horizontal POSITION control to scroll through the entire waveform to see any portion you want. The affected time-base settings are shown below.

Acquisition resolution	Affected time-base settings
Normal	100 ns/div to 1 ns/div
Fast Trigger	4 ns/div to 1 ns/div

At the fastest time-base settings, the maximum zoom magnification factor is also reduced.

**Delay Interactions.** The maximum delay setting is a function of the time-base setting and acquisition resolution. If you set a large positive or negative delay, that amount of delay might be automatically reduced if you make the following additional control changes:

- Change to a faster time-base setting
- Change from Fast Trigger to Normal acquisition resolution

If the delay reduction occurs, it may cause the waveform horizontal position to shift.

**Negative Delay.** You can select up to ten divisions of negative delay. At the fastest time base settings, you can use negative delay to see more of the waveform that occurs before the trigger point.

**Roll Mode Display.** To obtain a rolling display similar to a strip-chart recorder, turn off zoom and delay, select the Auto trigger mode, and set the horizontal SCALE control to 40 ms/div or slower. Subsequent changes to the horizontal SCALE cause the roll-mode display to erase and restart.



## Measure

Push the MEASURE button to show the measure menu.

MEASURE



Bottom	Side	Description
Select Measurement		See table on page 3–37 for a description of the automatic measurements.
Remove Measurement	Measurement 1 Measurement 2 Measurement 3 Measurement 4	Removes a specific measurement.
	All Measurements	Removes all measurements.
Gating	Off	Use to take measurements on the full waveform record.
	Screen	Use to take measurements on the portion of the waveform on screen.
	Cursors	Use to take measurements on the portion of the waveform between the V Bar cursors.
	Bring Selected Cursor to Center Screen	Moves the active cursor to center screen.
	Bring Both Cursors On Screen	Moves any off-screen cursor onto the screen.
High-Low Setup	Auto Select	Automatically uses the best measurement method depending on the signal characteristics.
	Histogram	Use to measure pulses.
	Min-Max	Use to measure other wave shapes.

Bottom	Side	Description
Reference Levels	Set Levels in % or units	Use to choose custom reference levels in relative or absolute units.
	High Reference	Sets custom high reference level.
	Mid Reference	Sets custom mid reference level.
	Low Reference	Sets custom low reference level.
	Set to Defaults	Sets reference levels to default values.

### Key Points

**Choosing Measurements.** You can perform up to four automatic measurements and display them along the right side of the graticule. All four measurements can apply to a single channel or you can spread the measurements over several channels. You can also take measurements on math and reference waveforms.

First push a channel, MATH, or REF button to select the waveform you want to measure and then select a measurement. The table beginning on page 3–37 describes the measurements in detail.

**Measurement Interaction with Preview.** If you change a vertical or horizontal control setting while acquisition is stopped or is waiting for trigger, measurements track the changes and remain valid.

**Taking Gray-Scale Measurements.** Using cursors is often the best way to take simple measurements on waveforms that contain significant gray-scale information. The automatic measurements operate only on the latest acquisition, not on the previous acquisitions that are displayed in gray scale. However, you can set the cursors to surround and measure the gray-scale area of the waveform.

**High-Low Setup.** The oscilloscope determines the 10%, 50%, or 90% levels of the waveform and then uses them to calculate the measurements. You can choose the method used to determine these levels:

- Histogram sets the values statistically; it finds the most common value either above or below the midpoint (depending on whether it is defining the high or low reference level). Since this statistical approach ignores short-term aberrations (overshoot, ringing, noise), histogram is the best method for measuring digital waveforms and pulses.
- Min-max uses the highest and lowest values of the waveform record. This method is best for measuring waveforms that have no large, flat portions at a common value, such as sine waves and triangle waves.
- Auto Select chooses one of the above methods automatically depending on the signal characteristics. Auto Select chooses the histogram method if the histogram contains prominent peaks. If not, Auto Select chooses the min-max method.

**Measurement Gating.** You can use the gating feature to limit measurements to the portion of the waveform that is on the screen or between the cursors.

When you turn Screen gating on, the oscilloscope only uses the waveform points on screen in its measurements. This function is useful at the fastest time base settings or when you want to take measurements on a magnified waveform (when zoom  is on).

When you turn Cursor gating on, the oscilloscope displays vertical bar cursors. Use the general purpose knob and SELECT button to place the cursors around the area of interest.



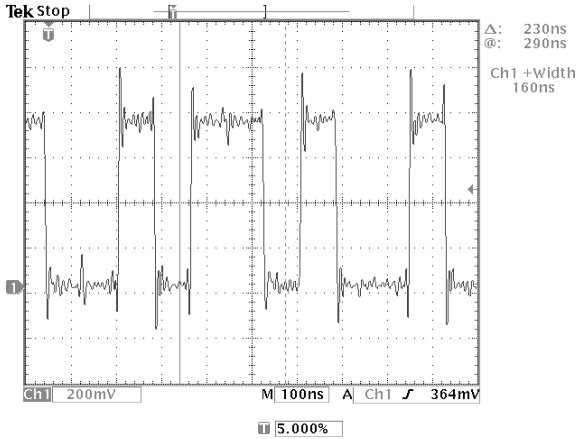







In the example below, the cursors surround the second positive-going pulse so the oscilloscope can measure the width of that pulse.













When gating is off, the oscilloscope takes measurements over the entire waveform record.

**Using Measurement Gating with Cursors.** If V Bar cursors are already on when you select Cursor gating, the cursors do both functions at the same time. The cursor readouts are displayed at the same time that the cursors gate the automatic measurements.

If H Bar cursors are on when you select cursor gating, the H Bar cursors are turned off.

Measurement name	Definition
 <b>Amplitude</b>	Measured over the entire waveform. <i>Amplitude = High (100%) – Low (0%)</i>
 <b>Burst Width</b>	The duration of a burst. Measured over the entire waveform.
 <b>Cycle Mean</b>	The arithmetic mean over the first cycle in the waveform.
 <b>Cycle RMS</b>	The true Root Mean Square voltage over the first cycle in the waveform.
 <b>Fall Time</b>	Time that the falling edge of the first pulse in the waveform takes to fall from 90% to 10% of its amplitude.
 <b>Frequency</b>	Reciprocal of the period of the first cycle in the waveform. Measured in Hertz (Hz).
 <b>High</b>	The value used as 100%. Calculated using either the min/max or the histogram method. Measured over the entire waveform.
 <b>Low</b>	The value used as 0%. Calculated using either the min/max or the histogram method. Measured over the entire waveform.
 <b>Max</b>	The maximum amplitude. The most positive peak voltage measured over the entire waveform.
 <b>Mean</b>	The arithmetic mean over the entire waveform.
 <b>Min</b>	The minimum amplitude. The most negative peak voltage measured over the entire waveform.

Measurement name	Definition
 <b>Negative Duty Cycle</b>	Measurement of the first cycle in the waveform. $\text{Negative Duty Cycle} = \frac{\text{Negative Width}}{\text{Period}} \times 100\%$
 <b>Negative Overshoot</b>	Measured over the entire waveform. $\text{Negative Overshoot} = \frac{\text{Low-Min}}{\text{Amplitude}} \times 100\%$
 <b>Negative Width</b>	Measurement of the first negative pulse in the waveform. The time between the 50% amplitude points.
 <b>Pk-Pk</b>	Measured over the entire waveform. $\text{Peak-to-peak} = \text{Max} - \text{Min}$
 <b>Period</b>	Time it takes for the first complete signal cycle to complete in the waveform. Measured in seconds.
 <b>Positive Duty Cycle</b>	Measurement of the first cycle in the waveform. $\text{Positive Duty Cycle} = \frac{\text{Positive Width}}{\text{Period}} \times 100\%$
 <b>Positive Overshoot</b>	Measured over the entire waveform. $\text{Positive Overshoot} = \frac{\text{Max-High}}{\text{Amplitude}} \times 100\%$
 <b>Positive Width</b>	Measurement of the first positive pulse in the waveform. The time between the 50% amplitude points.
 <b>Rise Time</b>	Time that the leading edge of the first pulse in the waveform takes to rise from 10% to 90% of its amplitude.
 <b>RMS</b>	The true Root Mean Square voltage over the entire waveform.

## QuickMenu

QUICKMENU



Push the QUICKMENU button to see a set of frequently used menu functions on the display. QuickMenus simplify oscilloscope operation and can increase your productivity.

Scope is a standard QuickMenu for general purpose oscilloscope use. Some optional application modules also include a custom QuickMenu display. See page 1–28 for an example of the Scope QuickMenu.

### Key Points

**Using the QuickMenus.** To use a QuickMenu, push the screen button that corresponds to the control you need to set. Push the screen button repeatedly to choose one of the settings. The small arrow icon indicates that there are additional settings available that are not shown.

You can use most of the front-panel controls at the same time you are using a QuickMenu. For example, if you push a channel button to select a different channel, the QuickMenu changes to show information about that channel.

**Using Other Menus.** You can still use the regular menus. For example, if you push the MEASURE button, you can set up and take automatic waveform measurements in the usual way. If you return to the QuickMenu, the measurement is still displayed on the screen.

**Selecting Between QuickMenus.** You may have optional application modules installed that also have QuickMenu displays. To select the QuickMenu you want to use, push the MENU screen button. This menu item is shown only if application modules that contain a QuickMenu are installed.

## Save/Recall

Push the SAVE/RECALL button to show the save/recall menu.

SAVE/RECALL



Bottom	Side	Description
Save Current Setup	To File	Saves a setup to disk.
	To Setup 1 ... To Setup 10	Saves a setup to nonvolatile memory.
Recall Saved Setup	From File	Recalls a setup from disk.
	Recall Setup 1 ... Recall Setup 10	Recalls a setup from nonvolatile memory.
Recall Factory Setup	OK Confirm Factory Init	Initializes the setup.
Save Wfm	To File	Shows file-format choices: Internal, Spreadsheet, or Mathcad (see page 3-44). Saves the selected waveform to disk.
	To Ref1 ... To Ref4	Saves the selected waveform to nonvolatile memory.
Recall Wfm	From File Recall Ref1 ... Recall Ref4	Recalls a waveform from disk and displays it as a reference waveform.
File Utilities	Accesses floppy disk file utilities. Refer to description on page 3-43.	
Labels	Lets you assign unique labels to reference waveforms and instrument setups stored in nonvolatile memory. Refer to page 3-45 for a description of how to edit label text.	



## Key Points

**Saving to Disk.** See *Saved Waveform Formats* on page 3–44 for information about saving to and recalling from the disk.

**Saving Setups.** To save the current setup to nonvolatile memory, push the Save Current Setup screen button and then select one of the ten storage locations. Then, push the OK Overwrite Saved Setup screen button to complete the operation or the MENU OFF button to cancel the operation.

**Recalling Setups.** To recall a setup from nonvolatile memory, push the Recall Setup screen button and then select one of the ten storage locations.

**Recalling the Factory Setup.** Recall the factory setup to initialize the oscilloscope to a known setup. *Appendix B* describes the Factory Setup in detail.

To recall the factory setup, push the Recall Factory Setup screen button. Then, push the OK Recall Factory Setup screen button to complete the operation.

**Saving a Waveform.** To save a waveform to nonvolatile memory, first select the waveform you want to save. Push the Save Wfm screen button and then select one of the four reference waveform locations. See page 3–76 for an alternate method you can use to save waveforms.

Saved waveforms contain only the most current acquisition; gray-scale information, if any, is not saved.

**Displaying a Reference Waveform.** To display a waveform stored in nonvolatile memory, push the REF button and then push the Ref1, Ref2, Ref3, or Ref4 screen button.

When a reference waveform is selected, it appears brighter than other reference waveforms. Reference waveforms do not contain gray-scale information.

**Removing a Reference Waveform from the Display.** To remove a reference waveform from the display, push the REF button and then the Ref1, Ref2, Ref3, or Ref4 screen button to select a reference waveform. Push the waveform off  button. The reference waveform is still in nonvolatile memory and can be displayed again.

**Erasing All Setups and Waveforms.** See *Tek Secure* on page 3–63 for instructions on how to erase all setups and waveforms saved in nonvolatile memory.

### Using the Disk Drive

This section describes how to use the disk drive. The File Utilities submenu is shown below.

SAVE/RECALL



Bottom	Side	Description
File Utilities	Delete	Deletes a file.
	Rename	Renames a file.
	Copy	Copies a file to another directory.
	Print	Prints a file to a printer connected to one of the hard copy ports.
	Create Directory	Creates a new directory.
	Confirm Delete	Turns On or Off a confirmation message before files are deleted.
	Overwrite Lock	Sets file overwrite protection to On or Off.
	Format	Formats a disk (erases all files).

## Key Points

**Upgrading Firmware.** You can use the disk drive to upgrade the oscilloscope firmware or install new application packages. See the documentation provided with these packages for instructions.

**Saved Waveform Formats.** Use the Internal waveform format to save a waveform to disk if you intend to recall it to the display later as a reference waveform. Use the Spreadsheet format to create a comma-separated data file compatible with most spreadsheet programs. Use the Mathcad format if you intend to import the waveform data into Mathcad software.

**Navigating the File System.** When you insert an IBM-formatted disk and push the File Utilities screen button, the oscilloscope shows a list of directories and files on the disk.

Use the general purpose knob to select a directory or file. To change the working directory, select the directory and then push the SELECT button. To move up one directory level, select .. and then push the SELECT button.

**Automatic File Numbering.** The oscilloscope gives all files created by the oscilloscope the default name TEK?????, where the question marks are placeholders for an automatic number sequence from 00000 to 99999.

You can change the TEK????? file to a new name with up to eight characters. If you use fewer than eight characters and include trailing question marks, the oscilloscope numbers the files sequentially if more than one are saved with the same base name.

For example, if you rename the TEK?????.ISF file to TEST?.ISF for a series of saved waveforms, the oscilloscope saves the first one as TEST00.ISF, the second one as TEST01.ISF, up to the last one as TEST99.ISF.

### Editing File, Directory, Reference Waveform, or Instrument Setup Names.

You can edit file names, directory names, reference waveform and instrument setup labels, and Ethernet parameters (TDS3EM only). Use the general purpose knob to select an alphanumeric character. Use the screen buttons described below to edit and enter the new name.

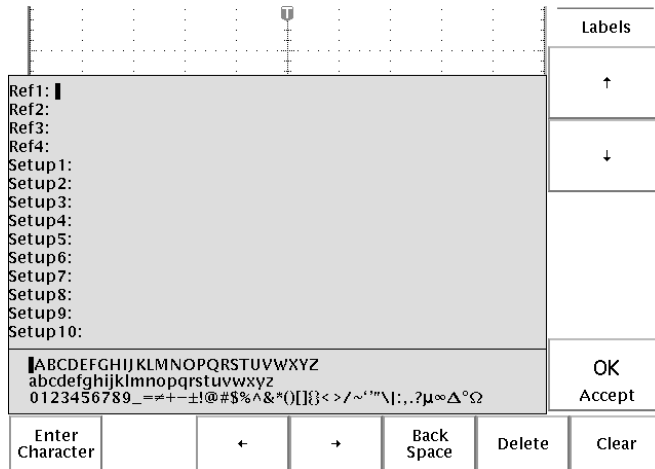

Screen button	Function
Enter Char	Enters the selected character into the field.
← and →	Moves the cursor to a different character in the field.
Back Space	Deletes the character before the cursor location.
Delete	Deletes the character at the cursor location.
Clear	Erases the current field value.
↑ and ↓	Selects the field that you want to edit.
OK Accept	Applies all field values.
MENU OFF	Exits the menu without applying field values.

**Deleting Files.** To delete a file, select the file with the general purpose knob, push the Delete screen button, and then push the OK Delete screen button when you see the confirmation screen.

If you do not want to see a confirmation screen each time you delete a file, push the Confirm Delete screen button to set it to Off.

**Renaming Files.** To rename a file, select the file with the general purpose knob, push the Rename screen button, and then follow the instructions on page 3–45.

Once a directory is created, you cannot rename it. However, you can delete the directory and create a new one with a new name.

**Copying Files and Directories.** To copy a file or directory, select the file or directory with the general purpose knob and push the Copy screen button. Now use the general purpose knob and SELECT button to select a destination directory. Push the copy confirmation screen button to complete the operation.

**Printing Files.** You can print files through any installed printer port to your printer. This function is especially useful if you want to print hard copy files that you have stored on a disk.

To print a file, select the file with the general purpose knob. Push the Print screen button and then select the port to which your printer is connected. Make sure that the oscilloscope is set to send the correct file format to your printer.

**Creating a Directory.** To create a directory, use the general purpose knob and SELECT button to select the working directory where you want the new directory to reside. Push the Create Directory screen button and then follow the instructions on page 3–45.

**Formatting a Disk.** The oscilloscope can format 1.44 MB IBM-compatible disks. To format a disk, insert it into the disk drive. Push the Format screen button and then push the OK Confirm Format screen button to confirm the operation. If you decide not to format the disk, push the MENU OFF button to stop the format operation.



---

**CAUTION.** *To avoid loss of data, do not format disks that already contain important data. When you format a disk, all files and directories will be erased and can never be recovered.*

---

**Setting Protections.** The oscilloscope provides two protections to help you prevent accidental loss of data:

- Confirm Delete shows a confirmation message each time you try to delete a file. You can turn Confirm Delete off if you do not want to see the message.
- Overwrite Lock prevents the oscilloscope from writing over existing files. You can turn Overwrite Lock off if you want to be able to write over existing files.

**File Extensions.** Files written by the oscilloscope have the following extensions. The oscilloscope can only read files with the SET, MSK, and ISF extensions.

File extension	File type
*.SET	Saved setup file
*.ISF	Saved waveform file, Internal format
*.CSV	Saved waveform file, Spreadsheet format
*.DAT	Saved waveform file, Mathcad format
*.TJ	Hard copy file, Thinkjet format
*.DJ	Hard copy file, Deskjet format
*.LJ	Hard copy file, Laserjet format
*.IBM	Hard copy file, Epson format
*.IMG	Hard copy file, Interleaf format
*.TIF	Hard copy file, TIFF format
*.RLE	Hard copy file, RLE format
*.PCX	Hard copy file, PCX format
*.BMP	Hard copy file, BMP format
*.EPS	Hard copy file, EPS format
*.BJC	Hard copy file, Bubble Jet format
*.DPU	Hard copy file, Seiko DPU-3445 format
*.GZ	Gnuzip-compressed hard copy file
*.MSK	Mask geometry file (requires TDS3TMT module)



## Trigger Controls

**MENU**

Push the trigger MENU button to show the trigger menu and then push the Type screen button to select Edge or Video. See pages 3–55 and 3–59 for descriptions of Edge and Video trigger.

See the manual for the TDS3TRG Advanced Trigger or TDS3VID Extended Video application module for more information if either module is installed.



### Trigger Level

Use the trigger LEVEL control to adjust the trigger level. When you change the trigger level, a horizontal line temporarily appears to show you the level on screen. After the line disappears, the trigger level is marked with a small arrow.

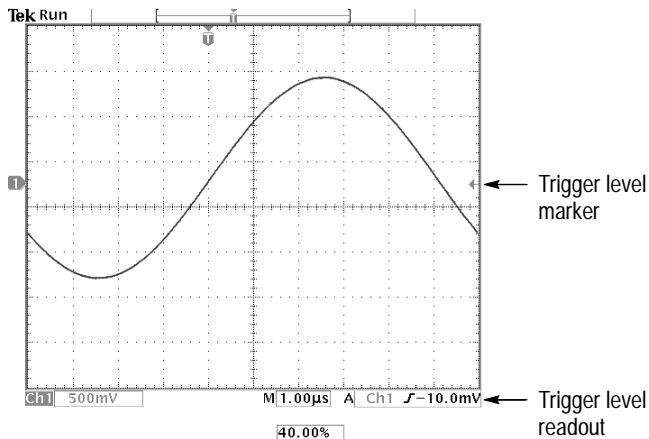

**SET TO  
50%**

### Set to 50%

Push the SET TO 50% button to set the trigger level to the 50% amplitude level of the trigger source waveform.

**FORCE  
TRIG**

### Force Trigger

Push the FORCE TRIG button to force an immediate trigger event, even in the absence of a signal. This function is useful in these situations:

- If you do not see a waveform on the screen when using Normal trigger mode, push FORCE TRIG to acquire the signal baseline to verify that it is on the screen.
- After you push the SINGLE SEQ button to set up for a single shot acquisition, you can push the FORCE TRIG button to do a practice acquisition to verify the control settings.

**B TRIG**

### B Trigger

To use the B trigger, the A trigger type must be Edge. Push the trigger MENU and B TRIG buttons to show the B-trigger menu and to activate triggering using both the A and B triggers. The light next to the B TRIG button indicates B trigger is active. Push the B TRIG button again to return to the single A trigger.

Bottom	Side	Description
B Trigger After A	B Trigger After A Time	Sets the oscilloscope to trigger on the next B-trigger event that occurs after a specified period of time from the A trigger. Use the general purpose knob to set the time value.
	Set to Delay Time (B→▼) then Set (B→▼) to 0s	Sets the B Trigger After A Time value to the horizontal B→▼ value, then sets B→▼ to zero seconds. B→▼ is the delay time from the B trigger point to the expansion point (center screen).
	Set to Min	Sets B Trigger After A time to 26.4 ns.
	B Events	Sets the oscilloscope to trigger on the <i>n</i> th B-trigger event after the A trigger. Use the general purpose knob to set the event value.
	Set to Min	Sets the B events count to 1.
Source		Sets Source, coupling, slope, and level for the B trigger. These settings are independent of similar settings for the A trigger. See page 3–55 for descriptions of these menu items.
Coupling		
Slope		
Level		

The trigger wait time is the minimum time between the A and B triggers. The trigger wait time is not the same as the horizontal delay time. You can use the horizontal delay function to delay acquisition relative to any trigger event, whether it is from the A trigger alone or from a trigger setup that involves both the A and B triggers.

The following figures show wait-for-time and wait-for-events triggering and how they relate to the horizontal delay time.

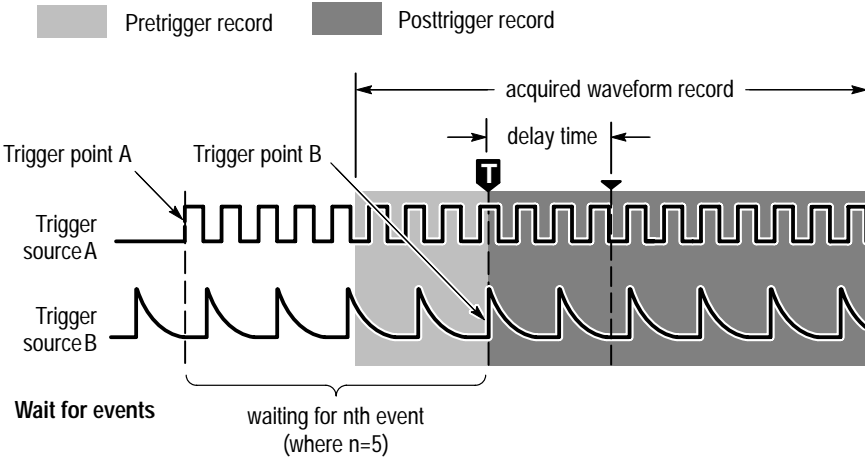
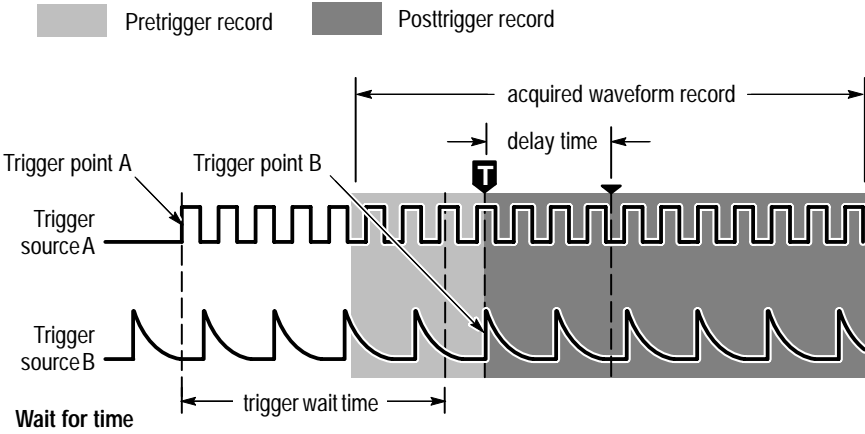

After the A trigger event is recognized, the oscilloscope begins counting B trigger events. However, for the first B event to be counted, that event must consist of both an opposite-polarity edge and the edge that is counted. The opposite-polarity edge must occur  $\geq 5$  ns after the A trigger arming event. If this condition is not met, the oscilloscope does not count the first event, which results in a trigger on the  $n+1^{\text{st}}$  event. Refer to the following figure, where  $n=3$  and A and B trigger slopes are set to rising edge.

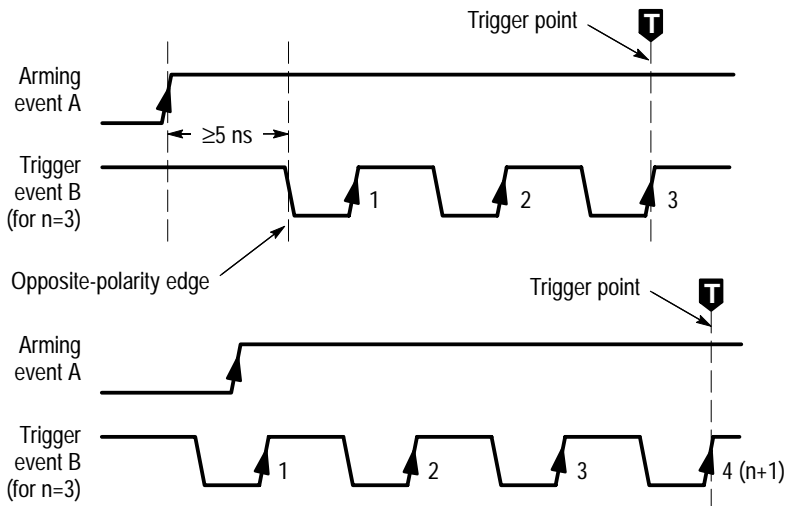

### Trigger Status

Readout at the top of the screen shows you the current trigger status. The table below explains the trigger status indicators.

Trigger status	Explanation
Auto	The oscilloscope is acquiring using auto trigger. Valid trigger events, if any, are infrequent.
Trig'd	The oscilloscope is acquiring using valid trigger events that are frequent enough to avoid auto triggering.
PrTrig	The oscilloscope is acquiring the pretrigger part of the waveforms. This status is shown only at the slowest time/division settings.
Trig?	The oscilloscope has acquired the pretrigger part of the waveforms and is waiting for a valid trigger event.
BTrig?	The A trigger event has occurred. The oscilloscope is armed and waiting for a valid B trigger event.

## Edge Trigger

Use Edge triggering to trigger on the rising or falling edge of the input signal at the trigger threshold.

MENU

Bottom	Side	Description
Type Edge		
Source	Ch1 ... Ch4	Sets the trigger source to a specific channel.
	AC Line	Sets the trigger source to use the AC line signal (not available when operating with batteries).
	Ext	Selects the external trigger source in two-channel oscilloscopes. Ext/10 provides a larger trigger-level range at reduced sensitivity.
	Ext/10	
	Vert	Sets the trigger source to the lowest-numbered active channel in the display.
Coupling	DC	Selects DC coupling.
	HF Reject	Rejects frequencies above 30 kHz in the trigger signal.
	LF Reject	Rejects frequencies below 1 kHz in the trigger signal.
	Noise Reject	DC coupling with low sensitivity to reject noise in the trigger signal.
Slope	/ (rising edge)	Triggers on the rising edge of a signal.
	\ (falling edge)	Triggers on the falling edge of a signal.

Bottom	Side	Description
Level	Level	Use to set the trigger level with the general purpose knob.
	Set to TTL	Sets the trigger level to +1.4 V for TTL logic.
	Set to ECL	Sets the trigger level to -1.3 V for ECL logic ( $V_{ee} = -5.2$ V).
	Set to 50%	Sets the trigger level to the 50% amplitude level of the signal.
Mode & Holdoff	Auto (untriggered roll)	Enables free-running and roll-mode acquisitions.
	Normal	Triggers only on valid trigger events.
	Holdoff (time)	Sets holdoff to a specific time.
	Holdoff (% of record)	Sets holdoff to a percent of the record duration.
	Set to Min	Sets holdoff to the minimum value.

### Key Points

**Displaying the Trigger Source.** You do not have to display a channel to use it as a trigger source.



**Normal and Auto Mode.** Use Normal trigger mode when you want to trigger only on a valid event. Use Auto trigger mode when you want the acquisition to occur, even when there is not a valid trigger event. Also choose Auto when you want a rolling waveform, with no trigger, at the slower time base settings. See page 3–32 for more information about roll mode.

**External Trigger.** Two-channel oscilloscopes have an external trigger input. The trigger level range for the EXT setting is  $-0.8\text{ V}$  to  $+0.8\text{ V}$ . The trigger level range for the EXT/10 setting is  $-8\text{ V}$  to  $+8\text{ V}$ .

For best external trigger performance, apply a square-wave signal with amplitude greater than the specified minimum level range and with well-defined transitions.

Four-channel oscilloscopes do not have a separate external trigger input; however, you can use any of the four channels as your trigger source.

**Holdoff.** You can use holdoff to help stabilize the display of complex waveforms. After you press the Mode & Holdoff screen button, use the general purpose knob to set the holdoff time as an absolute value or as a percent of the record duration.

Holdoff begins when the oscilloscope recognizes a trigger event and disables the trigger system until acquisition is complete. The trigger system remains disabled during the holdoff time.

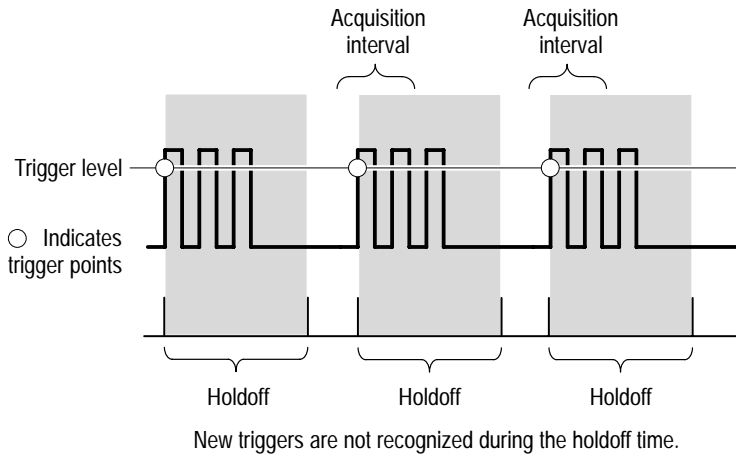

---

**NOTE.** For best results, choose Normal trigger mode when using long holdoff settings (10 ms or greater).

---

## Video Trigger

Choose video triggering to trigger on the odd fields, even fields, or on all the lines of an NTSC, PAL, or SECAM video signal. See the manual for the TDS3VID Extended Video application module for more information if that module is installed.

MENU

Bottom	Side	Description
Type Video		
Standard	525/NTSC	Triggers on a NTSC signal.
	625/PAL	Triggers on a PAL signal.
	SECAM	Triggers on a SECAM signal.
Source		See page 3–55 for descriptions of these menu items.
Trigger On	Odd	Triggers on odd or even fields in an interlaced signal.
	Even	
	All Fields	Triggers on any field in an interlaced or noninterlaced signal.
	All Lines	Triggers on all lines.
Mode & Holdoff		See page 3–56 for descriptions of these menu items.

## Key Points

**Displaying the Trigger Source.** You do not have to display a channel to use it as a trigger source.

**Sync Pulses.** When you choose Video, the trigger always occurs on negative-going sync pulses. If your video signal has positive-going sync pulses, invert the signal using the Vertical menu. See page 3–71 for information about inverting a signal.

### Utility

The following are examples of what you can do with each of the six branches in the Utility menu:

- Use Config to select a language or set the time and date.
- Use Apps if an installed application module places items in this menu. See the documentation provided with your application packages for more information.
- Use I/O to set up the communication ports.
- Use Hard Copy to set up hard copy parameters. Refer to *Hard Copy* on page 3–21 for information about setting up and printing a hard copy.
- Use Cal to compensate the signal path.
- Use Diags to run internal diagnostic routines.

Push the UTILITY button to show the utility menu. Then, push the System screen button to choose the branch. The remaining items in the utility menu change depending on the branch you choose.

## Configure System

Use the System Config branch to access these functions.



Bottom	Side	Description
System Config		
Language	English	Use to choose your native language. Most on-screen text appears in the language you choose.
	Français	
	Deutsch	
	Italiano	
	Español	
	Português	
	(Russian)	
	(Japanese)	
	(Korean)	
	(Simplified Chinese)	
(Traditional Chinese)		
Set Date & Time	Display Date/Time	Use to turn the date/time display On or Off.
	Hour Min	Use to set the internal clock with the current hour and minute.
	Month Day	Use to set the internal clock with the current month and day.
	Year	Use to set the internal clock with the current year.
	OK Enter Date/Time	Sets the date and time of the internal clock.

Bottom	Side	Description
Battery Time-Outs	Power Off Time-Out	Use to set the time before an automatic shut down.
	Backlight Time-Out	Use to set the time before the backlight automatically turns off.
Tek Secure Erase Memory		Erases all nonvolatile waveform and setup memory.
Version		Use to see the firmware version.

### Key Points

**Setting the Date and Time.** To set the internal clock with the current date and time, push the Set Date & Time screen button. Use the general purpose knob to set the values after you push the screen buttons for the year, day and month, hour and minute. Push the OK Enter Date/Time screen button to complete the operation.

**Power Off Time-Out.** Use this feature to automatically turn the oscilloscope to standby if it is not being used. Use the general purpose knob to set the power off time-out delay to a fixed time or to ∞ (time-out off). Cycle the power switch to turn the oscilloscope back on after an automatic shut down.

Power off time-out operates only when you use battery power.

**Backlight Time-Out.** Press this button to adjust the backlight time-out delay. This feature automatically turns the backlight off after a period of time if the oscilloscope is not being used. Use the general purpose knob to set the backlight time-out delay to a fixed time or to  $\infty$  (time-out off). Push any button to turn the backlight back on after an automatic time-out.

Backlight time-out operates only when you use battery power.

**Tek Secure.** If you have acquired confidential data on your oscilloscope, you may want to execute the Tek Secure function before you return the oscilloscope to general use. The Tek Secure function does the following tasks:

- Replaces all waveforms in all reference memories with null sample values
- Replaces the current front-panel setup and all stored setups with the factory setup
- Calculates the checksums of all waveform memory and setup memory locations to verify successful completion of waveform and setup erasure
- Displays a confirmation or warning message if the checksum calculation is successful or unsuccessful

After you execute the Tek Secure function, you must turn off the oscilloscope power and then turn the power back on to complete the process.

### I/O System

Use the System I/O branch to access these functions.



Bottom	Side	Description
System I/O		
GPIB (TDS3GM only)	Talk/Listen Address	Sets the GPIB address.
	Hard Copy (Talk Only)	Sets the GPIB port to talk only for making hard copies.
	Off Bus	Disables the GPIB port.
	Debug	Enables and disables a message window to help you debug GPIB problems.
RS-232 (all communications modules)	Baud Rate	Sets the baud rate in steps from 1200 to 38400.
	Flagging	Use to enable hard flagging (RTS/CTS) or turn flagging off.
	EOL	Selects end-of-line terminator.
	Debug	Enables and disables a message window to help you debug RS-232 problems.
	Set RS-232 Parameters to Default Values	Sets baud rate = 9600, hard flagging = on, and EOL = LF.



Bottom	Side	Description
Ethernet Network Settings (TDS3EM only)	Change Instrument Settings	Displays a list of fields in which you set oscilloscope Ethernet parameters such as address, instrument name, domain name, and so on. Refer to the <i>TDS3000 Digital Phosphor Oscilloscope Programmer Manual</i> for procedures to set these fields. Refer to page 3–45 for an explanation of the field editing menu items.
	DHCP/BOOTP	
	Debug	
Ethernet Printer Settings (TDS3EM only)	Add Printer	Adds, renames, or deletes an Ethernet network printer from the oscilloscope printer list. Refer to the <i>TDS3000 Digital Phosphor Oscilloscope Programmer Manual</i> for procedures to set these fields. Refer to page 3–45 for an explanation of the field editing menu items.
	Rename Printer	
	Delete Printer	
	Confirm Delete	Enables or disables displaying a confirmation message before deleting a printer from the oscilloscope printer list.

### Key Points

**RS-232 Troubleshooting.** If you are having difficulties with RS-232 communication, try the following remedies:

- Verify that you are using the correct RS-232 cable and adapters. Most computers require a null-modem connection to the oscilloscope. Most printers require a straight-through connection to the oscilloscope.
- Verify that the RS-232 cable is connected to the correct port on your computer or hard copy device.
- Reset the RS-232 parameters to defaults and then set the baud rate to match the computer or hard copy device. The default settings (except baud rate) are standard on most computers and hard copy devices.
- Enable the debug window to see the RS-232 status, errors, data transmitted, and data received.

Refer to the *TDS3000-Series Programmer Manual* for more information about using the RS-232 port.

**GPIB Guidelines.** Follow these guidelines when you connect your oscilloscope to a GPIB network:

- Turn off the oscilloscope and all external devices before connecting the oscilloscope to the GPIB network.
- Assign a unique device address to the oscilloscope. Two devices cannot share the same device address.
- Turn on at least two-thirds of the GPIB devices while using the network.

Refer to the *TDS3000-Series Programmer Manual* for more information about using the GPIB port.

**Ethernet Guidelines.** Refer to the *TDS3000-Series Programmer Manual* for Ethernet setup and troubleshooting guidelines.

## Calibration System

Use the System Cal branch to access these functions.



Bottom	Side	Description
System Cal		
Signal Path		Compensates the signal paths to obtain best measurement accuracy.
Factory Cal		Used to calibrate the oscilloscope. This is a service function only.
Cal Due Control	Notify After Hours of Operation	Sets the number of hours of operation before notifying you that a calibration is due.
	Notify After Years of Elapsed Time	Sets the number of years before notifying you that a calibration is due.

### Key Points

**Signal Path Compensation.** For maximum accuracy at any time, run the signal path compensation routine just before taking critical measurements. To meet accuracy specifications, run the routine if the ambient temperature changes by 10° C or more.

Before running the routine, disconnect any probes or cables from the channel inputs. Then, push the Signal Path and OK Compensate Signal Path screen buttons to confirm that you are ready to proceed. The routine takes several minutes to complete.

**Factory Cal.** Service personnel use these functions to calibrate the oscilloscope internal voltage references using external sources. Refer to your Tektronix field office or representative for assistance with these processes.

**Cal Due Control.** The calibration due notification occurs only in the power-on screen. Set the controls to  $\infty$  if you do not want to be notified when calibration is due.

**Diagnostic System**

Use the System Diag branch to access these functions.



Bottom	Side	Description
System Diags		
Execute		Starts diagnostics.
Loop	Once	Executes the diagnostic loop once.
	Always	Executes the diagnostic loop continuously.
	Until Fail	Executes until a failure occurs.
Error Log	Page Up	Use to see the previous error log page.
	Page Down	Use to see the next error log page.

**Key Points**

**Starting Diagnostics.** To execute the built-in diagnostic routines, disconnect all cables or probes from the oscilloscope inputs, and then push the OK Run Test screen button.

**Stopping Diagnostics.** Choose how you want the diagnostic routines to execute:

- Loop Once runs all diagnostic routines one time and then stops.
- Loop Always runs the diagnostic routines continuously. Push the RUN/STOP and then the MENU OFF buttons to resume normal operation.
- Loop Until Fail runs the diagnostic routines until the oscilloscope fails a test or until you cycle the power.

**Error Log.** The error log contains summary data gathered over the life of the oscilloscope. The error log lists the last 100 errors encountered. The last error in the list is the most recent.

Under normal circumstances, the error log should be empty. Any entry in the error log may indicate a hardware failure or firmware fault. If you can repeatedly cause an entry to be added to the error log, please contact a Tektronix service representative for assistance.

## Vertical Controls

You can use the vertical controls to select waveforms, adjust the waveform vertical position and scale, and set input parameters. All vertical operations affect the selected waveform. Push a channel button (CH 1, CH 2, CH 3, or CH 4), the MATH button, or the REF button to select a waveform.



### Vertical Position Control

Use the vertical POSITION control to locate the selected waveform in the display. When you change the vertical position, a horizontal line temporarily appears to show you the ground reference level on the screen. After the line disappears, the ground reference level is marked at the left of the graticule.

If acquisition is stopped you can still reposition waveforms for analysis. The new position setting is used when acquisition resumes.



### Waveform Off

Push the waveform OFF button to remove the selected waveform from the display. You can still use the channel as a trigger source.



### Vertical Scale Control

Use the vertical SCALE control to set the vertical scale factor of the selected waveform in 1-2-5 increments. If acquisition is stopped you can still rescale waveforms for analysis. The new scale setting is used when acquisition resumes.

You can also make fine adjustments to the vertical scale. See *Channel Buttons* on page 3-71 for more information.

**MENU****Vertical Menu**

Push the vertical MENU button to show the vertical menu of the selected waveform. See these pages for more information about the specific vertical menus:

- *Channel Buttons* below
- *Math Button* on page 3–74
- *Ref Button* on page 3–76

**CH 1****Channel Buttons**

Push a channel button (CH 1, CH 2, CH 3, or CH 4) to select a channel. Each channel button also displays the channel if it is not already displayed. Push the vertical MENU button to show the vertical menu of the selected channel. All vertical operations below affect only the selected waveform.

Bottom	Side	Description
Coupling	DC	Sets input coupling to DC.
	AC	Sets input coupling to AC.
	GND	Provides a 0 V signal reference. The preamplifier disconnects from the input BNC. Input termination remains connected to the input BNC.
	$\Omega$	Sets input resistance to 50 $\Omega$ or 1 M $\Omega$ , for DC or AC coupling.
Invert	Invert Off	Use for normal operation.
	Invert On	Inverts the polarity of the signal in the preamplifier.

Bottom	Side	Description
Bandwidth	Full Bandwidth	Sets bandwidth to the full oscilloscope bandwidth.
	150 MHz	Sets the bandwidth to 150 MHz (not available on some models).
	20 MHz	Sets the bandwidth to 20 MHz.
Fine Scale	Fine Scale	Enables fine scale adjustment with the general purpose knob.
Position	Vertical Position	Enables numerical vertical position adjustment.
	Set to 0 divs	Sets vertical position to center screen.
Offset	Vertical Offset	Enables vertical offset adjustment with the general purpose knob.
	Set to 0 V	Sets vertical offset to 0 V.
Probe Setup	Voltage Probe	Use to set probe gain or attenuation for probes that do not have the TekProbe II interface.
	Current Probe	
	Deskew	Use to adjust the time skew correction for each probe.
	Set to 0	Use to set probe skew correction to zero.

### Key Points

**Using Probes with the TekProbe II Interface.** When you attach a probe with the TekProbe II interface, the oscilloscope sets the channel sensitivity, coupling, and termination resistance automatically to match the probe requirements.



**Vertical Preview.** When you change the vertical POSITION or SCALE controls while the acquisition is stopped or it is waiting for the next trigger, the oscilloscope rescales and repositions the selected waveform in response to the new vertical control settings. You may see a clipped waveform if the original acquisition went off the screen. The oscilloscope then uses the new settings for the next acquisition.

In contrast to horizontal preview, the math waveform, cursors, and automatic measurements remain active and valid when using vertical preview.

**The Difference Between Vertical Position and Offset.** Vertical position is a display function. Adjust the vertical position to place the waveforms where you want to see them. The waveform baseline locations track adjustments made to their positions.

When you adjust vertical offset you see a similar effect, but it is actually quite different. Vertical offset is applied before the oscilloscope preamplifier and can be used to increase the effective dynamic range of the inputs. For example, you can use vertical offset to look at small variations in a large DC voltage. Set the vertical offset to match the nominal DC voltage and the signal appears in the center of the screen.

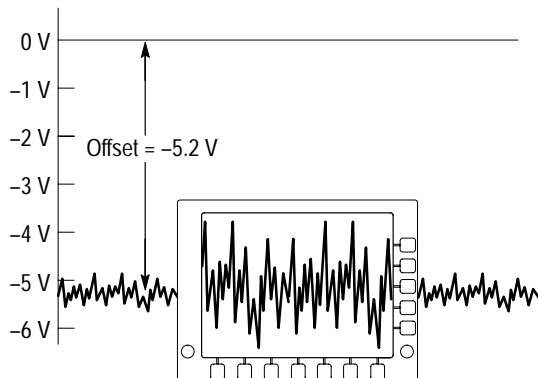

**50 Ω Protection.** If you select the 50 Ω termination resistance, the maximum vertical scale factor is limited to 1 V/div. If you apply excessive input voltage, the oscilloscope automatically switches to 1 MΩ termination resistance to protect the internal 50 Ω termination.

**MATH**

**Math Button**

Push the MATH button to define the math waveform using the math menu. Also push the MATH button to display or select the math waveform. See the *TDS3FFT FFT Application Module User Manual* if you have that application module installed.

Bottom	Side	Description
Dual Wfm Math	Set 1st Source to	Selects the first source waveform.
	Set Operator to	Selects the math operator: +, -, ×, or ÷
	Set 2nd Source to	Selects the second source waveform.

**Key Points**

**Dual-Waveform Math.** For the dual-waveform math operations, the two source waveforms interact with the math operators in the sequence shown below.

Operation	Expression of math waveform
+	Source 1 + Source 2
-	Source 1 – Source 2
×	Source 1 × Source 2
÷	Source 1 ÷ Source 2

**Scaling and Positioning the Math Waveform** To position or scale a math waveform, select the math waveform and then adjust it with a vertical POSITION or SCALE control. You can do this whether acquisition is running or is stopped.

**Math Interaction with Preview.** If you select a channel waveform and then adjust the vertical POSITION or SCALE control while the acquisition is stopped, the math waveform remains fixed. It does not track the changes you see to the channel waveform. The same is true if you adjust the horizontal POSITION or SCALE control under these conditions.

**Gray-Scale Restriction.** Math waveforms are always based on the most current acquisitions and do not contain any gray-scale information.

**Source Waveform Screen Position.** When displaying dual-waveform math waveforms, make sure that the source waveforms do not extend beyond the top or bottom edge of the screen. If part of the source waveform is positioned outside the screen, the math waveform may not display correctly.

REF

**Ref Button**

Push the REF button to show the reference menu. Push one of the submenus to display a reference waveform or make it the selected reference waveform.

Bottom	Side	Description
Ref 1	Save Ch1 to Ref1	Saves channel 1 to Ref 1.
	Save Ch2 to Ref1	Saves channel 2 to Ref 1.
	Save Ch3 to Ref1	Saves channel 3 to Ref 1.
	Save Ch4 to Ref1	Saves channel 4 to Ref 1.
	Save Math to Ref1	Saves the math waveform to Ref 1.
Ref 2 Ref 3 Ref 4	Identical settings for the reference waveforms Ref 2, Ref 3, and Ref 4.	

**Key Points**

**Selecting and Displaying Reference Waveforms.** You can display all four reference waveforms at the same time. Push the submenu button to select a particular reference waveform. The selected waveform appears brighter than other displayed reference waveforms.

**Removing Reference Waveforms from the Display.** To remove a reference waveform from the display, select that reference waveform and then push the waveform OFF button .

**Scaling and Positioning a Reference Waveform** You can position and scale a reference waveform independently from all other displayed waveforms. Select the reference waveform and then adjust it with a vertical or horizontal POSITION or SCALE control. You can do this whether acquisition is running or is stopped.

If a reference waveform is selected, scaling and repositioning of the reference waveform operates the same way whether zoom is turned on or off.

**Gray-Scale Restriction.** Reference waveforms are always saved from the most current acquisition and do not contain any gray-scale information.





# Appendices





# Appendix A: Specifications

This appendix contains specifications for the TDS3000 Series oscilloscopes. All specifications are guaranteed unless noted as “typical.” Typical specifications are provided for your convenience but are not guaranteed. Specifications that are marked with the ✓ symbol are checked in *Appendix E: Performance Verification*.

All specifications apply to all TDS3000 models unless noted otherwise. To meet specifications, two conditions must first be met:

- The oscilloscope must have been operating continuously for ten minutes within the operating temperature range specified.
- You must perform the Compensate Signal Path operation described on page 1–4. If the operating temperature changes by more than 10° C, you must perform the Compensate Signal Path operation again.

## Specifications

Acquisition		
Acquisition modes	Sample (Normal), Peak detect, Envelope, and Average	
Single Sequence	<i>Acquisition mode</i>	<i>Acquisition stops after</i>
	Sample, Peak Detect	One acquisition, all channels simultaneously
	Average, Envelope	N acquisitions, all channels simultaneously, N is settable from 2 to 256 (or ∞ for Envelope)

**Specifications (Cont.)**

<b>Inputs</b>				
Input coupling	DC, AC, or GND Channel input remains terminated when using GND coupling.			
Input impedance, DC coupled	1 M $\Omega$ $\pm$ 1% in parallel with 13 pF $\pm$ 2 pF, TekProbe compatible 50 $\Omega$ $\pm$ 1%; VSWR $\leq$ 1.5:1 from DC to 500 MHz, typical			
Maximum voltage at input BNC (1 M $\Omega$ )	<i>Overvoltage category</i>	<i>Maximum voltage</i>		
	CAT I Environment (refer to page A-12)	150 V <sub>RMS</sub> (400 V <sub>pk</sub> )		
	CAT II Environment (refer to page A-12)	100 V <sub>RMS</sub> (400 V <sub>pk</sub> )		
	For steady-state sinusoidal waveforms, derate at 20 dB/decade above 200 kHz to 13 V <sub>pk</sub> at 3 MHz and above.			
Maximum voltage at input BNC (50 $\Omega$ )	5 V <sub>RMS</sub> with peaks $\leq$ $\pm$ 30 V			
Maximum floating voltage	0 V from chassis (BNC) ground to earth ground, or 30 V <sub>RMS</sub> (42 V <sub>pk</sub> ) only under these conditions: no signal voltages >30 V <sub>RMS</sub> (>42 V <sub>pk</sub> ), all common leads connected to the same voltage, no grounded peripherals attached			
Channel-to-channel crosstalk, typical	Measured on one channel, with test signal applied to another channel, and with the same scale and coupling settings on each channel			
	<i>Frequency range</i>	<i>TDS3012 TDS3014</i>	<i>TDS3032 TDS3034</i>	<i>TDS3052 TDS3054</i>
	$\leq$ 100 MHz	$\geq$ 100:1	$\geq$ 100:1	$\geq$ 100:1
	$\leq$ 300 MHz	—	$\geq$ 50:1	$\geq$ 50:1
	$\leq$ 500 MHz	—	—	$\geq$ 30:1
Differential delay, typical	100 ps between any two channels with the same scale and coupling settings			

## Specifications (Cont.)

Vertical				
Number of channels	<i>TDS3012, TDS3032, TDS3052</i>		<i>TDS3014, TDS3034, TDS3054</i>	
	2 plus external trigger input		4	
Digitizers	9-bit resolution, separate digitizers for each channel sample simultaneously			
SCALE Range (at BNC)	1 M $\Omega$		50 $\Omega$	
	1 mV/div to 10 V/div		1mV/div to 1 V/div	
Fine SCALE	Adjustable with $\geq 1\%$ resolution			
Polarity	Normal and Invert			
Position range	$\pm 5$ divisions			
✓ Analog bandwidth, 50 $\Omega$ (also typical at 1 M $\Omega$ with standard probe)	Bandwidth limit set to Full, operating ambient $\leq 30$ °C, derate 1%/°C above 30 °C			
	<i>Scale range</i>	<i>TDS3012 TDS3014</i>	<i>TDS3032 TDS3034</i>	<i>TDS3052 TDS3054</i>
	5 mV/div to 1 V/div	100 MHz	300 MHz	500 MHz
	2 mV/div to 4.98 mV/div	100 MHz	250 MHz	300 MHz
	1 mV/div to 1.99 mV/div	90 MHz	150 MHz	175 MHz
Calculated rise time, typical	—	3.5 ns	1.2 ns	0.7 ns
Analog bandwidth limit, typical	Selectable between 20 MHz, 150 MHz (not available on TDS3012 or TDS3014), or Full			
Lower frequency limit, AC coupled, typical	7 Hz for 1 M $\Omega$ , reduced by a factor of ten when using a 10X passive probe; 140 kHz for 50 $\Omega$			

**Specifications (Cont.)**

<b>Vertical</b>			
Peak detect or Envelope pulse response, typical	Minimum width of pulse with amplitude of $\geq 2$ div to capture 50% or greater amplitude		
	<i>Sample rates <math>\leq 125</math> MS/s</i>	<i>Sample rates <math>\geq 250</math> MS/s</i>	
	1 ns	1/sample rate	
DC gain accuracy	$\pm 2\%$ , derated at $0.07\%/^{\circ}\text{C}$ for temperatures below $+18^{\circ}\text{C}$ and above $+28^{\circ}\text{C}$ , in Sample or Average acquisition mode		
DC measurement accuracy	<i>Measurement type</i>	<i>DC Accuracy (in volts)</i>	
	Sample acquisition mode, typical	Absolute measurement of any waveform point, and High, Low, Max, and Min measurements.	$\pm [0.02^1 \times   \text{reading} - (\text{offset} - \text{position})   + \text{offset accuracy} + 0.15 \text{ div} + 0.6 \text{ mV}]$
		Delta voltage between any two points on a waveform, and all other automatic measurements.	$\pm [0.02^1 \times   \text{reading}   + 0.15 \text{ div} + 1.2 \text{ mV}]$
	✓ Average acquisition mode ( $\geq 16$ averages)	Absolute measurement of any waveform point, and High, Low, Max, and Min measurements.	$\pm [0.02^1 \times   \text{reading} - (\text{offset} - \text{position})   + \text{offset accuracy} + 0.1 \text{ div}]$
		Delta voltage between two points on a waveform, and all other automatic measurements.	$\pm [0.02^1 \times   \text{reading}   + 0.05 \text{ div}]$
Offset range	<i>Scale range</i>	<i>Offset range</i>	
	1 mV/div to 9.95 mV/div	$\pm 100 \text{ mV}$	
	10 mV/div to 99.5 mV/div	$\pm 1 \text{ V}$	
	100 mV/div to 995 mV/div	$\pm 10 \text{ V}$	
	1 V/div to 10 V/div	$\pm 100 \text{ V}$	
Offset accuracy	$\pm (0.005 \times   \text{offset} - \text{position}   + 0.1 \text{ div})$		

**1 0.02 term (gain component) derated at  $0.00025/^{\circ}\text{C}$  above  $30^{\circ}\text{C}$**

## Specifications (Cont.)

<b>Horizontal</b>				
Acquisition (horizontal) resolution	<i>Normal</i>		<i>Fast trigger</i>	
Record length	10,000 points		500 points	
Acquisition rate, maximum	Up to 450 waveforms/s		Up to 3,000 waveforms/s	
Sample rate range	<i>Acquisition resolution</i>	<i>TDS3012</i> <i>TDS3014</i>	<i>TDS3032</i> <i>TDS3034</i>	<i>TDS3052</i> <i>TDS3054</i>
	Normal	100 S/s to 1 GS/s	100 S/s to 2.5 GS/s	100 S/s to 5 GS/s
	Fast trigger	5 S/s to 1.25 GS/s	5 S/s to 2.5 GS/s	5 S/s to 5 GS/s
Seconds/division range	—	4 ns/div to 10 s/div	2 ns/div to 10 s/div	1 ns/div to 10 s/div
✓ Sample rate and delay time accuracy	±200 ppm over any ≥1 ms time interval			
<b>Trigger</b>				
External trigger input, typical	1 MΩ in parallel with 17 pF, TekProbe compatible (TDS3012, TDS3032, TDS3052 only)			
External trigger maximum voltage	<i>Overtolerance category</i>		<i>Maximum voltage</i>	
	CAT I Environment (refer to page A-12)		150 V <sub>RMS</sub> (400 V <sub>pk</sub> )	
	CAT II Environment (refer to page A-12)		100 V <sub>RMS</sub> (400 V <sub>pk</sub> )	
For steady-state sinusoidal waveforms, derate at 20 dB/decade above 200 kHz to 13 V <sub>pk</sub> at 3 MHz and above.				
External trigger maximum floating voltage	0 V from chassis (BNC) ground to earth ground, or 30 V <sub>RMS</sub> (42 V <sub>pk</sub> ) only under these conditions: no signal voltages >30 V <sub>RMS</sub> (>42 V <sub>pk</sub> ), all common leads connected to the same voltage, no grounded peripherals attached			

**Specifications (Cont.)**

<b>Trigger</b>		
	<i>Source</i>	<i>Sensitivity</i>
✓ Edge trigger sensitivity	Any channel, DC coupled	0.35 div from DC to 50 MHz, increasing to 1 div at oscilloscope bandwidth
Edge trigger sensitivity, typical	External trigger	100 mV from DC to 50 MHz, increasing to 500 mV at 300 MHz
	External/10 trigger	500 mV from DC to 50 MHz, increasing to 3 V at 300 MHz
	Any channel, NOISE REJ coupled	3.5 times the DC-coupled limits
	Any channel, HF REJ coupled	1.5 times the DC-coupled limit from DC to 30 kHz, attenuates signals above 30 kHz
	Any channel, LF REJ coupled	1.5 times the DC-coupled limits for frequencies above 80 kHz, attenuates signals below 80 kHz
Trigger level range	<i>Source</i>	<i>Sensitivity</i>
	Any channel	±8 divisions from center of screen, ±8 divisions from 0 V if LF REJ trigger coupled
	External external	±800 mV
	External/10 trigger	±8 V
	Line	Fixed at the midlevel of the AC line
SET LEVEL TO 50%, typical	Operates with input signals ≥45 Hz	

## Specifications (Cont.)

<b>Trigger</b>		
Trigger level accuracy, typical	<i>Source</i>	<i>Sensitivity</i>
	Any channel	±0.2 divisions
	External trigger	±20 mV
	External/10 trigger	±200 mV
	Line	N/A
Trigger holdoff range	250.8 ns to 10 s	
Video trigger sensitivity, typical	Triggers on negative sync of NTSC, PAL, or SECAM signal	
	<i>Source</i>	<i>Sensitivity</i>
	Any channel	0.6 to 2.5 divisions of video sync tip
	External trigger	150 mV to 625 mV of video sync tip
	External/10 trigger	1.5 V to 6.25 V of video sync tip
B Trigger	<i>Trigger After Time</i>	<i>Trigger After B Events</i>
Range	13.2 ns to 50 s	1 event to 9,999,999 events
Minimum time between arm and trigger, typical	5ns from the end of the time period and the B trigger event	5 ns between the A trigger event and the first B trigger event
Minimum Pulse Width, typical	—	B event width, 2 ns
Maximum Frequency, typical	—	B event frequency, 250 MHz

**Specifications (Cont.)**

<b>Display</b>	
Display screen	6.5 in (165 mm) diagonal color liquid crystal
Display resolution	640 horizontal by 480 vertical pixels
Backlight intensity, typical	200 cd/m <sup>2</sup>
Display color	Up to 16 colors, fixed palette
External display filter	Scratch-resistant tempered glass
<b>I/O ports</b>	
Parallel printer port	Centronics compatible, DB-25 female connector
GPIB interface	Available as optional accessory TDS3GM
RS-232 interface	Available as optional accessory TDS3GM or TDS3VM, DB-9 male connector
VGA signal output	Available as optional accessory TDS3VM, DB-15 female connector, 31.6 kHz sync rate, EIA RS-343A compliant
Probe compensator output, typical	5.0 V into $\geq 1 \text{ M}\Omega$ load, frequency = 1 kHz
<b>Miscellaneous</b>	
Nonvolatile memory	Typical retention time $\geq 5$ years for front-panel settings, unlimited for saved waveforms and setups
Floppy disk	3.5 in, DOS format, 720 KB or 1.44 MB compatible
Internal clock	Provides date/time stamp for stored data and the current time and date to the front panel, if enabled. Year-2000 compliant.
Radiated immunity	Per methods of EN50082-1 and EN61000-4-3, the increase in trace noise is not to exceed four major divisions peak-to-peak. Ambient RF fields may induce triggering when trigger threshold is offset less than two major divisions from ground reference.



**Specifications (Cont.)**

<b>Power sources</b>	
AC line power	Operates the oscilloscope and charges the optional internal battery
Source voltage	90 V <sub>RMS</sub> to 250 V <sub>RMS</sub> , continuous range (CAT II)
Source frequency	47 Hz to 440 Hz
Power consumption	75 W maximum
Battery power	Optional accessory TDS3BAT, rechargeable NiCad battery pack
Operating time, typical	2 hours, depending on operating conditions
Battery charge time, typical	18 hours in the oscilloscope, 3 hours in the optional external charger TDS3CHG
Line fuse	Internal, not user replaceable
<b>Environmental</b>	
Temperature	Operating range (no disk installed): +5 °C to +50 °C Nonoperating range (no disk installed): -20 °C to +60 °C Typical operating range for floppy disks: +10 °C to +50 °C
Humidity	Operating range (no disk installed): 20% to 80% RH below 32 °C, derate upper limit to 21% RH at 50 °C Nonoperating range (no disk installed): 5% to 90% RH below 41 °C, derate upper limit to 30% RH at 60 °C Typical operating range for floppy disks: 20% to 80% RH below 32 °C, derate upper limit to 21% RH at 50 °C
Pollution Degree	Pollution Degree 2: Typical home or office environment.

**Specifications (Cont.)**

<b>Environmental</b>	
Altitude	Operating limit: 3000 m Nonoperating limit: 15,000 m
Random vibration	Operating: 0.31 g <sub>RMS</sub> from 5 Hz to 500 Hz, 10 minutes on each axis Nonoperating: 2.46 g <sub>RMS</sub> from 5 Hz to 500 Hz, 10 minutes on each axis
Drop resistance, typical	Survives a 152 mm (6 in) drop onto concrete with only cosmetic damage
<b>Mechanical</b>	
Size	Height: 176 mm (6.9 in), 229 mm (9.0 in) including handle Width: 375 mm (14.75 in) Depth: 149 mm (5.9 in)
Weight	Oscilloscope only: 3.2 kg (7.0 lbs) With accessories and carry case: 4.1 kg (9.0 lbs) When packaged for domestic shipment: 5.5 kg (12.0 lbs) Optional battery pack: 2 kg (4.5 lbs)

**Specifications (Cont.)**

<b>EMC certifications and compliances</b>	
EMC Compliance: European Union	Meets intent of Directive 89/336/EEC for Electromagnetic Compatibility. Compliance was demonstrated to the following specifications as listed in the Official Journal of the European Communities:  EN 55011                    Class A Radiated and Conducted Emissions EN 50082-1                Immunity
EMC Compliance: Australia/New Zealand	Meets the intent of Australian EMC Framework as demonstrated to the following specification:  AS/NZS 2064.1/2
EMC Compliance: Russia	This product was certified by the GOST ministry of Russia to be in compliance with all applicable EMC regulations.
FCC Compliance: U.S.A.	Emissions comply with FCC Code of Federal Regulations 47, Part 15, Subpart B, Class A Limits

**Specifications (Cont.)**

<b>Safety certifications and compliances</b>	
<p>EC Declaration of Conformity – Low Voltage (TDS3000 Series and P3010)  (P3010)  (P6139A)</p>	<p>Compliance was demonstrated to the following specification as listed in the Official Journal of the European Communities: Low Voltage Directive 73/23/EEC as amended by 93/68/EEC</p> <p>EN 61010-1/A2:1995 Safety requirements for electrical equipment for measurement, control, and laboratory use</p> <p>EN 61010-2-031:1995 Particular requirements for hand-held probe assemblies for electrical measurement and test equipment</p> <p>HD401 S1 Safety requirements for electronic apparatus</p>
<p>Approvals (TDS3000 Series and P3010)  (P3010)  (P6139A)</p>	<p>UL3111-1 – Standard for electrical measuring and test equipment CAN/CSA C22.2 No. 1010.1 – Safety requirements for electrical equipment for measurement, control and laboratory use</p> <p>EN 61010-2-031:1995 – Particular requirements for hand-held probe assemblies for electrical measurement and test equipment</p> <p>UL1244, Third Edition – Electronic measuring and test equipment CAN/CSA C22.2 No. 231.1-M89 – Test probes</p>
<p>Installation Category Descriptions</p>	<p>Terminals on this product may have different installation category designations. The installation categories are:</p> <p>CAT III Distribution-level mains (usually permanently connected). Equipment at this level is typically in a fixed industrial location</p> <p>CAT II Local-level mains (wall sockets). Equipment at this level includes appliances, portable tools, and similar products. Equipment is usually cord-connected</p> <p>CAT I Secondary (signal level) or battery operated circuits of electronic equipment</p>

## Appendix B: Factory Setup

The table below lists the state of the oscilloscope after you recall the Factory Setup.

<b>Control</b>	<b>Changed by factory setup to</b>
Acquire horizontal resolution	Normal (10,000 points)
Acquire mode	Sample
Acquire number of averages	16
Acquire number of envelopes	16
Acquire run/stop	Run
Acquire single sequence	Off
Channel selection	Channel 1 on, all others off
Coarse	No change
Confirm delete	No change
Cursor function	Off
Cursor H Bar 1 position	-3.2 divisions from the center
Cursor H Bar 2 position	+3.2 divisions from the center
Cursor H Bar units	Base
Cursor V Bar 1 position	10% of record
Cursor V Bar 2 position	90% of record
Cursor V Bar units	Seconds
Cursor tracking	Independent

<b>Control</b>	<b>Changed by factory setup to</b>
Display graticule type	Full
Display backlight	High
Display color palette	Normal
Dual waveform math function	Ch 1 + Ch 2
Edge trigger coupling	DC
Edge trigger level	0.0 V
Edge trigger slope	Rising
Edge trigger source	Channel 1
Horizontal delay	On
Horizontal delay time	0 ns
Horizontal trigger position	10%
Horizontal time/div	400 $\mu$ s/div
Horizontal zoom	Off
Horizontal zoom position	50%
Horizontal zoom time/div	400 $\mu$ s/div
Measure gating	Off (Full Record)
Measure high-low setup	Auto
Measure high reference	90% and 0 V
Measure low reference	10% and 0 V
Measure mid reference	50% and 0 V

<b>Control</b>	<b>Changed by factory setup to</b>
Overwrite lock	No change
Reference waveforms	No change
Saved setups	No change
Trigger holdoff	250.8 ns
Trigger mode	Auto
Trigger type	Edge
Utility language	No change
Utility date/time display	On
Utility I/O	No change
Utility hard copy	No change
Vertical bandwidth	Full
Vertical coupling	DC 1 M $\Omega$
Vertical invert	Off
Vertical offset	0 V
Vertical position	0 div
Vertical probe setup	Voltage, 1 X (unless non-1 X probe attached)
Vertical volts/div	100 mV/div
Video trigger standard	525/NTSC
Video trigger on	All lines
Waveform file format	No change
XY display	Off





# Appendix C: Accessories

## Standard Accessories

### P3010 10X passive probes (TDS3012 and TDS3014)

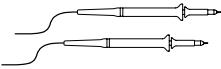

The P3010 10X passive probes have 100 MHz bandwidth and a CAT II voltage rating of 300 V<sub>RMS</sub>.

### P6139A 10X passive probes (TDS3032, TDS3034, TDS3052 and TDS3054)

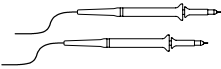

The P6139A 10X passive probes have 300 MHz or 500 MHz bandwidth and a CAT II voltage rating of 300 V<sub>RMS</sub>.

### Front cover

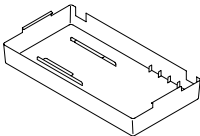

The front cover (200-4416-00) snaps onto the front of the oscilloscope to protect it during transit. The front cover contains a convenient location to store the Reference manual.

### Accessory tray

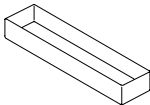

The accessory tray (436-0371-00) fits in the battery compartment when you do not have a battery installed. You can use the tray to store probes and other accessories.

### Manuals

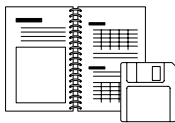

The oscilloscope includes a User Manual, Reference, and Online Tour Disk (020-2263-XX). Insert the disk into the oscilloscope disk drive to see an online tour of the product.

**Optional Accessories**

---

**TDS3FFT FFT application package**  
(standard with TDS3014, TDS3034, and TDS3054)



The FFT application package adds FFT analysis and measurement capability to your oscilloscope. Application packages can be installed by the user.

---

**TDS3TRG Advanced Triggering application package**  
(standard with TDS3014, TDS3034, and TDS3054)



The advanced triggering application package adds pulse-width, slew-rate, pattern, state, runt, and edge-delay triggering capability to your oscilloscope. Application packages can be installed by the user.

---

**TDS3VID Extended Video application package**



The extended video application package adds video trigger, display, and measurement capabilities to your oscilloscope. Application packages can be installed by the user.

---

**TDS3TMT Telecom Mask Test application package**



The telecom mask test application package adds ITU-T G.703, ANSI T1.102 (up to DS3 data rates), and custom mask testing capabilities to your oscilloscope. Application packages can be installed by the user.

---

**TDS3GM GPIB/RS-232 communication module**

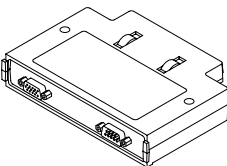

This communication module adds GPIB and RS-232 ports to your oscilloscope. You can attach a printer to these ports or use them for remote programmability. Communication modules can be installed by the user and include the *TDS3000-Series Programmer Manual* (in English only).

---

**Optional Accessories (Cont.)**

---

**TDS3VM VGA/RS-232 communication module**

---

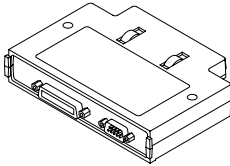

This communication module adds VGA and RS-232 ports to your oscilloscope. You can attach a printer to the RS-232 port or use it for remote programmability. You can attach a monitor to the VGA port to enhance viewing the screen from a distance. Communication modules can be installed by the user and include the *TDS3000-Series Programmer Manual* (in English only).

---

**TDS3EM Ethernet communication module**

---

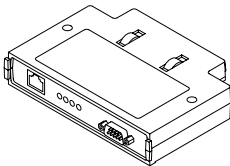

This communication module adds Ethernet 10baseT and RS-232 ports to your oscilloscope. You can attach the oscilloscope to an Ethernet network for remote printing. Communication modules can be installed by the user and include the *TDS3000-Series Programmer Manual* (in English only).

---

**TDS3CHG external battery charger**

---

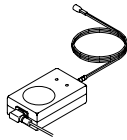

The battery charger recharges the oscilloscope battery pack in approximately 3 hours.

---

**TDS3BAT rechargeable battery pack**

---

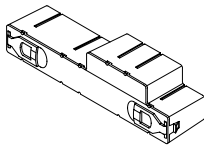

An extra rechargeable battery pack provides a high-capacity spare battery for extended portable operation.

---

**Optional Accessories (Cont.)**

---

**AC3000 soft case**

---



The soft case protects the oscilloscope when not in use. The soft case provides compartments for probes, one spare battery, battery charger, and the User Manual.

---

**RM3000 rack mount kit**

---

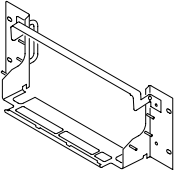

The rack mount kit contains all the hardware necessary to mount your oscilloscope in a standard rack. The kit requires 7 in of vertical space in the rack.

---

**WSTRO WaveStar Software for Oscilloscopes**

---



WaveStar is a Microsoft Office 97-compatible application that connects your oscilloscope to your PC. You can upload and download waveforms and setups. You can drag and drop acquired data into spreadsheets for further analysis, into word processors to integrate with your documentation, or to printers and plotters to make hard copies.

---

**Manuals**

---

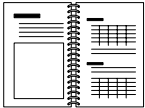

Service Manual (071-0382-XX) provides information about maintenance and module-level repair.

---

## Appendix D: Probe Basics

This chapter contains basic information about the P3010 or P6139A probes provided with your TDS3000 Series oscilloscope. It also contains information about other probes you can use with your oscilloscope and their limitations.

### Probe Descriptions

The P3010 and P6139A are high-impedance passive probes with the following general characteristics.

Characteristic	P3010	P6139A
Cable length	2 m	1.3 m
Compatibility	100 MHz oscilloscope models	300 MHz and 500 MHz oscilloscope models
Bandwidth	100 MHz	300 MHz or 500 MHz
Attenuation	10X	10X
Nominal input impedance	10 M $\Omega$ in parallel with 13.3 pF	10 M $\Omega$ in parallel with 8 pF
Maximum working voltage	300 V, CAT II, derated at 20 dB/decade to 50 V above 2.5 MHz	300 V, CAT II, derated at 20 dB/decade to 50 V above 2.5 MHz

## Probe Compensation

You should compensate a probe to an oscilloscope input whenever you attach a probe for the first time to any input channel. See page 1–3 for instructions to compensate probes.

When compensating the P3010, only adjust the trimmer marked L.

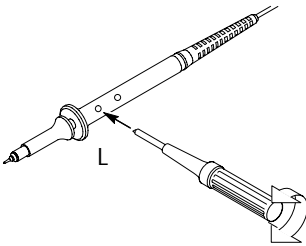

## TekProbe Interface

Probes with the TekProbe interface automatically communicate with the oscilloscope to set the probe type and attenuation factor. If you use a probe without the TekProbe interface, you can set these parameters in the Vertical menu for the channel that the probe is connected to.

## Probe Guard

A guard around the probe body provides a finger barrier for protection from electric shock.

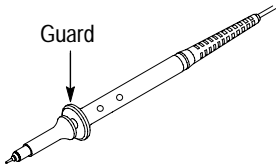

**WARNING.** To avoid electric shock when using the probe, keep fingers behind the guard on the probe body.

To avoid electric shock when using the probe, do not touch metallic portions of the probe head while connected to a voltage source.

## Ground Leads

Always use a ground lead when you probe a circuit to minimize noise pickup and signal aberrations. Connecting the ground lead to a point near the signal source usually provides the best results.

Long ground leads can cause false ringing and aberrations in the acquired waveform that are not in the actual signal. To see the best signal fidelity, use the shortest possible ground lead.

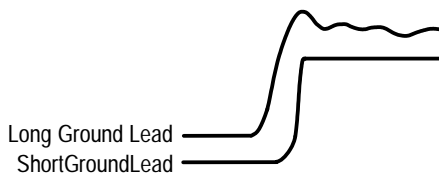

## P3010 High-Frequency Compensation

The P3010 high-frequency compensation should seldom require adjustment; however, your probe may require high-frequency adjustment if either of the following are true:

- the probe has high-frequency aberrations
- the probe does not perform at the rated bandwidth

To perform the high-frequency compensation adjustment you will need a signal source that has all of the following characteristics:

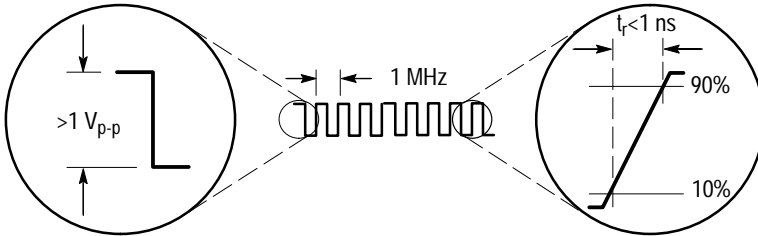

- square-wave output at 1 MHz
- fast rise output with rise time less than 1 ns
- output properly terminated



Connect the P3010 to the signal source to display a 1 MHz test signal on your oscilloscope. Use the BNC-to-probe tip adapter (013-0277-00) to make the connection. (The display should be similar to that shown below).

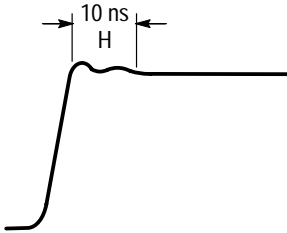

(a) Area Of Waveform Affected By Adjustment

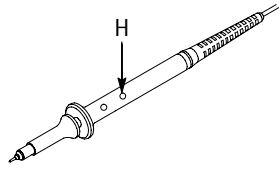

(b) Location of Adjustment

Adjust trimmer H until the waveform is flat on top and has a square leading edge.

## P3010 Replaceable Parts and Accessories

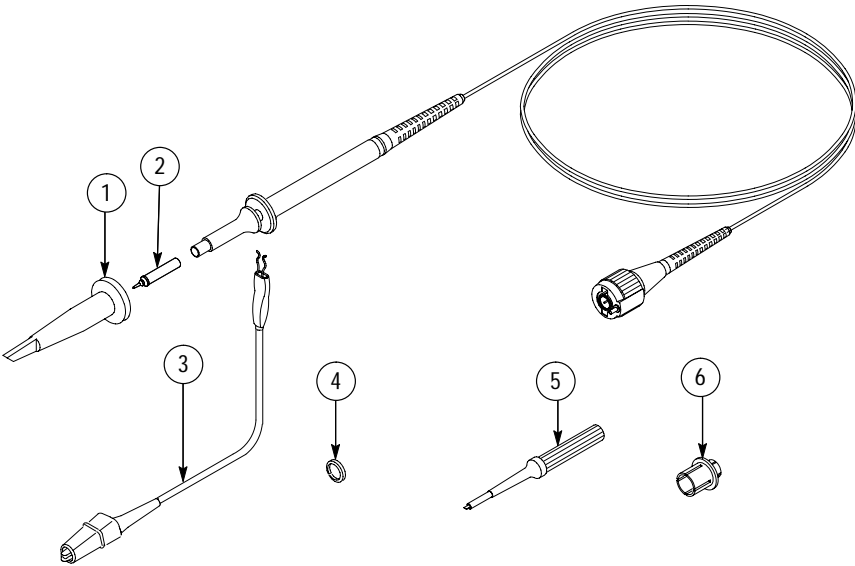

Standard Accessories

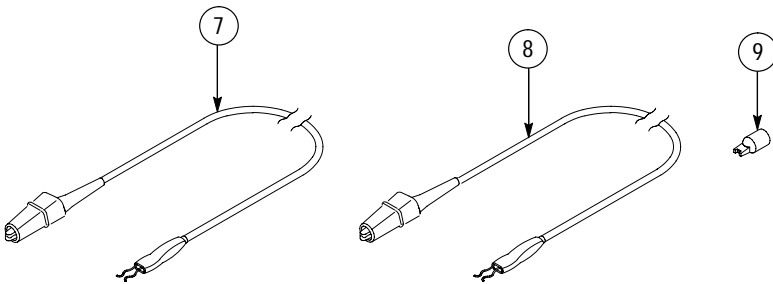

Optional Accessories

**P3010 replaceable parts and accessories**

<b>Index number</b>	<b>Description</b>	<b>Part number</b>
1	Retractable hook tip	013-0107-08
2	Probe tip	131-4997-01
3	Ground lead, 6 in	196-3120-01
4	Marker set (four colors, two each)	016-0633-00
5	Adjustment tool	003-1433-01
6	BNC-to-probe tip adapter	013-0277-00
7	Ground lead, 28 in	196-3120-21
8	Ground lead, 12 in	196-3121-01
9	IC test tip, package of 10	015-0201-07

# P6139A Replaceable Parts and Accessories

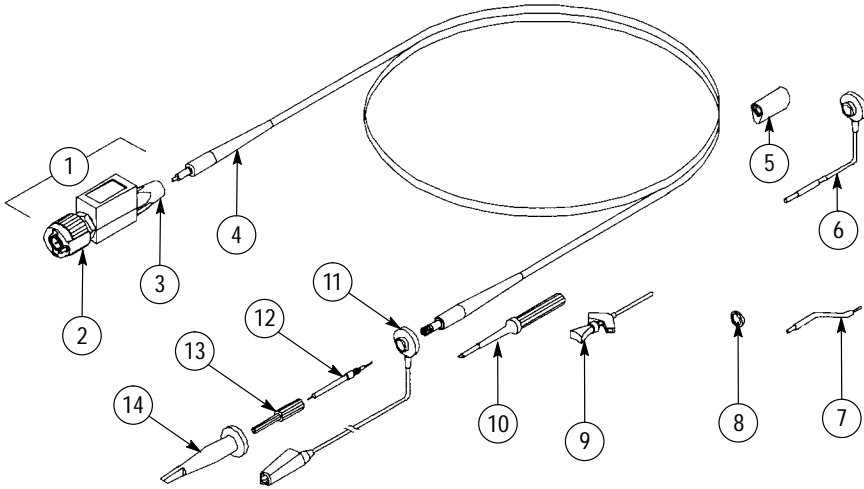

Standard Accessories

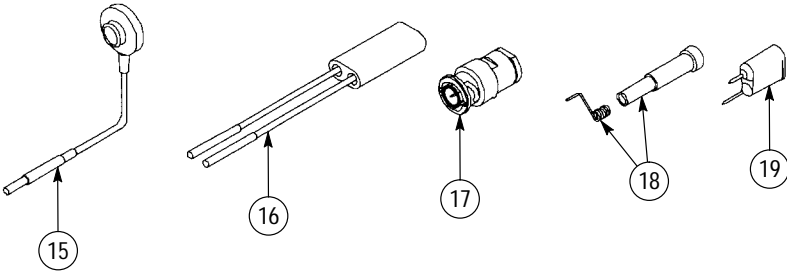

Optional Accessories

**P6139A replaceable parts and accessories**

<b>Index number</b>	<b>Description</b>	<b>Part number</b>
1	Compensation box assembly	206-0440-00
2	BNC connector	131-3219-00
3	Cable cover nipple	200-3018-00
4	Cable assembly	174-0978-00
5	Ground collar	343-1003-01
6	Ground lead, 6 in	196-3113-02
7	Ground lead, 2.3 in	195-4240-00
8	Marker set (four colors, two each)	016-0633-00
9	IC Klipchip grabber, package of 20	206-0364-00
01	Adjustment tool	003-1433-01
11	Ground lead with clip, 6 in	196-3305-00
12	Probe tip assembly	206-0441-00
13	Probe tip cover	204-1049-00
14	Retractable hook tip	013-0107-06
15	Ground lead, 3 in	196-3113-03
16	Probe to connector pin adapter	015-0325-00
17	50 $\Omega$ BNC-to-probe tip termination and adapter	013-0227-00
18	Ground contact kit (two each of five lengths) with cover shell	016-1077-00
19	Grounding probe tip	013-0085-00

## Using Other Probes

Optional probes can add capabilities to your oscilloscope that are useful in many applications.

### Passive Probes

You can use the following passive probes without any limitations.

Passive probe	Recommended usage
P6561A	SMT probe, 200 MHz, 10X
P6562A	SMT probe, 350 MHz, 10X
P6563A	SMT probe, 500 MHz, 20X
P5100	High-voltage probe, 2500 V <sub>pk</sub> CAT II, 250 MHz, 100X
P6015A	High-voltage probe, 20 kV DC, 75 MHz, 1000X
P6021	Current probe, 15 A, 120 Hz to 60 MHz
P6022	Current probe, 6 A, 935 Hz to 120 MHz

## Supported Active Probes

The oscilloscope supplies power to active probes. You can use the following active probes as long as the total power required by the probes does not exceed the capacity of the oscilloscope. To determine the total probe load, add the load factors for all probes you want to use. The oscilloscope can supply power to this combination if the sum of the load factors equals 10 or less. All passive probes have a load factor of zero.

Active probe	Recommended usage	Load factor
P6205	FET probe, 750 MHz, 10X	0
P6243	SMT probe, 1 GHz, 10X	0
P5205	High-voltage differential probe, 1300 V, 100 MHz, 50X or 500X	6
P5210	High-voltage differential probe, 5600 V, 50 MHz, 100X or 1000X	6
ADA400A	Differential preamplifier, 10 $\mu$ V sensitivity, DC to 10 kHz	5
AFTDS	Telecom differential 50 $\Omega$ adapter	0
AMT75	Telecom 75 $\Omega$ adapter	0
TCP202	Current probe, 15 A, DC to 50 MHz	4
013-0278-00	Video display clamp	5



**CAUTION.** To avoid a measurement error, do not connect active probes with a combined load factor that is greater than 10. The signal distortion caused by such an overload can be subtle (reduced gain, dynamic range, or slew rate).

## Unsupported Probes

The TDS3000 Series only supports the probes listed in this section of the manual. The oscilloscope may not display a message when you connect an unsupported probe, so make sure that any probe you connect to the TDS3000 is supported.



## Appendix E: Performance Verification

This appendix contains performance verification procedures for the specifications marked with the ✓ symbol. The following equipment, or a suitable equivalent, is required to complete these procedures.

Description	Minimum requirements	Examples
DC Voltage Source	3 mV to 4 V, $\pm 0.1\%$ accuracy	Wavetek 9500 Oscilloscope Calibrator with two 9510 Output Modules
Leveled Sine Wave Generator	50 kHz to 500 MHz, $\pm 3\%$ amplitude accuracy	
Time Mark Generator	10 ms period, $\pm 50$ ppm accuracy	
50 $\Omega$ feedthrough termination	BNC connectors	Tektronix part number 011-0099-00

You may need additional cables and adapters, depending on the actual test equipment you use.

These procedures cover all TDS3000 oscilloscope models. Please disregard checks that do not apply to the specific model you are testing.

Photocopy the test record on the next three pages and use them to record the performance test results for your oscilloscope.

## Test Record

Serial number	Procedure performed by	Date

Test	Passed	Failed
Self Test		

Performance checks		Low limit	Test result	High limit
Channel 1 DC measurement accuracy	1 mV/div	99.25 mV		100.8 mV
	2 mV/div	-7.540 mV		-6.460 mV
	5 mV/div	-101.8 mV		-98.24 mV
	50 mV/div	982.4 mV		1.018 V
	50 mV/div	632.4 mV		667.6 mV
	50 mV delta	340.5 mV		359.5 mV
	90 mV/div	-339.3 mV		-290.7 mV
	200 mV/div	9.900 V		10.10 V
	1 V/div	-10.30 V		-9.698 V

Performance checks		Low limit	Test result	High limit
Channel 2 DC measurement accuracy	1 mV/div	99.25 mV		100.8 mV
	2 mV/div	-7.540 mV		-6.460 mV
	5 mV/div	-101.8 mV		-98.24 mV
	50 mV/div	982.4 mV		1.018 V
	50 mV/div	632.4 mV		667.6 mV
	50 mV delta	340.5 mV		359.5 mV
	90 mV/div	-339.3 mV		-290.7 mV
	200 mV/div	9.900 V		10.10 V
	1 V/div	-10.30 V		-9.698 V
Channel 3 DC measurement accuracy	1 mV/div	99.25 mV		100.8 mV
	2 mV/div	-7.540 mV		-6.460 mV
	5 mV/div	-101.8 mV		-98.24 mV
	50 mV/div	982.4 mV		1.018 V
	50 mV/div	632.4 mV		667.6 mV
	50 mV delta	340.5 mV		359.5 mV
	90 mV/div	-339.3 mV		-290.7 mV
	200 mV/div	9.900 V		10.10 V
	1 V/div	-10.30 V		-9.698 V

Appendix E: Performance Verification

Performance checks		Low limit	Test result	High limit
Channel 4 DC measurement accuracy	1 mV/div	99.25 mV		100.8 mV
	2 mV/div	-7.540 mV		-6.460 mV
	5 mV/div	-101.8 mV		-98.24 mV
	50 mV/div	982.4 mV		1.018 V
	50 mV/div	632.4 mV		667.6 mV
	50 mV delta	340.5 mV		359.5 mV
	90 mV/div	-339.3 mV		-290.7 mV
	200 mV/div	9.900 V		10.10 V
	1 V/div	-10.30 V		-9.698 V
Channel 1 bandwidth		425 mV		—
Channel 2 bandwidth		425 mV		—
Channel 3 bandwidth		425 mV		—
Channel 4 bandwidth		425 mV		—
Channel 1 trigger sensitivity	rising slope	stable trigger		—
	falling slope	stable trigger		—
Channel 2 trigger sensitivity	rising slope	stable trigger		—
	falling slope	stable trigger		—
Channel 3 trigger sensitivity	rising slope	stable trigger		—
	falling slope	stable trigger		—
Channel 4 trigger sensitivity	rising slope	stable trigger		—
	falling slope	stable trigger		—
Sample rate and delay time accuracy		-2 divisions		+2 divisions

## Performance Verification Procedures

Before beginning these procedures, two conditions must first be met:

- The oscilloscope must have been operating continuously for ten minutes in an environment that meets the operating range specifications for temperature and humidity.
- You must perform the Compensate Signal Path operation described on page 1–4. If the operating temperature changes by more than 10° C, you must perform the Compensate Signal Path operation again.

The time required to complete the entire procedure is approximately one hour.



**WARNING.** *Some procedures use hazardous voltages. To prevent electrical shock, always set voltage source outputs to 0 V before making or changing any interconnections.*

---

### Self Test

This procedure uses internal routines to verify that the oscilloscope functions and passes its internal self tests. No test equipment or hookups are required. Start the self test with these steps:

1. Disconnect all probes and cables from the oscilloscope inputs.
2. Push the **UTILITY** menu button.
3. Push the **System** screen button to select **Diags**.
4. Push the **Loop** screen button and choose **Once**.
5. Push the **Execute** screen button.
6. Push the **OK Confirm Run Test** screen button.

A dialog box displays the result when the self test completes. Push the **MENU OFF** screen button to continue operation.

### Check DC Voltage Measurement Accuracy

This test checks the DC voltage measurement accuracy in the average acquisition mode.

1. Set the DC voltage source output level to **0 V**.
2. Connect the DC voltage source to the oscilloscope channel 1 input as shown below.

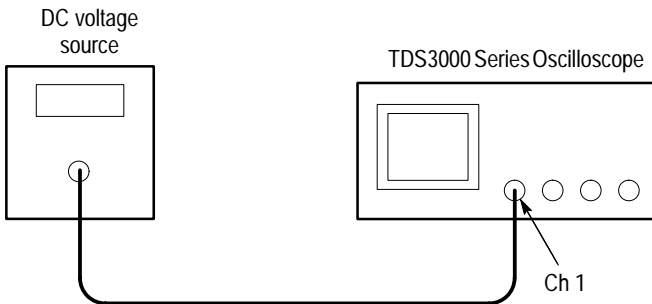

3. Push the **SAVE/RECALL** menu button.
4. Push the **Recall Factory Setup** screen button and then push the **OK Confirm Factory Init** screen button.
5. Push the acquire **MENU** button.
6. Push the **Mode** screen button and then push the **Average** screen button.
7. Adjust the number of averages to **16** with the general purpose knob.
8. Skip to step 11.

9. Move the DC voltage source output cable to the oscilloscope channel you want to check.
10. Push the channel button (**CH 1**, **CH 2**, **CH 3**, or **CH 4**) for the channel you want to check.
11. Push the **MEASURE** menu button.
12. Push the **Select Measurement** screen button.
13. Push the **– more –** screen button until you can select the **Mean** measurement.
14. Push the vertical **MENU** button.
15. For each row of the table on page E-9, do these steps:
  - a. Set the vertical **SCALE** control to the setting in the table.
  - b. Set the **Invert**, **Bandwidth Limit**, and **Offset** controls to the settings in the table.
  - c. Set the output of the DC voltage source to the voltage level in the table.
  - d. Verify that the oscilloscope **Mean** measurement is within the limits listed in the table on page E-8.
  - e. For the 50 mV delta measurement, subtract the second 50 mV measurement from the first 50 mV measurement; verify that the difference is within the limits stated in the Delta row of the table.
16. Repeat steps 15a through 15e for each row in the table.
17. Push the waveform off  button.
18. Repeat steps 9 through 17 for each channel of the oscilloscope (not including the external trigger input on some models).



Vertical SCALE setting	Invert setting	Band-width limit setting	Offset	Input voltage	Low limit	High limit
1 mV/div	Off	20 MHz	96.5 mV	100 mV	99.25 mV	100.8 mV
2 mV/div	Off	20 MHz	0.0 V	-7 mV	-7.540 mV	-6.460 mV
5 mV/div	Off	20 MHz	-82.5 mV	-100 mV	-101.8 mV	-98.24 mV
50 mV/div	Off	Full	825 mV	1.0 V	982.4 mV	1.018 V
50 mV/div	Off	Full	825 mV	650 mV	632.4 mV	667.6 mV
50 mV delta <sup>1</sup>					340.5 mV	359.5 mV
90 mV/div <sup>2</sup>	Off	Full	0.0 V	-315 mV	-339.3 mV	-290.7 mV
200 mV/div	Off	150 MHz <sup>3</sup>	9.3 V	10 V	9.900 V	10.10 V
1 V/div	On <sup>4</sup>	150 MHz <sup>3</sup>	-6.5 V	10 V	-10.30 V	-9.698 V

- <sup>1</sup> Refer to step 15e on page E-8 to calculate 50 mV delta measurement.
- <sup>2</sup> Push the Vertical MENU button, push the Fine Scale screen button, then use the general purpose knob to adjust setting to 90 mV/div.
- <sup>3</sup> Use the Full bandwidth setting on the TDS3012 or TDS3014 oscilloscopes.
- <sup>4</sup> Make sure to turn Invert setting to On for this measurement.

### Check Bandwidth

This test checks the bandwidth for each channel.

1. Connect the output of the leveled sine wave generator to the oscilloscope channel 1 input as shown below.

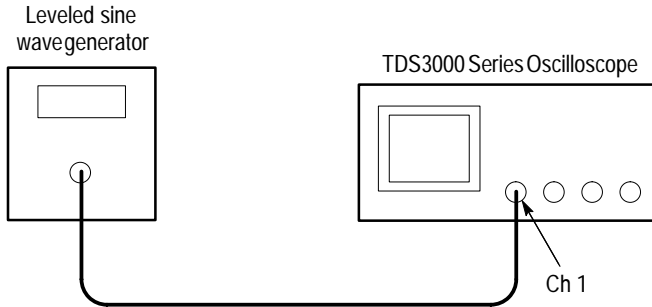

2. Push the **SAVE/RECALL** menu button.
3. Push the **Recall Factory Setup** screen button and then push the **OK Confirm Factory Init** screen button.
4. Push the acquire **MENU** button.
5. Push the **Mode** screen button and then push the **Average** screen button.
6. Adjust the number of averages to **16** with the general purpose knob.
7. Push the trigger **MENU** button.
8. Push the **Source** screen button and then push the **Vert** screen button.
9. Push the **Coupling** screen button and then push the **Noise Reject** screen button.
10. Skip to step 13.

11. Move the output cable of the leveled sine wave generator to the oscilloscope channel you want to check.
12. Push the channel button (**CH 1**, **CH 2**, **CH 3**, or **CH4**) for the channel you want to check.
13. Set the horizontal **SCALE** to **10  $\mu$ s/div**.
14. Push the vertical **MENU** button.
15. Push the **Coupling** screen button and select **50  $\Omega$**  input resistance.
16. Push the **MEASURE** menu button.
17. Push the **Select Measurement** screen button.
18. Push the – **more** – screen button until you can select the **Pk-Pk** measurement.
19. Set the vertical **SCALE** to **100 mV/div**.
20. Set the output frequency of the leveled sine wave generator to **50 kHz**.
21. Set the output amplitude of the leveled sine wave generator so the peak-to-peak measurement is between **599 mV** and **601 mV**.
22. Set the horizontal **SCALE** to **10 ns/div**.
23. Set the output frequency of the leveled sine wave generator to the frequency shown in the table below.

Oscilloscope model	Frequency
TDS3012, TDS3014	100 MHz
TDS3032, TDS3034	300 MHz
TDS3052, TDS3054	500 MHz

24. Verify that the peak-to-peak measurement is  $\geq 425$  mV.
25. Push the waveform off  button.
26. Repeat steps 11 through 25 for each channel of the oscilloscope (not including the external trigger input on some models).

### Check Channel Edge-Trigger Sensitivity

This test checks the edge-trigger sensitivity for each channel.

1. Connect the output of the leveled sine wave generator to the oscilloscope channel 1 input as shown below.

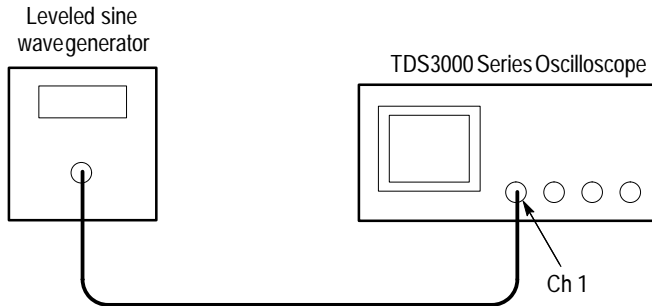

2. Push the **SAVE/RECALL** menu button.
3. Push the **Recall Factory Setup** screen button and then push the **OK Confirm Factory Init** screen button.
4. Push the acquire **MENU** button.
5. Push the **Mode** screen button and then push the **Average** screen button.
6. Adjust the number of averages to **16** with the general purpose knob.
7. Push the trigger **MENU** button.
8. Push the **Source** screen button and then push the **Vert** screen button.
9. Set the horizontal **SCALE** to **10 ns/div**.
10. Skip to step 13.

11. Move the output cable of the leveled sine wave generator to the oscilloscope channel you want to check.
12. Push the channel button (**CH 1**, **CH 2**, **CH 3**, or **CH4**) for the channel you want to check.
13. Push the vertical **MENU** button.
14. Push the **Coupling** screen button and select **50  $\Omega$**  input resistance.
15. Push the **MEASURE** menu button.
16. Push the **Select Measurement** screen button.
17. Push the **– more –** screen button until you can select the **Pk–Pk** measurement.
18. Set the vertical **SCALE** to **500 mV/div**.
19. Set the output frequency of the leveled sine wave generator to the frequency shown in the table below.

Oscilloscope model	Frequency
TDS3012, TDS3014	100 MHz
TDS3032, TDS3034	300 MHz
TDS3052, TDS3054	500 MHz

20. Set the output amplitude of the leveled sine wave generator so the peak-to-peak measurement is approximately **500 mV**.
21. Push the **SET TO 50%** button. Adjust the trigger **LEVEL** as necessary and then verify that triggering is stable.
22. Push the trigger **MENU** button.
23. Push the **Slope** screen button and select the \ (**falling**) slope.
24. Push the **SET TO 50%** button. Adjust the trigger **LEVEL** as necessary and then verify that triggering is stable.
25. Push the **Slope** screen button and select the / (**rising**) slope.
26. Push the waveform off  button.
27. Repeat steps 11 through 26 for each channel of the oscilloscope (not including the external trigger input on some models).

### Check Sample Rate and Delay Time Accuracy

This test checks the time base accuracy.

1. Connect the output of the leveled sine wave generator to the oscilloscope channel 1 input as shown below.

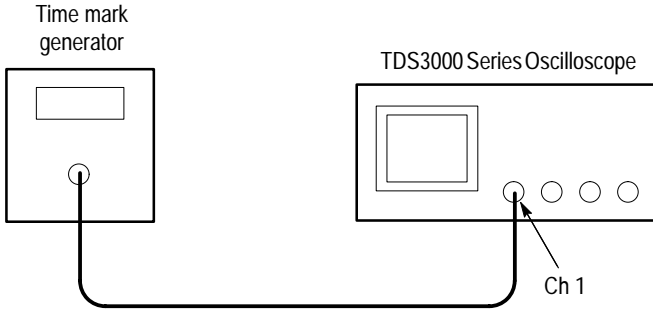

2. Push the **SAVE/RECALL** menu button.
3. Push the **Recall Factory Setup** screen button and then push the **OK Confirm Factory Init** screen button.
4. Set the time mark generator period to **10 ms**. Use a time mark waveform with a fast rising edge.
5. If adjustable, set the time mark amplitude to approximately **1 V<sub>p-p</sub>**.
6. Push the **DELAY** button to turn delay off.
7. Push the vertical **MENU** button.
8. Push the **Coupling** screen button and select **50 Ω** input resistance.



9. Set the vertical **SCALE** to **500 mV/div**.
10. Set the horizontal **SCALE** to **2 ms/div**.
11. Adjust the vertical **POSITION** control to center the time mark signal on the screen.
12. Adjust the trigger **LEVEL** as necessary to obtain a triggered display.
13. Adjust the horizontal **POSITION** control to move the trigger location to the center of the screen (50%).
14. Push the **DELAY** button to turn delay on.
15. Turn the horizontal **POSITION** control counter-clockwise to set the delay to exactly **10 ms**.
16. Set the horizontal scale to **1  $\mu$ s/div**.
17. Check that the rising edge of the marker crosses the center horizontal graticule line within  $\pm 2$  divisions of center graticule.

---

**NOTE.** *One division of displacement from graticule center corresponds to a 100 ppm time base error.*

---

This completes the performance verification procedure.



# Appendix F: General Care and Cleaning

## General Care

Protect the oscilloscope from adverse weather conditions. The oscilloscope is not water resistant.

Do not store or leave the oscilloscope where the LCD display will be exposed to direct sunlight for long periods of time.



**CAUTION.** To avoid damage to the oscilloscope, do not expose it to sprays, liquids, or solvents.

---

## Cleaning

Inspect the oscilloscope as often as operating conditions require. To clean the oscilloscope exterior, perform the following steps:

1. Remove loose dust on the outside of the oscilloscope with a lint-free cloth. Use care to avoid scratching the glass display filter.
2. Use a soft cloth or paper towel dampened with water to clean the oscilloscope. You can use a 75% isopropyl alcohol solution for more efficient cleaning.



**CAUTION.** To avoid damage to the surface of the oscilloscope, do not use any abrasive or chemical cleaning agents.

---





# Glossary



# Glossary

## **AC Coupling**

A mode that blocks the DC component of a signal but passes the dynamic (AC) component of the signal. Useful for observing an AC signal that is normally riding on a DC signal.

## **Acquisition**

The process of sampling signals from input channels, digitizing the samples, processing the results into data points, and assembling the data points into a waveform record. The waveform record is stored in memory.

## **Active Cursor**

The cursor that moves when you adjust the general purpose knob. The @ readout on the display shows the position of the active cursor.

## **Aliasing**

A false representation of a signal due to insufficient sampling of high frequencies or fast transitions. A condition that occurs when an oscilloscope digitizes at an effective sampling rate that is too slow to reproduce the input signal. The waveform displayed on the oscilloscope may have a lower frequency than the actual input signal.

## **Application Module**

A small module that you plug in to the front panel to add capabilities to your oscilloscope. You can use up to four application modules at one time.

## **Application Package**

An optional package that may include an application module, a firmware upgrade, and manuals that add capabilities to your oscilloscope.

**Attenuation**

The degree the amplitude of a signal is reduced when it passes through an attenuating device such as a probe or attenuator (the ratio of the input measure to the output measure). For example, a 10X probe attenuates, or reduces, the input voltage of a signal by a factor of 10.

**Auto Trigger Mode**

A trigger mode that causes the oscilloscope to automatically acquire if it does not detect a valid trigger event.

**Autoset**

A feature that automatically sets the vertical, horizontal, and trigger controls to provide a usable display.

**Average Acquisition Mode**

A mode in which the oscilloscope acquires and displays a waveform that is the averaged result of several acquisitions. The oscilloscope acquires data as in the sample mode and then averages it according to a specified number of averages. Averaging reduces uncorrelated noise in the displayed signal.

**Backlight**

The illumination behind the liquid-crystal display.

**B Trigger**

A second trigger system that works with the main (A) trigger to capture more complex events. You can use the dual A and B triggers to trigger after a given wait time or number of events.

**Cursors**

Paired markers that you can use to make measurements between two waveform locations. The oscilloscope displays the values (expressed in volts, time, or frequency) of the position of the active cursor and the distance between the two cursors.



**DC Coupling**

A mode that passes both AC and DC signal components to the circuit. Available for both the trigger system and the vertical system.

**Communication Module**

A optional module that adds I/O ports to the oscilloscope.

**Delay**

A means to delay the acquisition to start long after the trigger event has occurred. The trigger point does not have to be within the waveform record when delay is on.

**Digital Phosphor**

A term that describes the way the digitizing oscilloscope can simulate the acquisition behavior of an analog oscilloscope. Displayed points vary in intensity depending on the frequency of their acquisition and then decay as if the oscilloscope had an analog CRT (cathode ray tube).

**Digital Real Time Digitizing**

A digitizing technique that samples the input signal with a sample frequency of four to five times the oscilloscope bandwidth. Combined with  $(\sin x)/x$  interpolation, all frequency components of the input up to the bandwidth are accurately displayed.

**Digitizing**

The process of converting a continuous analog signal such as a waveform to a set of discrete numbers representing the amplitude of the signal at specific points in time.

**Edge Trigger**

Triggering that occurs when the oscilloscope detects the source passing through a specified voltage level in a specified direction (the trigger slope).

**Envelope Acquisition Mode**

A mode in which the oscilloscope acquires and displays a waveform that shows the variation extremes of several acquisitions.

**External Trigger**

Triggering that occurs when the oscilloscope detects the external input signal passing through a specified voltage level in a specified direction (the trigger slope).

**Floating Measurements**

Voltage measurements where the reference voltage is not earth ground.

**General Purpose Knob**

A knob on the front panel that you can use to set parameters, for example, cursor position. The specific parameter assigned to the general purpose knob depends on other selections.

**Gray Scale**

The waveform display capable of showing points at different intensities, depending on the frequency of their occurrence. Color “gray scale” consists of light and dark shades of the color.

**Ground (GND) Coupling**

Coupling option that disconnects the input signal from the vertical system.

**Ground Lead**

The reference lead for an oscilloscope probe.

**Ground Wire**

A wire that must be connected between the ground terminal and earth ground when using the oscilloscope with battery power.

**Hard Copy**

An electronic copy of the display in a format useable by a printer or plotter.

**Holdoff**

A specified amount of time that must elapse after a trigger signal before the trigger circuit will accept another trigger signal. Holdoff helps ensure a stable display.

**Horizontal Bar Cursors**

The two horizontal bars that you position to measure the voltage parameters of a waveform. The oscilloscope displays the value of the active (moveable) cursor with respect to ground and the voltage value between the bars.

**Menu**

A set of labels shown in the display to identify the functions of the bezel buttons. The specific menu contents depend on the menu button you press.

**Normal Trigger Mode**

A mode where the oscilloscope does not acquire a waveform record unless a valid trigger event occurs. It waits for a valid trigger event before acquiring waveform data.

**Peak Detect**

An acquisition mode that captures spikes and glitches that may occur between normal sample points.

**Persistence**

The decay of waveform points. With persistence turned off, the points decay quickly. With persistence on, the points decay more slowly or not at all, depending on the setting.

**Pixel**

A visible point on the display. The display is 640 pixels wide by 480 pixels high.

**Pretrigger**

The specified portion of the waveform record that contains data acquired before the trigger event.

**Preview**

The oscilloscope capability to show you what the next acquisition might look like if you change control settings while acquisition is stopped or waiting for the next trigger. The new control settings take effect for the next acquisition. Both horizontal and vertical preview are available.

**QuickMenu**

An alternate display presentation that lets you control the most commonly used functions with the screen buttons. Optional application packages may have an available QuickMenu display.

**Record Length**

The specified number of samples in a waveform.

**Reference Waveform**

A saved waveform selected for display. You can save and display up to four reference waveforms.

**Roll Mode**

An acquisition mode useful at slow horizontal scale settings. Roll mode allows you to view the waveform as it is acquired point-by-point. The waveform appears to roll across the display.

**RS-232**

The serial communication port used to connect to a hard-copy device, computer, controller, or terminal.

**Sample Acquisition Mode**

A mode in which the oscilloscope creates a record point by saving the first sample during each acquisition interval. This is the default mode of the acquisition system.

**Sample Interval**

The time interval between successive samples in a time base. For real-time digitizers, the sample interval is the reciprocal of the sample rate.

**Sampling**

The process of capturing an analog input, such as a voltage, at a discrete point in time and holding it constant so that it can be quantized.

**Scope QuickMenu**

A built-in QuickMenu that places the most commonly used oscilloscope controls around the screen. With the Scope QuickMenu, you may not need to use the main menu system to operate the oscilloscope.

**Screen Buttons**

The rows of buttons below and to the right of the display that select items in the menus.

**Selected Waveform**

The waveform on which all measurements are performed and which is affected by vertical position and scale adjustments.

**Signal Path Compensation (SPC)**

The ability of the oscilloscope to minimize the electrical offsets in the vertical, horizontal, and trigger amplifiers caused by ambient temperature changes and component aging. You should run SPC when the ambient temperature varies more than 5° C from the last SPC or before performing critical measurements.

**Single Sequence**

A single shot acquisition if Sample or Peak-detect acquisition mode is selected. A series of N acquisitions if Average or Envelope acquisition mode is selected (N is the number of averages or envelopes).

**Standby (STBY)**

The off-like state when the instrument is not in use. Some circuits are active even while the instrument is in the standby state.

**TekProbe Interface**

An interface that communicates information between a probe and the oscilloscope, such as the probe type and its attenuation factor. The interface also supplies power to active probes.

**Tek Secure**

A feature that erases all waveform and setup memory locations (setup memories are replaced with the factory setup). Then it checks each location to verify erasure. This feature is useful where the oscilloscope is used to gather security-sensitive data.

**Time Base**

The set of parameters that let you define the time and horizontal axis attributes of a waveform record. The time base determines when and how long to acquire record points.

**Vertical Bar Cursors**

The two vertical bars you position to measure the time parameter of a waveform record. The oscilloscope displays the value of the active (moveable) cursor with respect to trigger and the time value between the bars.

**Video Trigger**

Triggering on the sync pulse of a composite video signal.

**XY Format**

A display format that compares the voltage level of two waveform records point by point. It is useful for studying phase relationships between two waveforms.

**YT Format**

The conventional oscilloscope display format. It shows the voltage of a waveform record (on the vertical axis) as it varies over time (on the horizontal axis).

**Zoom**

The horizontal magnification capability of the oscilloscope. Zoom is a display function; adjusting zoom does not affect the acquired waveform.







# Index



# Index

## Symbols

.gz file format, 3–23

## A

- accessories, C–1
- acquisition
  - menu, 3–6
  - modes, 3–7
  - overview, 1–5
  - rate, 3–11
  - resolution, 3–11
  - single shot, 2–20, 3–3
  - status, 3–2
  - stopped, 3–2
  - waiting for trigger, 3–2
- active cursor, 3–14
- adjusting probes, 1–3
- amplitude measurement, 3–37
- application modules
  - descriptions, C–2
  - installing, 1–15
- applications
  - autoset, 2–2
  - averaging, 2–11
  - cursors, 2–12
  - custom measurements, 2–6
  - delay, 2–13
  - examples, 2–1
  - gray scale, 2–19
  - measurements, 2–3, 2–5
  - measuring jitter, 2–15
  - peak detect, 2–10
  - video, 2–16
  - zoom, 2–22

## AUTOSET

- button, 3–4
- undo, 3–4
- averaging, 3–7

## B

- B TRIG button, 3–50
- B trigger, how to use, 3–50
- backlight
  - intensity, 3–17
  - timeout, 3–63
- bandwidth selection, 3–72
- battery
  - charging, 1–14, C–3
  - installation, 1–12
  - power, 1–10
  - recycling, vii
  - safety, 1–11
- burst width measurement, 3–37

## C

- calibration, 1–4, 3–67
- cleaning, F–1
- clear spool, 3–23
- COARSE button, 3–14
- color
  - display, 3–19
  - printing, 3–23
- communication modules
  - description, C–2
  - installing, 1–17
- compressing hard copy files, 3–23
- constellation diagram, 3–20

### cursors

- active, 3–12
  - application example, 2–12
  - gating, 2–8, 3–35
  - interactions, 3–36
  - locating, 3–14
  - measurements, 2–12
  - measurements when cursors at same position, 3–16
  - menu, 3–12
  - readouts, 3–15
  - tracking mode, 3–16
  - V Bars and FFT measurements, 3–16
- cycle mean measurement, 3–37
- cycle RMS measurement, 3–37

## D

- date/time, how to use, 3–62
- delay
- example application, 2–13
  - how to use, 3–27
  - interactions, 3–28, 3–31, 3–32
- DELAY button, 3–27
- deskew, probe, 3–72
- diagnostics, 3–68
- digital phosphor, 3–5
- disk, online tour, C–1
- disk drive
- application example, 2–23
  - how to use, 3–43
- display
- colors, 3–19
  - identifying items in, 1–26
  - menu, 3–17
  - overview, 1–6
  - persistence, 3–19
  - roll mode, 3–32
  - slow horiz. settings, 3–31

## E

- edge trigger, 3–55
- envelope, 3–7
- error log, 3–69
- ESD handling precautions, vii
- Ethernet, 3–66
- external trigger, 3–57

## F

- factory calibration, 3–68
- factory setup, detailed description, B–1
- fall time measurement, 3–37
- fast trigger, 3–11
- file compression, hard copy, 3–23
- file system
- application example, 2–23
  - extensions, 3–48
  - formatting a disk, 3–47
  - how to use, 3–43
  - protections, 3–47
- firmware upgrade, 3–44
- FORCE TRIG button, 3–50
- frequency measurement, 3–37
- front panel
- identifying connectors, 1–30
  - identifying controls, 1–21
- functional check, 1–2

## G

- gated xyz, 3–20
- GPIB, 3–66
  - communication module, C–2
- gray scale
  - application example, 2–19
  - controlling, 3–5
  - losing information, 3–30
  - measurements, 3–15
  - restrictions, 3–75, 3–77

## H

- hard copy. *See* printing
- hard copy file compression, 3–23
- high level measurement, 3–37
- holdoff, 3–58
- horizontal
  - expansion marker, 3–26
  - position, 3–25
  - resolution, 3–11
  - scale, 3–29
- horizontal preview
  - application example, 2–21
  - interactions, 3–30
- horizontal zoom
  - application example, 2–22
  - how to use, 3–29
  - interactions, 3–30
  - maximum, 3–30

## I

- I/O ports, 3–64
- initial setup, 1–1
- ink saver, 3–23

## L

- language, how to select, 3–61

## M

- magnify. *See* zoom
- math
  - preview, 3–75
  - source waveform screen position, 3–75
- math waveform, 3–74
- max measurement, 3–37
- mean measurement, 3–37
- measurements
  - cursor, 2–12
  - gating, 2–8, 3–35
  - interactions, 3–34
  - menu, 3–33
  - reference levels, 2–7
  - V Bars and FFT, 3–16
- menus, how to use, 1–18
- min measurement, 3–37

## N

- negative measurement
  - duty cycle, 3–38
  - overshoot, 3–38
  - width, 3–38

## O

- online tour disk, C–1

### P

- peak detect, 3–7
- peak-to-peak measurement, 3–38
- performance verification, E–1
- period measurement, 3–38
- persistence, 3–19
- positive duty cycle measurement, 3–38
- positive overshoot measurement, 3–38
- positive width measurement, 3–38
- power
  - AC line, 1–9
  - battery, 1–10
  - probe, D–11
- power cord, 1–9
- power off timeout, 3–62
- pretrigger, 3–25
- preview
  - application example, 2–21
  - horizontal, 3–30
  - vertical, 3–73
- printing
  - color, 3–23
  - connections, 3–21
  - date/time stamp, 3–24
  - error message, 3–24
  - hard copy file compression, 3–23
  - ink saver, 3–23
  - preview, 3–23
  - printer compatibility, 3–22
  - spooler, 3–23
- probe compensation, 1–3
- probe deskew, 3–72
- probes
  - compensating, 1–3
  - general information, D–1
  - power limitations, D–11
  - safety information, D–3

- product description

- accessories, C–1
- models, 1–4
- overview, 1–5
- probes, D–10

### Q

- QuickMenu, 1–28
  - how to use, 3–39
  - identifying menu items, 1–28

### R

- readouts, cursors, 3–15
- rear panel, identifying connectors, 1–31
- record length, 3–11
- reference
  - scale and position, 3–75, 3–77
  - waveforms, 3–76
- removing waveforms, 3–70
- rise time measurement, 3–38
- RMS measurement, 3–38
- roll mode, 3–32
- RS-232
  - communication module, C–2
  - troubleshooting, 3–66
- RUN/STOP button, 3–2

### S

- safety, battery operation, 1–11
- sample, 3–7
- save/recall
  - menu, 3–40
  - setups, 3–41
  - waveforms, 3–42, 3–76

saved waveforms  
  formats, 3-44  
  naming, 3-44  
  printing, 3-46  
SELECT button, 3-14  
self test, 3-68  
SET TO 50% button, 3-49  
signal path compensation, 1-4,  
  3-67  
signal processing, overview, 1-5  
SINGLE SEQ button, 3-3  
single shot, 3-3  
  application example, 2-20  
slow roll mode, 3-31  
specifications, A-1  
status  
  acquisition, 3-2  
  trigger, 3-54  
stopped acquisition, 3-2

## T

Tek Secure, how to use, 3-63  
TekProbe interface, 3-72, D-2  
time base  
  controlling, 3-29  
  fast settings, 3-31  
time-out, 3-62  
trigger  
  auto, 3-57  
  edge, 3-55  
  external, 3-57  
  holdoff, 3-58  
  level, 3-49  
  menu, 3-49  
  normal, 3-57  
  position marker, 3-26  
  status, 3-54  
  video, 3-59  
  XY waveforms, 3-19

## U

undo autoset, 3-4  
utility menus, 3-60

## V

vertical  
  menu, 3-71, 3-74, 3-76  
  offset, 3-73  
  position, 3-70  
  preview, 3-73  
  scale, 3-70  
video modulation, application  
  example, 2-19  
video trigger, 3-59  
  application example, 2-16  
  sync pulse, 3-59

## W

WAVEFORM INTENSITY, 3-5  
waveform off, 3-70  
waveform record icon, 1-27

## X

XY waveform  
  controlling, 3-19  
  gated xyz, 3-20  
  restrictions, 3-20  
  triggering, 3-19

## Z

### zoom

- application example, 2–22
- how to use, 3–29
- interactions, 3–30
- maximum, 3–30