

USER'S GUIDE

Intelligent Picomotor™ Control Modules

*Driver, Controllers, I/O Modules,
Joystick, and Hand Terminal*

U.S. Patents #5,394,049, #5,410,206



*Use of controls or adjustments, or performance of procedures
other than those specified herein may result in exposure to
high voltages.*



NEW FOCUS®

2584 Junction Ave. • San Jose, CA 95134-1902 • USA
phone: (408) 919-1500 • e-mail: contact@newfocus.com • www.newfocus.com


Warranty

New Focus, Inc. guarantees its products to be free of material and workmanship defects for one year from the date of shipment. This warranty is in lieu of all other guarantees expressed or implied and does not cover incidental or consequential loss.

Products described in this document are covered by U.S. Patents #5,394,049 and #5,410,206.

Information in this document is subject to change without notice.

Copyright 2003, 2002–1998, New Focus, Inc. All rights reserved.

Picomotor is a trademark, and the  **NEW FOCUS**® logo and NEW FOCUS, Inc. are trademarks of NEW FOCUS, Inc. Rabbit 2000 is a trademark of Rabbit Semiconductor. LabVIEW is a trademark of National Instruments Corporation. Visual Basic and Windows are registered trademarks of Microsoft Corporation.

Document Number 872209 Rev. C.4

Contents

Introduction	7
Overview	7
General Picomotor Concepts	16
Picomotor Products and Accessories	18
Software Options	21
User Safety	22
Setting Up	23
Overview	23
Driver Kits with Joystick and/or Hand Terminal	25
Using MCL with the Network Controller	26
Using MCL with the Ethernet Controller	28
Using MCL with the Ethernet Controller and Hand Terminal	31
Using MCL with a Serial Port and PC, Hand Terminal, Joystick, and/or Ethernet Controller	32
Using DLL/DCN with the Driver(s) Only	32
Using DLL/DCN with the Driver(s) and I/O Module(s)	34
Using DLL/DCN with the Driver(s), I/O Module(s), and Joystick	35
Manual Control: Using the Hand Terminal or Joystick	37
Overview	37
Using the Hand Terminal	37
Using the Joystick	39

Computer Control: Using MCL	45
Overview	45
Using the RS-232 Interface.....	45
Using the Ethernet	48
Using the Hand Terminal	54
Rules of Operation	55
Programming for the Network or Ethernet Controller.....	55
Conventions	57
Command Summary	57
Command Definitions.....	61
Examples	99
Computer Control: Using the DCN Interface	101
Overview	101
Using the RS-485 Interface.....	101
Rules of Operation	102
Model 8753 Picomotor Driver Control Panel.....	103
Model 8751-C Closed-Loop Driver Control Panel .	108
Joystick Control Panel	111
I/O Modules Control Panel.....	113
Computer Control: Using DLLs	115
Overview	115
Using the RS-485 Interface.....	116
Using the LabVIEW Interface	117
Programming for the Driver(s), I/O Module(s), and Joystick.....	120
Conventions	120
Command Summary	122
Command Definitions.....	125
Example	172
Computer Control: Global Definitions	179
Addressing	179
Intelligent Picomotor Driver	180
Closed-Loop Picomotor Driver	187
Joystick.....	192

Troubleshooting	193
Closed-Loop Picomotor Driver	193
Joystick.....	194
Hand Terminal	196
Network Controller	196
Ethernet Controller	197
Specifications	199
Model 8753 Intelligent Picomotor Drivers.....	199
Model 8751-C Closed-Loop Picomotor Drivers ...	203
Model 8750 Intelligent Picomotor Network Controller	208
Model 8752 Intelligent Picomotor Ethernet Controller	213
Model LS-773 Open Collector I/O Module.....	219
Model LS-784 Open Emitter I/O Module	224
Model 8754 Intelligent Picomotor Joystick	230
Model 8757 Hand Terminal.....	233
Driver Kit Power Supply.....	234
Models 8301–8341, 8301–8341, and 8351 Picomotors.....	236
Model 8310 Closed-Loop Picomotor	238
Customer Service	241
Technical Support	241
Service	241

Introduction

Overview

The Picomotor™ is a motorized actuator designed for applications requiring a compact, high-resolution positioner. New Focus offers the Picomotor as a stand-alone actuator as well as integrated into mounts and stages. The Picomotor has a linear resolution of less than 30 nm for Standard Picomotors and less than 100 nm for Tiny Picomotors. The Intelligent Picomotor drivers generate the electronic pulses that provide open- or closed-loop control of the Picomotors.

The Intelligent Picomotor control modules—including the Model 8753 Intelligent Picomotor Driver, the Model 8751-C Closed-Loop Picomotor Driver, the Model LS-773 Open Collector Module, the Model LS-784 Open Emitter I/O Module, the Model 8750 Intelligent Picomotor Network Controller, the Model 8752 Intelligent Picomotor Ethernet Controller, the Model 8754 Intelligent Picomotor Joystick, and the Model 8757 Intelligent Picomotor Hand Terminal—offer a compact, rugged, and versatile method for controlling New Focus Picomotors.

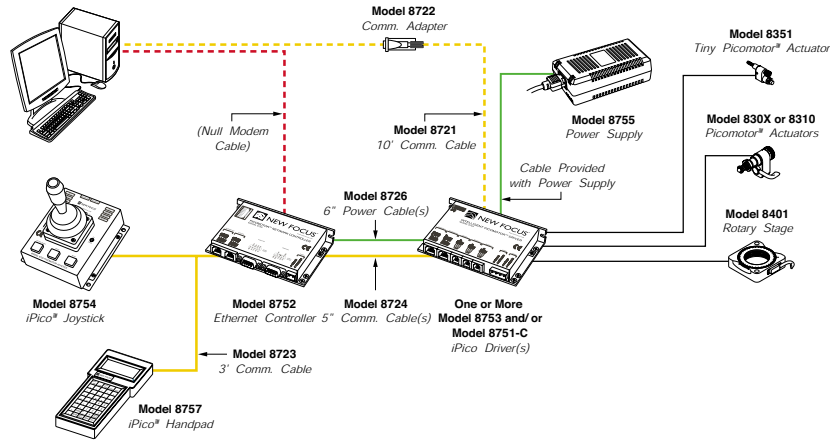
Each controller network can contain up to 31 drivers or I/O devices, to control up to a maximum of 93 picomotors.

The Model 8763-KIT Picomotor driver kits include a controller and a driver. When supplemented with a joystick or hand terminal, the driver kit can be used for stand-alone operation.

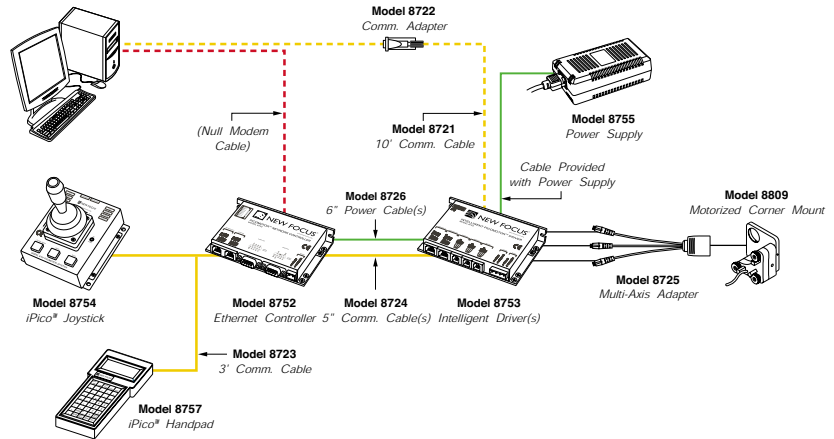
Figure 1 shows how the components of the Intelligent Picomotor network can be configured for different motion control applications. The following sections describe the individual components in detail.

Figure 1: How the components an Intelligent Picomotor network fit together

Driving single axis devices with the iPico control modules



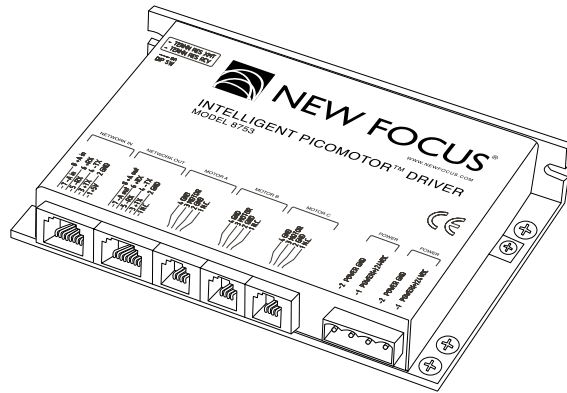
Driving multi-axis devices with the iPico control modules



Intelligent Picomotor Drivers

Each Model 8753 Intelligent Picomotor Driver can drive up to three individual Picomotors, asynchronously, through its three 4-pin single-channel output ports. (For multi-axis devices that use 6-pin connectors, such as optical mounts, you will need to use a Model 8725 multi-axis adapter.)

Figure 2:
Model 8753
Intelligent
Picomotor Driver



Each driver is a member of the Distributed Control Network (DCN). Up to 31 DCN devices can be controlled over a multi-drop full-duplex RS-485 network. Standard RJ-45 connectors and commercially available cables are used to connect the drivers into a network. A DLL library is available free of charge on the New Focus web site to facilitate the integration of Picomotor Drivers into your custom applications.

Closed-Loop Picomotor Drivers

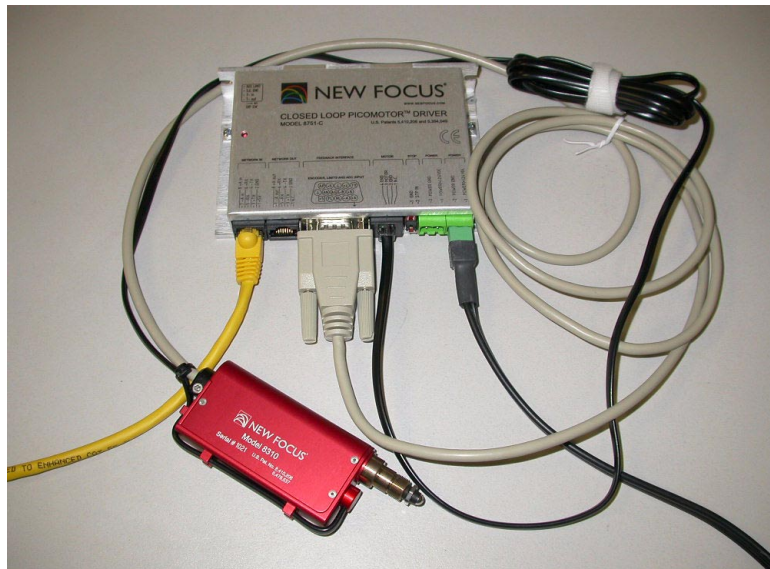
The Model 8751-C Closed-Loop Driver can drive a single Picomotor through its 4-pin single channel port. When used with the Model 8310 closed-loop Picomotor actuator, it offers an ideal solution for applications where closed-loop control and absolute position calibration is required.

Up to 31 Model 8751-C drivers can be controlled with the Model 8752 network controller, or the driver can be combined with other DCN modules to create a mixed system of closed- and open-loop control.

Figure 3:
Model 8751-C
Closed-Loop Driver

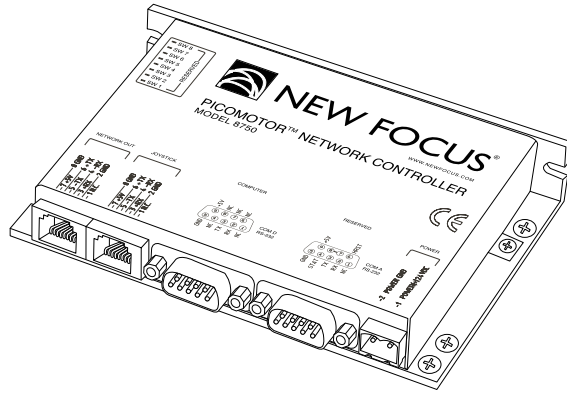


Figure 4: Model
8751-C Closed-
Loop Driver with
Model 8310
Closed-Loop
Picomotor



Intelligent Picomotor Network Controllers

Figure 5:
Model 8750
Intelligent
Picomotor Network
Controller



The Model 8750 Intelligent Picomotor Network Controller can be used as an interface between a computer and up to 31 Model 8753 drivers using a standard RS-232 serial interface, or it can be used with the joystick and Model 8753 drivers for manual control of Picomotors. Standard RJ-45 connectors and commercially available cables are used to connect the controller to the drivers and the joystick. The MCL commands described in the “Computer Control: Using MCL” chapter beginning on page 45 can be used to integrate the Picomotor Network Controllers into your custom applications.

Note:

The Model 8750 network controller does not support the Model 8751-C driver. To create a network with the Model 8751-C driver, you will need to use the Model 8752 Ethernet Controller.

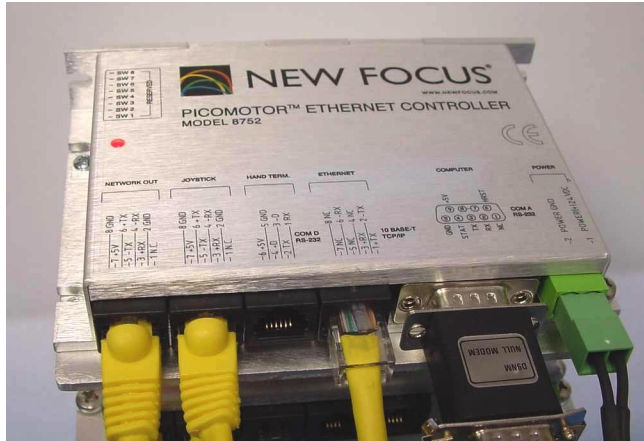
Intelligent Picomotor Ethernet Controller

The Model 8752 Intelligent Picomotor Ethernet Controller can be used to interface a computer, located anywhere, with up to 31 Model 8753 and/or 8751-C Picomotor drivers using a standard TCP/IP Ethernet or RS-232 serial interface. It can also be used with the Model 8754 Joystick or Model 8757 Hand Terminal for manual control of Picomotors. It allows for both simultaneous operation by multiple users with multiple ports and operation through a single port.

The Model 8752 Ethernet Controller differs from the Model 8750 Network Controller in two ways: it has an Ethernet communication

port, and it has a plug-in port for the Model 8757 Hand Terminal. The Ethernet port supports dynamic or static IP addressing and telnet communication.

Figure 6:
Model 8752
Ethernet Controller



Note:

The Model 8752 Ethernet controller needs to have its firmware upgraded to at least version 1.5.0 to support the Model 8751-C closed loop drivers. The latest revision can be downloaded from the New Focus web site and installed with a PC and null-modem cable.

Intelligent Picomotor Hand Terminal

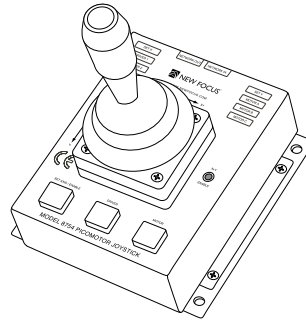
The Model 8757 Intelligent Picomotor Hand Terminal is an ASCII terminal for use with the Model 8752 Ethernet Controller. It features a 45-key keypad and a liquid crystal alphanumeric display that can show up to four lines of 20 characters each. The terminal provides both preprogrammed shortcut keys for simple Picomotor control and a standard keypad to allow users to type in individual MCL commands.

Figure 7:
Model 8757
Hand Terminal



Intelligent Picomotor Joysticks

Figure 8:
Model 8754
Intelligent
Picomotor Joystick



The Model 8754 Intelligent Picomotor Joystick is a multifunction I/O device designed for a wide range of applications. When used with the Model 8750 network controller, it can control up to three Model 8753 and/or Model 8751-C drivers (nine standard or three closed-loop Picomotors).

The joystick, like the drivers, is also a member of the DCN, and can be programmed to control any Picomotor on any driver in the DCN using the available DLL library.

Intelligent Picomotor Driver Kit

Figure 9:
The driver kit includes an Ethernet controller, driver, required cables, and power supply



The driver kits provide an out-of-the-box solution for controlling Picomotors. Each kit includes a Model 8752 Ethernet controller, a power supply, and one Model 8753 Intelligent Picomotor Driver. The kits also include mounting bracket(s) and all required cables.

Intelligent Picomotor Open Emitter I/O Module

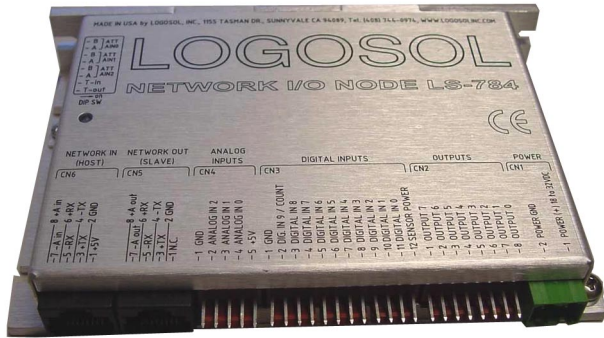
The Model LS-784 Open Emitter Module is a multifunctional I/O controller that can be used for a wide range of applications. Designed as a member of Distributed Control Network (DCN), it can control up to 31 DCN nodes over a multi-drop full-duplex RS-485 network.

The module supports 10 digital inputs and three analog inputs, and it provides eight digital “open emitter” outputs capable of sourcing 0.5A.

Features include:

- Three analog inputs, 0-5V, 0-10V, 0-20V, 0-30V (dip-switch individually selectable), 8-bit precision
- 10 digital inputs
- Eight digital outputs
- Two outputs are PWM-controllable, 8-bit precision
- One input is configurable as counter or timer input with prescaler

Figure 10: Model
LS-784 Open
Emitter Module



Intelligent Picomotor Open Collector I/O Module

The Model LS-773 Open Collector Module is a multifunctional, I/O controller designed for a wide range of applications. Up to 31 LS-773 nodes can be controlled over a multi-drop full-duplex RS-485 network. There are 10 general purpose digital inputs and three analog inputs with six open collector outputs capable of driving up to 1A and one solid-state relay power source output (5A maximum).

Features include:

- Three analog inputs, 0-5V, 0-10V, 0-20V, and 0-30V (dip-switch individually selectable), 8-bit precision
- 10 digital inputs
- Eight digital outputs
- Two outputs are PWM-controllable, 8-bit precision
- One input is configurable as counter or timer input with prescaler

Figure 11: Model
LS-773 Open
Collector Module



Intelligent Picomotor Power Cable

The Model 8729 Power Cable is available for the Model LS-773 and LS-784 I/O Modules. This cable provides a single power supply for the drivers, controller, and I/O modules.

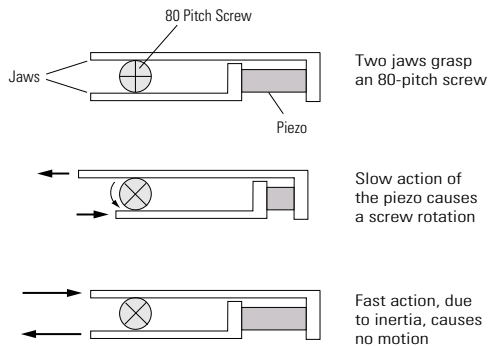
Figure 12:
Model 8729
Power Cable



General Picomotor Concepts

The key element in our motorized mechanical line is the Picomotor. The Picomotor's revolutionary design relies on the principles of static and dynamic friction. Two jaws grasp an 80-pitch screw, and a piezoelectric transducer slides the jaws in opposite directions.

Figure 13:
Schematic of the
action of the
Picomotor



Slow action of the Picomotor (high static friction) causes the screw to rotate while fast action (low dynamic friction) causes no rotation. By sending pulses with fast rise times and slow fall times, the piezo will rotate the screw counter-clockwise. Similarly, sending pulses with slow rise times and fast fall times rotates the screw clockwise.

Note:

The knob on the end of the drive screw provides inertial mass required for operation. Removal of the knob will prevent the Picomotor from functioning properly and void the warranty.

The Picomotor drivers generate the 130-V pulses required to drive the piezo in the Picomotor.

Step Size and Repeatability

The Picomotor is not a stepper motor. Because it is a friction mechanism, it does not produce identical steps for each input pulse. Although the step size can vary slightly from pulse to pulse, it will always be less than 30 nm for the Standard Picomotor and less than 100 nm for the Tiny Picomotor.

In addition, there will be a significant variance in step size when starting the motor from a standstill or changing its direction.

Other factors that affect the angle change and linear travel per pulse include direction of rotation, load, temperature, and life and wear of the unit.

Picomotor Products and Accessories

There are two important adapters you may need for connecting Picomotor driver modules and motors. The tables below lists the entire Intelligent Picomotor product family, and all of the communication and control ports. The Model 8722 Intelligent Picomotor communication adapter is required for connecting computer RS-232 COM ports to the RS-485 daisy-chained network of the driver modules (see Figure 19 on page 33). The Model 8725 multi-axis adapter connects the 4-pin Picomotor driver outputs to the 6-pin cables provided on multi-axis mount products.

Intelligent Picomotor Modules

Model #	Description	Communication and Control Ports
8750	Intelligent Picomotor Network Controller	2 x RJ-45 (RS-485) 1 x DB-9M (RS-232)
8751-C	Closed-Loop Picomotor Driver	2 x RJ-45 (RS-485) 1 x HDDB-15F (Encoder) 1 x RJ-22 (Actuator)
8752	Intelligent Picomotor Ethernet Controller	2 x RJ-45 (RS-485) 1 x RJ-11 (RS-232) 1 x RJ-45 (Ethernet) 1 x DB-9M (RS-232)
8753	Intelligent Picomotor Driver	2 x RJ-45 (RS-485) 3 x RJ-22 (Actuator)
8754	Intelligent Picomotor Joystick	2 x RJ-45 (RS-485)
8757	Intelligent Picomotor Hand Terminal	1 x RJ-11 (RS-232)
LS-773	Open Collector I/O Module	2 x RJ-45 (RS-485)
LS-784	Open Emitter I/O Module	2 x RJ-45 (RS-485)

Intelligent Picomotor Kits

Model #	Description
8763-KIT	Model 8752 Intelligent Picomotor Ethernet Controller Model 8753 Intelligent Picomotor Driver Model 8755 Driver Kit Power Supply Model 8760 Driver/Controller Assembly Kit

Intelligent Picomotor Accessories

Model #	Description	Connectors
8721	10' Intelligent Picomotor communication cable (RS-232/Ethernet)	2 x RJ-45
8722	Intelligent Picomotor communication adapter (RS-232/RS-485)	1 x DB-9F 1 x RJ-45
8723	3' Intelligent Picomotor communication cable (RS-232/Ethernet)	2 x RJ-45
8724	5" Picomotor communication cable (RS-232/Ethernet) for daisy chaining drivers or other DCN compatible components	2 x RJ-45
8725	Multi-axis adapter (allows use of multi-axis Picomotor devices with Model 8753 driver)	1 x 6-pin RJ-11 3 x 4-pin RJ-22
8726	6" power cable for daisy chaining DCN modules	2 x 2-pin MSTB-2.5/2-ST-5.08
8727	Power connector for connecting user-supplied power	2-pin MSTB-2.5/2-ST-5.08
8729	Intelligent Picomotor Power Cable, Double Pigtail	3 x 2-pin MSTB-2.5/2-ST-5.08
8755	Intelligent Picomotor driver kit power supply	2-pin MSTB-2.5/2-ST-5.08
8760	Intelligent Picomotor Driver/Controller Assembly Kit (contains Models 8724 and 8726 with hardware for daisy chaining)	2 x RJ-45 2 x 2-pin MSTB-2.5/2-ST-5.08

Model #	Description	Connectors
8761	Intelligent Picomotor Computer Interface Kit (contains Model 8721 cable and Model 8722 adapter)	1 x RJ-45 1 x DB-9F

Picomotors

Model #	Description	Connectors
8301–8341	Standard Picomotor	1 x 4-pin RJ-22
8301v–8341v	Vacuum-Compatible Picomotor	Teflon-insulated 28-gauge wires
8351	Tiny Picomotors	1 x 4-pin RJ-22
8310	Closed-loop Picomotor	1 x 4-pin RJ-22 1 x HDDB-15M

Stages and Positioners

Model #	Description	Connectors
8051	Fiber Positioner	1 x 6-pin RJ-11
8071, 8081, 8082	4- and 5-Axis Stages	2 x 6-pin RJ-11
8095	6-Axis Stage	6 x 4-pin RJ-22
8401	Rotary Stage	1 x 4-pin RJ-22

Optical Mounts

Model #	Description	Connectors
8807	Mirror Mount	2 x 4-pin RJ-22
8808–8854	Mirror Mounts	1 x 6-pin RJ-11
888X	Pint-Sized Mounts	2 x 4-pin RJ-22

Software Options

As described in the next chapter, the Intelligent Picomotor network can be set up for manual control using the stand-alone driver kits and hand terminal or joystick, for computer control, or for a custom configuration using some combination of both. New Focus offers several software utilities and applications that can help you create the appropriate system to suit your motion control needs. These software options and their requirements are described below.

Distributed Control Network (DCN) Utility

Description: Set-up and diagnostic utility

Type: Stand-alone Windows-based application

Hardware Supported/Required: Models 8753 and 8751-C driver(s), Model 8754 joystick, Model 8761 PC Interface Kit

Motion Control Language (MCL)

Description: Set of host commands for accessing the MCL firmware in the network controller.

Type: Serial port command interpreter that can be accessed using HyperTerminal/MCC Terminal, LabVIEW, C++, or Visual Basic

Hardware Supported/Required: Model 8750 Network Controller, Model 8752 Ethernet Controller, Null modem cable, Model 8757 Hand Terminal

Dynamic Link Library (DLL) Library

Description: Function library file to support custom low-level programming

Type: Programming library that can be accessed using LabVIEW, C++, or Visual Basic

Hardware Supported/Required: All Intelligent Picomotor modules, Model 8761 PC Interface Kit

User Safety



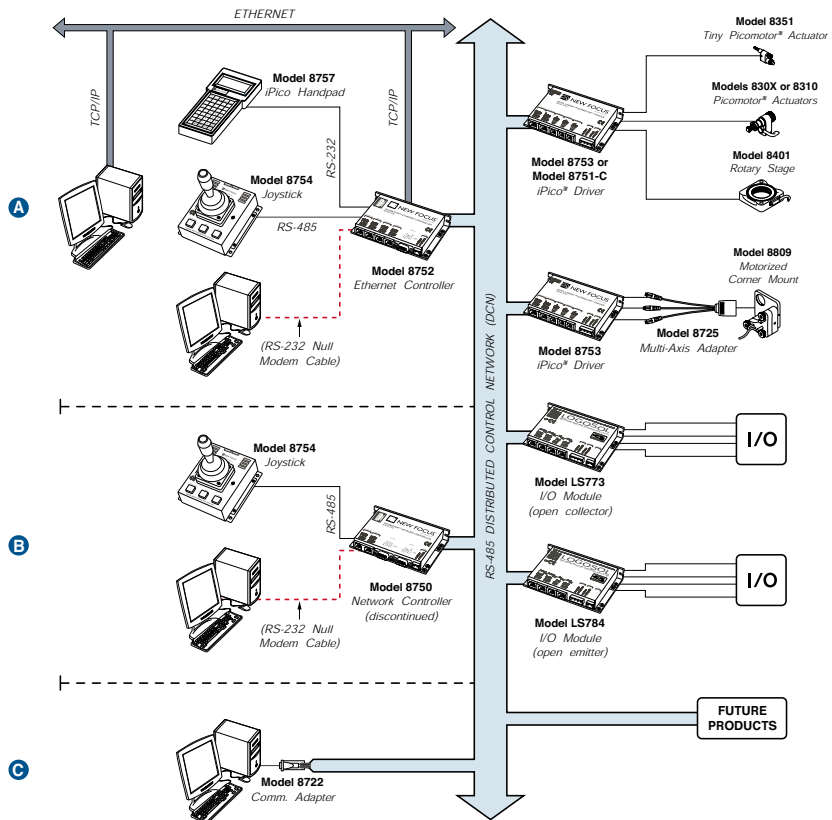
Voltages of up to 130 V are accessible inside the driver chassis, mounts, and Picomotors. Although protection circuits are included, *do not* operate the units with the driver or mount covers removed. If the wire of a mount or Picomotor is frayed, discontinue use and return it for repair.

Setting Up

Overview

The Intelligent Picomotor components—including the Models 8753 and 8751-C drivers, the Models LS-773 and LS-784 I/O modules, the Model 8750 network controller, the Model 8752 Ethernet controller, the Model 8754 joystick, and the Model 8757 hand terminal—are a part of a versatile and powerful platform for motion control. Depending upon your unique application, the Intelligent Picomotor network can be set up with the network controller, utilizing its embedded MCL firmware for manual or computer control, it can be set up with the Ethernet controller for control with a hand terminal or computer via the Ethernet, it can be connected to the serial port of a PC to directly control the drivers and joystick via DLL functions or the DCN Utility, or it can be set up using any number of combinations of the above. Figure 14 gives an overview of the configuration options.

Figure 14: Motion control using the Intelligent Picomotor network



Based on your chosen application, the Intelligent Picomotor network can be set up for use in one of many ways:

- Manual control using a driver kit and selected interface peripheral (joystick, hand terminal, computer)
- Computer control using MCL with the network controller
- Computer control using MCL with the Ethernet controller
- Hand terminal control using MCL with the Ethernet controller
- Mixed control using MCL with a Serial Port and PC, hand terminal, and/or joystick and Ethernet controller
- Computer control using DLL/DCN with the driver(s) only
- Computer control using DLL/DCN with the driver(s) and I/O module(s)

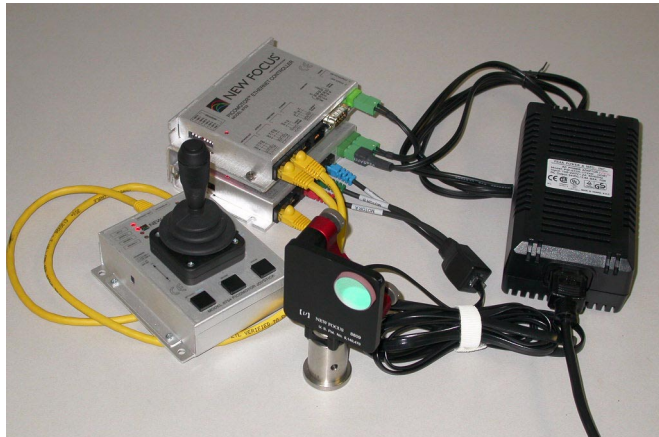
- Computer control using DLL/DCN with the driver(s) and joystick
- Computer control using DLL/DCN with the Driver(s) and I/O Modules

The following sections describe the different set-up methods and the steps needed to get your system up and running.

Driver Kits with Joystick and/or Hand Terminal

The Model 8763-KIT driver kit, when configured with a joystick or hand terminal, is an out-of-the-box solution for manual motion control, or for computer control, with the addition of an optional Model 8761. The kits come pre-assembled, with the Ethernet controller and driver mounted together, and include all of the cables and adapters needed for connecting the controller, driver, and power supply. A common hardware configuration for the Model 8763-KIT is shown in Figure 15.

Figure 15:
Model 8763-KIT
with joystick and
mount



The following section takes you through the basic steps for connecting the components of the kit and a joystick or hand terminal. The controls and functions are described in the “Manual Control: Using the Hand Terminal or Joystick” chapter beginning on page 37.

1. Connect the Model 8752 Ethernet Controller’s **Network Out** port to the Model 8753 driver’s **Network In** using a 5' communication cable (Model 8724).

2. On the last driver or module in any RS-485 network, set the two terminating resistors' DIP switches to the "ON" position.
3. If you will be using a Model 8754 Joystick in your set-up:
 - Connect the Ethernet controller's **Joystick** port to the joystick's **Network In** using a Model 8723 communication cable.
 - Verify that the joystick's DIP switches are set to their default positions: **SW1** is "OFF" and **SW2** is "ON."
4. To connect a Model 8757 Hand Terminal, plug it into the **Hand Terminal** port using the cable provided with the hand terminal.
5. Connect the controller's power supply connector to the driver's power connector using the Model 8726 power supply cable. Be sure to place the power supply cable connector into the right two pins in the driver.
6. Connect the controller's Ethernet port to your network using a standard Category 5 cable.

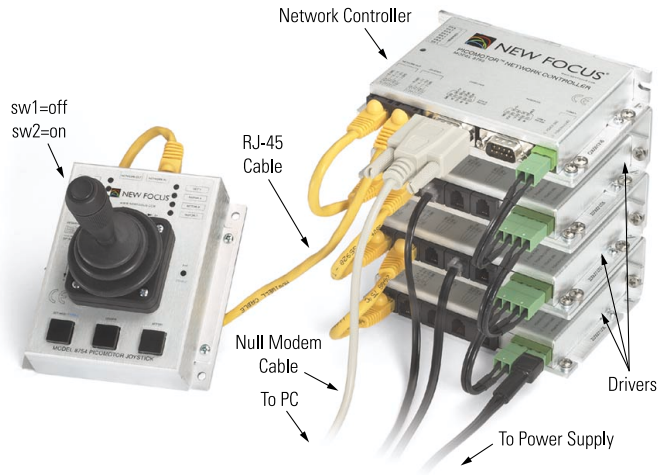
Using MCL with the Network Controller

The MCL firmware for the New Focus network controller contains a simple but powerful set of host commands that can be used to integrate the network controllers into your custom applications. The MCL commands are described in the "Computer Control: Using MCL" chapter beginning on page 45.

To access the MCL commands, set up your network as described below. Then, using a standard DB-9 NULL-Modem RS-232 cable, connect the **COM** port of your host computer to the **Computer** connector on the network controller. The baud rate should be set to 19200; there are eight data bits, one stop bit, and no parity.

Figure 16 shows the hardware configuration for using MCL with the network controller.

Figure 16:
Hardware
configuration for
using MCL with the
Network Controller



The following section takes you through the basic steps for setting up a system with the Model 8750 Network Controller.

1. Connect the network controller's **Network Out** port to the Model 8753 driver's **Network In** using a 5" communication cable (Model 8724).
2. If you are using more than one driver, connect the **Network Out** from the first driver to the **Network In** on the next driver using another 5" communication cable.
3. Repeat Step 2 for all remaining drivers.
4. If you are using LS-773 or LS -784 I/O module(s) in your set-up, connect the **Network In** from the first I/O module to the **Network Out** on the last driver (see Figure 20).

Note: *I/O modules must be connected to the end of the daisy chain of devices, after the drivers.*

5. For the last driver or I/O module on the network, set the two terminating resistors' DIP switches to the "ON" position.
6. If you are using a joystick in your setup:

Note:

- Connect the network controller's Joystick port to the joystick's Network In using a Model 8723 communication cable.
The joystick can actually be hooked up to either network port on the controller, not just the Joystick port.
 - Verify that the joystick's DIP switches are set to their default positions: SW1 is "OFF" and SW2 is "ON."
7. Connect the controller's power supply connector to the first driver's power connector using the Model 8726 power supply cable. Be sure to place the power supply cable connector into the right two pins in the driver.
 8. If you are using more than one driver, use the additional Model 8726 power cables to connect power. Align the cables such that the connected pins from the adjacent drivers match, i.e., if the cable comes from the right pins it plugs in to the right pins of the next driver, then the next cable goes out from the left pins and plugs into the left pins of the next connector, and so on (see Figure 16).
 9. If you are using I/O modules in your setup, place the center terminal of the 8729 split power cable into the driver adjacent to the I/O module. Connect one end of the cable to the I/O module power input pins 1 and 2. Connect the other end to the next driver in the stack or to the network controller if this is the only driver.
 10. Connect the power supply to the remaining power input on the last driver in the chain (i.e., the driver furthest away from the controller).

Note:

Each power supply supports up to three drivers. If you have more than three drivers in your installation, you will need to hook in additional power.

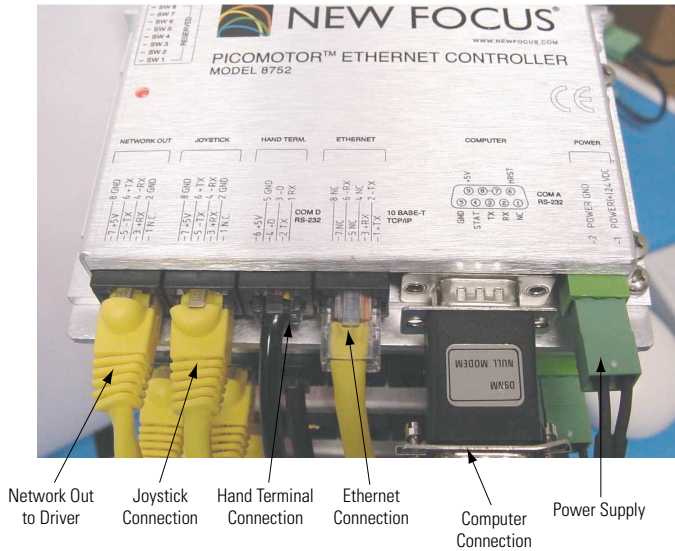
Using MCL with the Ethernet Controller

The Model 8752 Intelligent Picomotor Ethernet Controller can be used to interface a computer with up to 31 drivers and/or I/O modules using a standard TCP/IP Ethernet interface. It can also be set up for use with the Model 8757 Hand Terminal and Model 8754 Joystick, or for computer control using the RS-232 serial interface, as described in the "Using MCL with the Ethernet Controller and Hand Terminal" and

“Using MCL with a Serial Port and PC, Hand Terminal, Joystick, and/or Ethernet Controller” sections below.

Figure 17 shows the various set-up connections available when using MCL with the Ethernet controller.

Figure 17: Model 8752 Ethernet Controller with set-up connections



The following section takes you through the basic steps for setting up a system with the Model 8752 Ethernet Controller. The controls and functions are described in the “Computer Control: Using MCL” chapter beginning on page 45.

1. Connect the Model 8752 Ethernet Controller’s **Network Out** port to a Model 8753 or Model 8751-C driver’s **Network In** using a 5" communication cable (Model 8724).
2. If you are using more than one driver, connect the **Network Out** from the first driver to the **Network In** on the next driver using another 5" communication cable.
3. Repeat Step 2 for all remaining drivers.

4. If you are using LS-773 or LS -784 I/O module(s) in your set-up, connect the **Network In** from the first I/O module to the **Network Out** on the last driver (see Figure 20).

Note:

I/O modules must be connected to the end of the daisy chain of devices, after the drivers.

5. For the last driver or I/O module on the network, set the two terminating resistors' DIP switches to the "ON" position.
6. If you will be using a Model 8754 Joystick in your set-up:
 - Connect the Ethernet controller's **Joystick** port to the joystick's **Network In** using a Model 8723 communication cable.
 - Verify that the joystick's DIP switches are set to their default positions: **SW1** is "OFF" and **SW2** is "ON."
7. Connect the controller's power supply connector to the first driver's power connector using the Model 8726 power supply cable. Be sure to place the power supply cable connector into the right two pins in the driver.
8. If you are using more than one driver, use the additional Model 8726 power cables to connect power. Align the cables such that the connected pins from the adjacent drivers match, i.e., if the cable comes from the right pins it plugs in to the right pins of the next driver, then the next cable goes out from the left pins and plugs into the left pins of the next connector, and so on (see Figure 17).
9. Connect the power supply to the remaining power input on the last driver in the chain (i.e., the driver furthest away from the controller).

Note:

Each power supply supports up to three drivers. If you have more than three drivers in your installation, you will need to hook in additional power.

10. If you are using I/O modules in your setup, place the center terminal of the 8729 split power cable into the driver adjacent to the I/O module. Connect one end of the cable to the I/O module power input pins 1 and 2. Connect the other end to the next driver in the stack or to the network controller if this is the only driver.

11. Connect the controller's Ethernet port to your network using a standard Category 5 cable.

Note:

Ethernet configuration and communication options are described in detail in the “Using the Ethernet” section beginning on page 48.

Using MCL with the Ethernet Controller and Hand Terminal

The Model 8757 Hand Terminal provides additional manual control capabilities to the Intelligent Picomotor system—it can control up to 31 drivers, compared to just three drivers with the joystick. The controls and functions are described in the “Manual Control: Using the Hand Terminal or Joystick” chapter beginning on page 37.

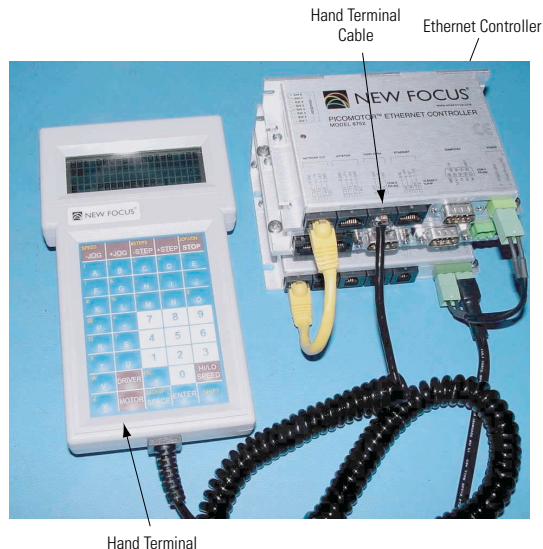
To using a hand terminal for manual control, set up your network as described in the “Using MCL with the Ethernet Controller” section above. Then, simply connect the hand controller to the **Hand Terminal** port using the cable provided with the hand terminal.

Note:

The hand terminal can be hot-plugged into the network and used immediately.

Figure 18 shows a typical hardware configuration using the hand terminal.

Figure 18: Model 8757 Hand Terminal connected to Model 8752 Ethernet Controller



Using MCL with a Serial Port and PC, Hand Terminal, Joystick, and/or Ethernet Controller

The Intelligent Picomotor drivers and I/O modules can be controlled in any number of ways: with a joystick, a hand terminal, an Ethernet controller connected through Ethernet, a PC connected to the serial port, or a combination of two these methods simultaneously. For example, while directing a device with the hand terminal, you can use a PC connected to a serial port to monitor the motion its motion.

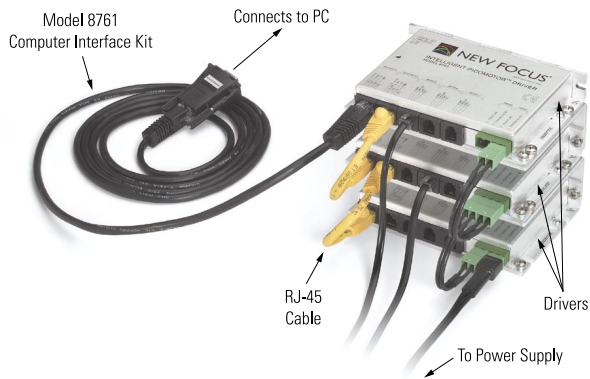
To set up your network for multiple methods of control using the Ethernet Controller, follow the steps described in “Using MCL with the Ethernet Controller” (and “Using MCL with the Ethernet Controller and Hand Terminal” if you are using a hand terminal). Then, using a standard DB-9 NULL-Modem RS-232 cable, connect the **COM** port of your host computer to the **Computer** connector on the network controller. The baud rate should be set to 19200; there are eight data bits, one stop bit, and no parity.

Figure 17 shows the possible set-up connections for using MCL with the Ethernet controller.

Using DLL/DCN with the Driver(s) Only

For computer control of the drivers using the available DLL library (page 115) or DCN Utility (page 101), you will need to build your system without using the network or Ethernet controllers. The hardware configuration is shown in Figure 19.

Figure 19:
Hardware
configuration for
using DLL/DCN
with driver(s) Only



1. Use the Model 8761 Computer Interface Kit to connect the **Network In** port of the driver to the computer's **COM** port.
2. If you are using more than one driver, connect the **Network Out** port of the first driver to the **Network In** on the next driver using the Model 8724 communication cable.
3. Repeat Step 2 for all remaining drivers.
4. For the last driver on the network, set the two termination resistors' DIP switches to the "ON" position.
5. Connect the Model 8755 power supply to the driver's power connector.
6. If you are using more than one driver, connect the power supply to the last driver on the network and daisy chain adjacent drivers with the Model 8726 power cable. Align the cables such that the connected pins from the adjacent drivers match, i.e., if the cable comes from the right pins it plugs in to the right pins of the next driver, then the next cable goes out from the left pins and plugs into the left pins of the next connector, and so on (see Figure 19).

Note:

Each power supply supports up to three drivers. If you have more than three drivers in your installation, you will need to hook in additional power.

Using DLL/DCN with the Driver(s) and I/O Module(s)

To set up for computer control of the driver and I/O modules using the available DLL library (page 115) or DCN Utility (page 101), follow steps 1–3 in the “Using DLL/DCN with the Driver(s) Only” section above. Then take the following steps:

1. Connect the **Network In** from the first I/O module to the **Network Out** on the last driver.

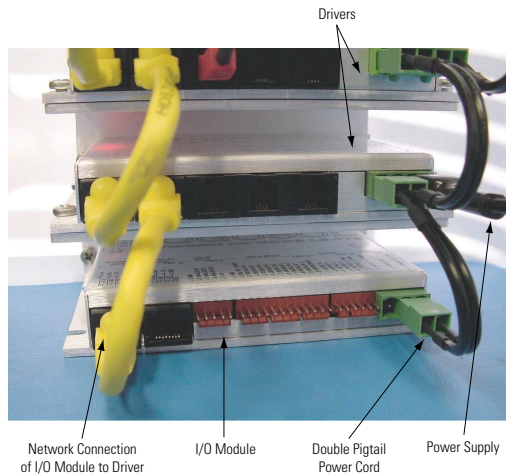
Note:

I/O modules must be connected to the end of the daisy chain of devices, after the drivers.

2. For the last I/O module on the network, set the two terminating resistors’ DIP switches to the “ON” position.
3. Place the center terminal of the 8729 split power cable into the driver adjacent to the I/O module. Connect one end of the cable to the I/O module power input pins 1 and 2. Connect the other end to the next driver in the stack.

The hardware configuration is shown in Figure 20.

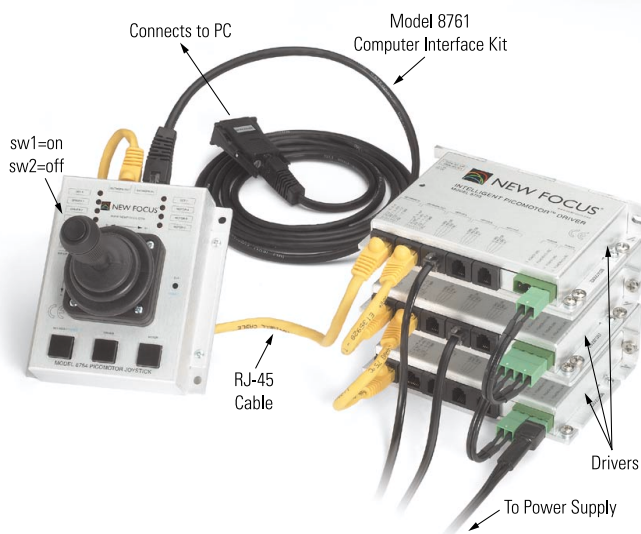
Figure 20: Model LS-773 or LS-784 connected to iPico drivers



Using DLL/DCN with the Driver(s), I/O Module(s), and Joystick

The DLL library (page 115) and DCN Utility (page 101) also include commands for the joystick. To utilize them, you will need to build your system without using a network controller. The hardware configuration is shown in Figure 21.

Figure 21:
Hardware
Configuration for
Using DLL/DCN
with Driver(s) and
Joystick



1. Set the DIP switches on the joystick as follows: SW1 is “ON” and SW2 is “OFF.”
2. Use the Model 8761 computer interface kit to connect the **Network In** port of the joystick to the computer’s **COM** port.
3. Connect the **Network Out** port of the joystick to the **Network In** port of the driver using a Model 8723 communication cable.
4. If you are using more than one driver, connect the **Network Out** port of the first driver to the **Network In** on the next driver using the Model 8724 communication cable.
5. Repeat Step 2 for all remaining drivers.

6. If you are using LS-773 or LS -784 I/O module(s) in your set-up, connect the **Network In** from the first I/O module to the **Network Out** on the last driver (see Figure 20).

Note:

I/O modules must be connected to the end of the daisy chain of devices, after the drivers.

7. For the last driver or I/O module on the network, set the two termination resistors' DIP switches to the "ON" position.
8. Connect the Model 8755 power supply to the power connector on the driver.
9. If you are using more than one driver, connect the power supply to the last driver on the network and daisy chain adjacent drivers with the Model 8726 power cable. Align the cables such that the connected pins from the adjacent drivers match, i.e., if the cable comes from the right pins it plugs in to the right pins of the next driver, then the next cable goes out from the left pins and plugs into the left pins of the next connector, and so on (see Figure 21).
10. If you are using I/O modules in your setup, place the center terminal of the 8729 split power cable into the driver adjacent to the I/O module. Connect one end of the cable to the I/O module power input pins 1 and 2. Connect the other end to the next driver in the stack.

Note:

Each power supply supports up to three drivers. If you have more than three drivers in your installation, you will need to hook in additional power.

Manual Control: Using the Hand Terminal or Joystick

Overview

The Model 8757 hand terminal and Model 8754 joystick offer two alternatives for manual control of a Picomotor network.

The joystick, when used with the Model 8750 network controller, can control up to three Model 8753 and/or Model 8751-C drivers (nine standard or three closed-loop Picomotors).

The hand terminal, an ASCII terminal for use with the Model 8752 Ethernet Controller, offers even greater control functionality. The terminal provides preprogrammed shortcut keys for simple Picomotor control, or users can type in individual MCL commands directly using its standard keypad and alphanumeric display.

Using the Hand Terminal

Display

The Model 8757 Hand Terminal has a 45-key keypad for executing commands, programming, or local control of the Picomotors with shortcut keys. The first row of the LCD display shows the status of the network components (see Status Indicators section below). The second line is used as a “command line” to display the command typed by the user or selected from the shortcut keys. The third and fourth lines show the response from the controller.

Status Indicators

- **HH:** The hand terminal is active.
- **DRV=x:** The hand terminal has selected driver x for control.
- **MOT=y:** The hand terminal has selected motor y for control.
- **S/s:** The selected motor is a closed-loop motor and is in closed-loop mode/open-loop mode (toggle with **SER/NOS** shortcut key).
- **J/j:** The joystick is active/inactive (toggle with **JOF/JON** shortcut key).
- **C/F/U:** The selected axis is set to coarse speed/fine speed/user-defined speed.
- **T/t:** A telnet session is active/inactive.
- **MAP:** The joystick is active and is remapped according to the list of joystick axes corresponding to listed drivers.

Shortcut Keys

The hand terminal features shortcut keys which allow the user to perform preprogrammed functions without the need to key in a series of MCL commands. Each key is assigned two functions, as printed in white and yellow on the button. A single key press will perform the function printed in white; pressing the **Shift** key then the key will command the function in yellow.

Note:

The shortcut keys are applicable to one axis only (the currently selected driver and channel).

The shortcut keys and their functions are as follows:

- **Steps**—Defines the number of pulses sent to the selected channel when a +/- Step is invoked. The default value is 1. Press **Shift** then **Step** keys to activate.
- **Hi/Lo**—Toggles between Coarse (2000 Hz) and Fine (250 Hz) speeds. The default setting is Fine. Press **Shift** then **Hi/Lo** key to activate.
- **+Jog**—Sends continuous positive step count to the selected axis at the selected Velocity as long as button is pressed. The motion mode is Velocity mode.
- **-Jog**—Sends continuous negative step count to the selected axis at the selected Velocity as long as button is pressed. The motion mode is Velocity mode.

- **SER/NOS**—Toggles open-loop/closed-loop control mode of active 8751-C driver (displayed as s or S on status line). Press **Shift** then **+Step** to activate.
- **+Step**—Sends X positive steps to the selected axis at the selected speed. The motion mode is Position mode.
- **-Step**—Sends X positive steps to the selected axis at the selected speed. The motion mode is Position mode.
- **Stop**—Aborts current motion (stop abruptly).
- **Driver**—Selects which drive module is associated with the shortcut keys. To activate, press this key followed by a number indicating the address of the drive module, and then press **Enter** to complete the command.
- **Motor**—Selects which motor channel is associated with the shortcut keys. This will toggle between the three motor channels; the user will not need to type in a number to select the channel. In addition, this command will automatically enable the driver amplifier. If the user presses this key again to toggle to another channel, the amplifier will be disabled, the channel changed, and then the amplifier re-enabled.
- **Jof/Jon**—Enables/disables the joystick (toggle). Press **Shift** then **Jof/Jon** key to activate.
- **Speed**—This lets the user set a specific speed, if a speed different than that set with the Coarse/Fine speed toggle. Press **Speed**, enter a number indicating the speed (in Hz), then press **Enter** to complete the command.

Using the Joystick

Control Modes

The network controller contains firmware that allows you to control the Picomotor drivers in three modes:

- **Stand-alone mode:** The joystick controls the motors on up to three drivers.
- **Edit mode:** The joystick controls the motors on up to three drivers, selected from the entire network of up to 31 drivers, with

additional parameters edited using the MCL computer interface (see page 45).

- **Command mode:** The joystick is disabled, and the MCL computer interface controls the motors on up to 31 drivers (see page 45). When the network is switched to command mode, all of the LEDs on the joystick will be illuminated.

Rules of Operation

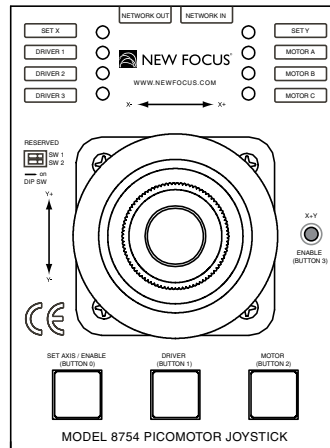
When setting up and using the joystick, it is important to note the following:

- A peripheral device, either joystick, hand terminal, or computer, must be present at power-up for the network controller to function. An LED will flash on the network controller to indicate when there is no properly connected peripheral.
- Once the network is initialized, the joystick can be unplugged and replugged into the network. Note that when the joystick is replugged into the network, it does a reset, loads saved values, and goes into stand-alone mode automatically.
- The network controller has a battery backed-up RAM which is normally enabled (see “Network Controller DIP Switches” on page 210.) This allows the joystick settings (I/O states) to stay in memory when the system is powered off.
- Drivers can also be unplugged and replugged into the network, but the driver and channel settings are set to default whenever this is done. The network should be reset after adding or removing a driver.
- The joystick can only control three of the 31 possible drivers in a system with one controller. By default, the joystick will only be able to access only the first three drivers in the network. However, the joystick can be set to operate any three drivers in the network using the `Map` command under computer control (see “Computer Control: Using MCL” on page 45).
- Changes made to parameters in edit mode stay current until a power cycle or initialization reloads the “saved” values. To make any change permanent, parameters must be saved (page 65).
- The default control mode after power-up or reset is stand-alone.

- The joystick has four buttons that can be used, in various combinations, to manually control the network functions (see Figure 22):
 - **Set Axis Enable** (Button 0)
 - **Driver** (Button 1)
 - **Motor** (Button 2)
 - **X+Y Enable** (Button 3)
- Pressing the **Set/Axis Enable**, **Driver**, and **Motor** buttons on the joystick will reset the network and load the saved parameters. This will work even when the joystick is turned off by a JOF MCL command.
- Pressing the **Set/Axis Enable**, **Motor**, and **X+Y/Enable** buttons on the joystick will reset the network and load the default parameters. This will work even when the joystick is turned off by a JOF MCL command.

Selecting the Motors to Control

Figure 22:
Top view of Model
8754 joystick



The Model 8754 is a two-axis joystick that can control up to nine Picomotors. By default, the X axis and Y axis will be set to the first and second motor ports on Driver 1. Use the buttons on the joystick to change the assignment of motors to the X axis and Y axis of the joystick.

1. Press the **Set Axis/Enable** button to select which axis you want to change. The Set X and Set Y LEDs at the top of the joystick will indicate which axis is open for programming.

You can prevent accidental changes to joystick settings by pressing **Set Axis/Enable** until the Set X and Set Y LEDs blink alternately. In this locked state, the X and Y axis maps are displayed in alternation.

2. Press the **Driver** button to select a driver for the axis. The Driver 1, Driver 2, and Driver 3 LEDs will indicate the active driver.

The driver numbers represent the order in which the drivers are connected to the Network Controller, with Driver 1 being the one directly connected to the controller.

The driver map can be changed to allow the joystick to control any driver in the network through the MAP command in MCL.

3. Press the **Motor** button to assign a different motor of the selected driver to the axis. The Motor A, Motor B, and Motor C LEDs will indicate the selected axis. You will not be able to assign the same driver and motor to both the X and Y axes of the joystick. If the selected driver is an 8751-C closed-loop driver, the selections Motor B and Motor C are disabled.

To disable an axis, press the **Motor** button until all three motor LEDs are off.



By default, the network controller firmware is set to control Standard Picomotors. If you have selected any Tiny Picomotors to control, you must change the motor type settings using MCL commands (see “Set Motor Type” on page 86) before using the joystick. A Picomotor can be damaged if it is driven with the wrong type of driver signal for an extended period of time, so it is important to ensure that the motor driver is configured to generate the correct driver signals.

Controlling Picomotors

Once you have assigned motors to the joystick, moving the joystick handle will run the selected motors.

- For the X axis, moving the joystick left of center will move the Picomotor counter-clockwise or backwards; right of center results in clockwise or forward motion.
- For the Y axis, moving the joystick above center will move the Picomotor clockwise or forward; below center results in counter-clockwise or backward motion.

Fine/Coarse Speed

The joystick provides the user with two speed ranges: “coarse speed,” with a speed range of 8 Hz to 2000 Hz, and “fine speed,” with a speed range of 1 Hz to 250 Hz. In addition, both the “coarse speed” and the “fine speed” ranges will have logarithmic responses.

The speed setting will affect both active channels (X and Y) on the joystick and will also be saved so that the user-selected range is retained during a power cycle. The default setting for the joystick is “coarse speed.” The fine/coarse adjustment can be done from the joystick by pressing the **Driver** and **X+Y Enable** buttons (if joystick is not locked out and/or in axis-selection mode).

Setting Velocity and Acceleration Parameters

Using the Motion Control Language (MCL), you can set parameters that will allow better control over your motorized devices. Although the drivers support a maximum speed of 2 kHz, you can use MCL to set minimum velocity, maximum velocity, and acceleration—see “Computer Control: Using MCL” on page 45. The joystick will automatically use these settings.

For example, to reconfigure the joystick for “extra fine” speed control (e.g., 1 Hz to 10 Hz), the velocity of the particular channel needs to be changed and saved (to make the change permanent). See the MCL “Example 3” on page 100.

You can use the joystick to reset the velocity, acceleration, and speed factor parameters:

- Press the **Set Axis/Enable**, **Driver**, and **Motor** buttons simultaneously to revert to the last saved parameters.
- Press the **Set Axis/Enable**, **Driver**, and **X+Y/Enable** buttons simultaneously to revert to the factory default parameters (maximum velocity = 2 kHz, minimum velocity = 8 Hz, and acceleration = 8 steps/s²).

Moving Two Motors Simultaneously

Although each driver can only drive one Picomotor at a time, the joystick does support driving two Picomotors simultaneously, as long as they are attached to different drivers.

1. Assign the X axis and Y axis of the joystick to Picomotors on different drivers. (See “Selecting the Motors to Control” on page 41.)
2. Press and hold the **X+Y/Enable** button on top of the joystick to move the two motors simultaneously.
3. Release the **X+Y/Enable** button to move just one axis.

Enabling/Disabling the Joystick

You can disable the joystick to prevent accidentally changing the position of Picomotors or of joystick settings. To enable or disable the joystick:

1. Press and hold the **Set Axis/Enable** button. While this button is held down, moving the joystick will not move any Picomotors.
2. Press and release the **X+Y/Enable** button on the top of the joystick.
3. Release the **Set Axis/Enable** button.
4. While the joystick is disabled, all three driver LEDs will be illuminated on the joystick.

Communications Lock-out

Because the Model 8750 network controllers and Model 8752 Ethernet controllers accept input from multiple sources, it can be important to lock out unwanted communication ports. When lock/unlock from joystick is engaged, communication from all the other ports (PC serial, handpad serial, and Ethernet) on the controller will be disabled, and the controller will only respond to commands from the joystick. The hand terminal displays a message `Locked` or `Unlocked`, and input of commands from the terminal is suspended or resumed, respectively. Serial console and Telnet sessions will still accept commands, but they will return an error `LOCKED` when commands are submitted.

The lock-out from the joystick is achieved by pressing the **Motor** and **X+Y Enable** buttons (if joystick is not locked out and/or in axis-selection mode). Pressing the **Motor** and **X+Y Enable** buttons again will toggle the mode, and communication from all other ports will be enabled. The default mode is with all ports enabled.

Computer Control: Using MCL

Overview

The MCL firmware for the New Focus Model 8750 Network Controller and Model 8752 Ethernet Controller contains a simple but powerful set of host commands. The network controller firmware supports up to 31 Picomotor drivers and a joystick; it can be controlled either manually with the joystick or through MCL with a computer connected to the serial port. The Ethernet controller supports up to 31 drivers and/or I/O modules, a joystick, and a hand terminal; it can be controlled manually with the joystick or hand terminal or through MCL with the hand terminal or a computer connected via the serial port or Ethernet.

The communication protocol is strictly master-slave protocol—the host sends a command to the controller and receives the answer. An answer can be either success or failure.

Both controllers maintain two sets of operational parameters—default parameters and non-volatile (Flash) parameters. On power up, the firmware will load the Flash parameters. MCL lets you override the existing firmware or save new values for various parameters.

Using the RS-232 Interface

The host computer can communicate serially with both the network controller and the Ethernet controller using a standard DB-9 NULL-Modem RS-232 cable connected to the **Computer** connector on the controller. The baud rate should be set to 19200; there are eight data bits, one stop bit, and no parity.

The first driver should be connected to the **Network Out** connector. The I/O modules should be connected to the last driver in the daisy chain. The joystick should be connected to the **Joystick** connector.

Note:

See “Using MCL with the Network Controller” on page 26 or “Using MCL with the Ethernet Controller” on page 28 for hardware set-up instructions.

Software Set-Up

MCL commands can be sent to the controller either by using a standard Windows Hyperterminal and manually typing in individual commands or by using custom programs like LabVIEW™, C/C++, or Visual Basic® to send sequences of commands.

Hyperterminal Settings

To set up Windows Hyperterminal for communication with the controller, you will need to take the following steps:

1. Open a Hyperterminal session.
2. Under the **File** menu, select **Properties**.
3. In the **Connect To** tab, select the proper serial port from the “Connect using” list box.
4. Click the **Configure** button and set the following parameters:

Bits per second	19200
Data bits	8
Parity	NONE
Stop Bits	1
Flow control	NONE

5. Close the Port settings window by clicking **OK**.
6. Select the **Settings** tab.
7. Verify the following settings:

Emulation	AUTODETECT
Backscroll buffer lines	500

8. Click the **ASCII Setup** button.
9. Set the following parameters:
Echo typed characters locally
Append line feeds to incoming line ends

All other check boxes should not be selected.

10. Close the ASCII Setup window by clicking **OK**.

11. Close the Properties window by clicking **OK**.

Note:

You may experience problems with line feeds in some versions of Hyperterminal. Alternate software is available by download from the New Focus website; see the Network Controller Terminal section below.

Network Controller Terminal

A stand-alone program for communicating with the MCL firmware, called Network Controller Terminal, can be downloaded from the New Focus web site. Network Controller Terminal functions like a Windows Hyperterminal and can be used to send individual MCL commands via a serial port to the network controller or Ethernet controller.

To use Network Controller Terminal:

- 1.** Hook up the network controller or Ethernet controller to the **COM** port of your PC using a NULL-modem cable.
- 2.** Start the Network Controller Terminal program.
- 3.** Verify the “COM port” setting matches the hardware connection. “COM1” is the default setting.
- 4.** Press the **Initialize** button. If initialization is successful, the “Command” text field will change from gray (inactive) to white (active).
If initialization is not successful, check that your hardware connections, cable type, and COM port settings are correct. See “Using MCL with the Network Controller” on page 26 for more information.
- 5.** To use the software, type commands into the “Command” text field and press **Send**. Responses will appear in the “Terminal window.”

Using the Ethernet

Ethernet Communication Options

The Model 8752 Ethernet Controller offers fully integrated 10Base-T Ethernet connectivity over TCP protocol. Dynamic Host Configuration Protocol (DHCP) and Domain Name Service (DNS) are supported configuration options, and Telnet and HTTP are supported application protocols (other protocols including FTP, SMTP, etc. are not implemented). MCL commands can be sent through TCP/IP using standard Telnet client communication.

TCP/IP Communication Applications

TCP/IP-based communication, using MCL commands, can be initiated in several ways:

- Using a standard Windows® Telnet Terminal client.
- Using programming environments such as C/C++, Visual Basic®, LabVIEW™, etc. and using TCP Port 23 to establish a Telnet client interface.

Ethernet Configuration Options

The Model 8752 Ethernet Controller can be configured in a variety of standard ways, depending upon the network environment available:

- **Default configuration:** The default factory-set Ethernet configuration uses DHCP to establish current TCP/IP parameters upon power-up or reset. The default host name is NF8752-xxxxxx, where “xxxxxx” is the last three bytes of the unique Media Access Control (MAC) address of the controller. As such, the default host name is always unique, and the controller can get different network configuration parameters (IP address, network mask, gateway, and name-server addresses) from a DHCP server on the user’s network each time it powers-up or resets. This is the recommended option for users who have networks with DHCP and Dynamic DNS (DDNS) servers.

- **Custom DHCP configuration with reserved IP address:** To circumvent the problem of getting different IP addresses from the DHCP server, a specific IP address linked to the controller's MAC address can be reserved within the DHCP server on the user's network by the network administrator. This will ensure that the controller gets assigned the same IP address every time. This is the recommended option for users who have networks with DHCP servers, but no DDNS servers.
- **Custom static configuration:** Users can also choose to manually assign a fixed IP address to the controller. However, in order to avoid network conflicts, the fixed IP address needs to be blocked from being assigned to other network devices by the network administrator. In addition to the IP address, the IPMode, Default Gateway, and Netmask also need to be manually configured.

Activating Configuration Changes

If any of the network parameters are changed, they must be *SAVED* to the non-volatile memory and the controller restarted in order for the settings to come into effect. The network settings can be changed from any of the three ports—computer, hand terminal, or Ethernet.

Name Resolution

For name resolution requests from clients, it is the network administrator's responsibility to ensure that the host name and IP address of the controller are registered, either automatically with a DDNS server or manually with a Static DNS server, if either one of these exist on the user's network. It is also possible to implement name resolution locally on a single computer using the standard Windows "hosts" (or equivalent) file.

Reverting Back to Factory Default Configuration

If any network configuration changes cause the Ethernet connectivity of the controller to stop functioning, the user can revert back to the factory default IP configuration by flipping up DIP Switch #1 and doing a reset using the **Set/Axis Enable**, **Motor** and **X+Y Enable** buttons on the joystick. After the initialization is complete, turn back down DIP

Switch #1 and execute a `SAV` command to save the network configuration parameters to NVRAM.

Ethernet Configuration Examples

Ethernet Configuration Example 1

The Ethernet controller is to be used with the default configuration in a network that has a DHCP server but no DNS server.

To initiate TCP/IP based communication with the controller, the user will need take the following steps:

1. Power-up the controller. It will auto-configure itself with DHCP and default host name.
2. Send an `IPADDR MCL` command serially via the hand terminal or computer port to get the current IP address of the controller.
3. Confirm that the Ethernet connection is working by doing one or more of the following:
 - Type `Ping <ipaddr>` at the MS-DOS prompt from a workstation connected to the same network as controller.
 - Open up a browser (Internet Explorer or Netscape) and type in `<ipaddr>` to access the web page. Verify the current network configuration displayed on the web page.
 - Type `Telnet <ipaddr>` at the MS-DOS prompt.

Ethernet Configuration Example 2

The Ethernet controller is to be used with the default configuration in a network with DHCP and DDNS servers (e.g. Win2000 Server). However, the host name needs to be changed to NF8752-001.

The user will need to go through the following steps:

1. Power-up the controller. It will auto-configure itself with DHCP and default host name.
2. Change the host name to `HOSTNAME NF8752-001`.
3. Save the configuration by issuing a `SAV` command.

4. Restart by pressing the **Set/Axis Enable**, **Motor** and **X+Y Enable** buttons on the joystick, sending a `Reset MCL` command from any port, or doing a power-cycle.

After initialization is complete, confirm that the Ethernet connection is working by doing one or more of the following:

- Type `Ping NF8752-001` at the MS-DOS prompt from a workstation connected to the same network as controller. Verify that the IP address is resolved to the controller's IP address. You can check the controller's IP address by issuing the `IPADDR` command from a handpad or Computer port.
- Open up a browser (Internet Explorer or Netscape) and type in `NF8752-001` to access the web page. Verify the current network configuration displayed on the web page.
- Type `Telnet NF8752-001` at the MS-DOS prompt.

Ethernet Configuration Example 3

The Ethernet controller is to be used with default DHCP configuration in a network with a DHCP server but no DNS server. A fixed IP address is reserved within the DHCP server and is always assigned to the controller. The host name is set to `CONTROLLER-1`. The name resolution is done locally by updating the Windows "hosts" (or equivalent) file to reflect the fixed IP address corresponding to the host name of the Controller.

The user will need to go through the following steps:

1. Power-up the controller. It will auto-configure itself with DHCP and default host name.
2. Send a `MACADDR` MCL command serially via the hand terminal or the computer port to get the MAC address of the controller. Reserve an IP Address (e.g. 111.222.122.211) within the DHCP server that corresponds to the MAC address of the controller.
3. Send a `HOSTNAME CONTROLLER-1` MCL command serially via the hand terminal or the computer port to set the host name of the controller.
4. Send a `SAV` MCL command serially via the hand terminal or the computer port to save the changes in configuration.

5. Open the Windows “hosts” (or equivalent) file and add the following line at the end of the file:

```
111.222.122.211CONTROLLER-1#8752
```
6. Restart by pressing the **Set/Axis Enable**, **Driver**, and **Motor** buttons on the joystick, sending a Reset MCL command from any port, or doing a power-cycle.

After initialization is complete, confirm that the Ethernet connection is working by doing one or more of the following:

- Type `Ping CONTROLLER-1` at the MS-DOS prompt from a workstation with updated “hosts” file. Verify that the IP address is resolved to the controller’s IP address. You can check the controller’s IP address by issuing the `IPADDR` command from a handpad or Computer port.
- Open up a browser (Internet Explorer or Netscape) and type in `CONTROLLER-1` to access the web page. Verify the current network configuration displayed on the web page.
- Type `Telnet CONTROLLER-1` at the MS-DOS prompt.

Ethernet Configuration Example 4

The Ethernet controller is to be used in a network with no DHCP or DNS servers. The name resolution is done locally by updating the Windows “hosts” (or equivalent) file to reflect the fixed IP address corresponding to the host name of the controller. The controller will be assigned the following Static IP configuration:

```
IP Address: 123.213.132.231
Netmask: 255.255.255.0
Gateway address: 123.213.132.111
Host name: C1
```



If you type `IPMODE` or `IPADDR` without parameters as a query during this sequence, you will get an apparent erroneous response. This is because until the configuration is saved and reset, the actual address is undefined (if you booted up under DHCP, received no address or found no valid ethernet connection). The address cannot be reset until the controller is rebooted in its new `IPMODE`.

After step 4 below, the system will reconfigure itself to your selected IP address, and communication will function normally

The user will need to go through the following steps:

1. Start controller. It will try to find a DHCP server with no success.
2. Establish serial connection and send the following commands:
 - a. Change the host name: `HOSTNAME C1`
 - b. Change the mode to static: `IPMODE STAT`
 - c. Change the IP address: `IPADDR 123.213.132.231`
 - d. Change the gateway address: `GATEWAY 123.213.132.111`
 - e. Save the configuration: `SAV`
3. Open the Windows “hosts” (or equivalent) file and add the following line at the end of the file:

```
123.213.132.231          C1      #8752
```
4. Restart by pressing the **Set/Axis Enable**, **Driver**, and **Motor** buttons on the joystick, sending a `Reset MCL` command from any port, or doing a power-cycle. You can also cycle SW8 up then down to reset the controller.

After initialization is complete, confirm that the Ethernet connection is working by doing one or more of the following:

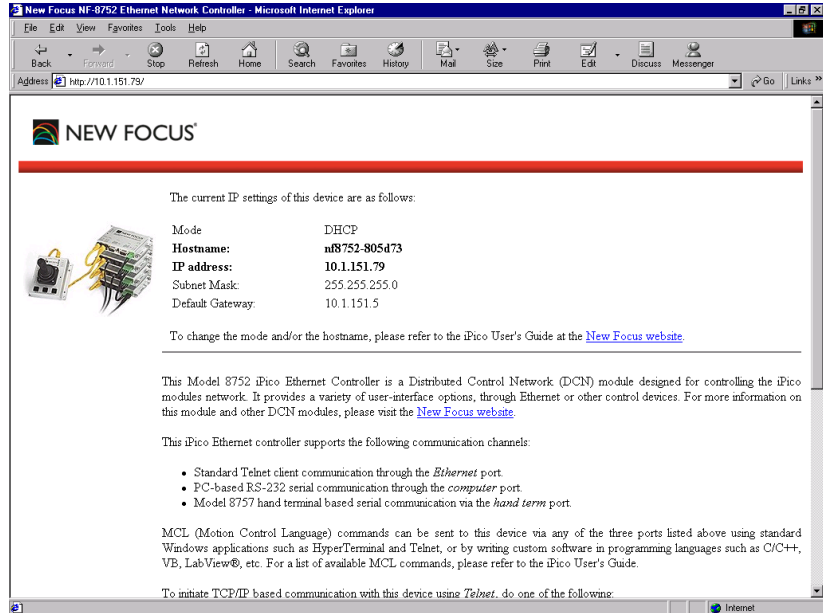
- Type `Ping C1` at the MS-DOS prompt. Verify that the IP address is resolved to the controller’s IP address. You can check the controller’s IP address by issuing the `IPADDR` command from a handpad or Computer port.
- Open up a browser (Internet Explorer or Netscape) and type in `C1` to access the web page. Verify the current network configuration displayed on the web page.
- Type `Telnet C1` at the MS-DOS prompt.

Web Page

As part of the Ethernet controller firmware, there is a display with a simple representation of the New Focus web page. It has a link that can be used to retrieve the actual web page. This web page shows the current IP settings of the Ethernet controller. In order to view this screen, it is first necessary to type in the host name or IP address. The

host name can be retrieved with the `hostname` command at the MCL command line, and the IP address can be retrieved by typing the command `ipaddr`.

Figure 23: New Focus web page



Using the Hand Terminal

The MCL commands can also be accessed using the Model 8757 hand terminal. All MCL commands can be typed directly into the hand terminal using its keypad. In this way, the hand terminal can control any driver or element in your network.

Rules of Operation

In addition to the rules of operation defined in the previous chapter (page 40), you need to keep the following in mind when using MCL:

- MCL commands can be sent even when the joystick is unplugged or is not present at power-up.
- INI is equivalent to a pressing the **Set/Axis Enable**, **Driver**, and **Motor** on the joystick.
- INI plus DEF is the same as the **Set/Axis Enable**, **Motor**, and **X+Y/Enable** buttons on the joystick.
- The saved values are loaded upon power-up or reset. A DEF command must be issued to return to the default values.
- The parameter settings for the stand-alone and command modes are self-contained. For example, when you switch from command to stand-alone mode, the joystick returns to the state it was last in when in stand-alone mode.
- You must always turn the joystick off (issue a JOF command) if you want to move the motors in command mode. If this is not done, MCL will try to start motion and the joystick will stop the motion, and the motors will only move a few pulses. Note that this is true even if the joystick is unplugged.
- Whenever an MCL command (e.g., MPV, VEL, or ACC) is issued for a motor channel different from the currently selected one, the motor channel is automatically changed to the new one.

Programming for the Network or Ethernet Controller

When programming for the network or Ethernet controller, keep the following rules in mind:

- All drivers on the network have unique addresses. A driver's address contains the letter 'A' and a number designating its position in the network. For example, the driver connected to the network controller will be A1. (The device address is not case sensitive.)

- Each Model 8753 driver can support up to three motors, numbered 0, 1, and 2, where 0=Motor A, 1=Motor B, and 2=Motor C.

Note:

When responding to a query, the controller designates the motors as M0, M1, and M2.

- Model 8751-C drivers support a single motor, which is usually omitted from MCL commands.
- The joystick has four digital inputs (buttons numbered 0 to 3) and eight digital outputs (LEDs numbered 0 to 7). The analog inputs are expressed in (x,y) coordinates of the joystick axis.

Controller Responses

The communication protocol is master-slave. The host sends a command to the network controller and the network controller sends back an answer. There are two types of answers:

- **Acknowledgment:** Upon successful completion of a command, there is a <Carriage return><Line feed><Greater than sign>.
- **Non-acknowledgment:** If there is a problem with the command syntax, the network controller will return <Carriage return><Line feed><Question mark>.

For example, the following commands will cause errors:

```
>ain 0
VALUE IS OUT OF RANGE - PARAMETER 1
?

>mp
UNKNOWN COMMAND
?
```

Conventions

The following pages contain a summary of all available commands, followed by detailed definitions for each command. The following conventions are used in both the “Command Summary” and the “Command Definitions” sections.

- The commands are case insensitive.
- Values to be input are indicated by angle brackets (<>) and are separated from the command by a space.
- Optional values are indicated by square brackets ([]).
- The = sign appears in several setup commands, but is not required. It is accepted as a convenience but ignored by the command line interpreter.

Command Summary

Note: *The MCL commands described in this manual apply to firmware revisions 1.5.0 or higher.*

Common Commands

Syntax	Command	Page
AIN <device> <channel>	Read/Display Analog Input	61
DEF	Load Default Parameters	62
DIAG <driver>	Display Diagnostics Byte from Device	62
IN <device> <channel>	Query State of Digital Inputs	89
LOCK	Lock Out Other Input Devices	63
MAP <joystick-device> = <driver>	Set/Display Device-to-Joystick Mappings	64
OUT <device> <channel>=<value>	Set Digital Output	65
SAV	Save Parameters	65
UNLOCK	Unlock Other Input Devices	66
VER	Query Firmware Version	66

Picomotor Control Commands

Syntax	Command	Page
	Set Absolute Position	67
ACC [<driver>] [<motor>]	Query Motor Acceleration	68
ACC <driver> <motor>=<value>	Set Motor Acceleration	69
CHL [<driver>]	Query Motor Channel	70
CHL <driver>=<motor>	Set Motor Channel	71
DRT	Query Driver Type	71
FIN <driver>	Find Index Mark in Forward Direction	72
FLI <driver>	Find Forward Limit	72
FOR <driver> [=<value>] [G]	Set Direction to Forward	73
GO [<driver>]	Start Motion	74
HAL [<driver>]	Stop Motion Smoothly	75
MOF [<driver>]	Disable Motor Driver	75
MON [<driver>]	Enable Motor Driver	76
MPV [<driver> [<motor>]]	Query Minimum Profile Velocity	77
MPV <driver> <motor>=<value>	Set Minimum Profile Velocity	78
NOS <driver>	Disable Closed-Loop Mode	79
POS [<driver>]	Query Motor Position	79
POS <driver>=<value>	Set Motor Position	80
REL <driver> =<value> [G]	Set Relative Position	81
REV <driver> [=<value>] [G]	Set Direction to Reverse	82
RIN <driver>	Find Index Mark in Reverse Direction	83
RLI <driver>	Find Reverse Limit	83
SER <driver>	Enable Closed-Loop Mode	84

Syntax	Command	Page
STA [<driver>]	Query Device Status	84
STO [<driver>]	Stop Motion	85
TYP [<driver>] [<motor>]	Query Motor Type	85
TYP <driver> <motor>=<type>	Set Motor Type	86
VEL [<driver>] [<motor>]	Query Motor Velocity	87
VEL <driver> <motor>=<value>	Set Motor Velocity	88

Joystick Control Commands

Syntax	Command	Page
JOF	Disable Joystick Control	90
JON	Enable Joystick Control	90
OUT [<LED>]	Query State of Digital Outputs	91
RES FINE	Set Velocity to Fine (250 Hz) Speed	91
RES COARSE	Set Velocity to Coarse (2000 Hz) Speed	92

Models LS-773 and LS-784 I/O Module Commands

Syntax	Command	Page
AIN <device> <channel>	Read/Display Analog Input	61
IN <device> <channel>	Query State of Digital Inputs	89
OUT <device> <bit>	Query State of Digital Outputs	91
PWM <device> <channel> <value>	Display Pulse-Width-Modulated Output	94
CNT <device> <resolution>	Read/Set/Clear Counter	93
TMR <device> <resolution>	Read/Set/Clear Timer	94

Ethernet Connectivity Commands

Syntax	Command	Page
HOSTNAME [<name>]	Set/Display Hostname	95
IPADDR [=<addr>]	Set/Display IP Address	95
IPMODE [=<mode>]	Set Display/IP Mode	96
NETMASK [=<addr>]	Set/Display Network Mask	96
GATEWAY [=<addr>]	Set/Display Gateway Address	96
DNSSRVR [=<addr>]	Set/Display DNS Server Address	97
PASSWD <value> <value>	Set Password	97
ECHO <port-name> <setting>	Set Port Echo	98
MACADDR	Display MAC Address	98

Command Definitions

Common Commands

Read/Display Analog Input

Syntax	AIN <device> <channel>
Description	<p>When the joystick is specified, it returns the values of both analog inputs (X and Y coordinates) or just that of a specified analog input corresponding to the current joystick position.</p> <p>When an I/O modules is specified, reads and displays analog inputs 0, 1, or 2.</p> <p>When a Model 8751-C closed-loop driver is specified, returns the analog input (linear potentiometer value). The voltage is measured as pin AN relative to pin AG. The maximum value will be returned if the voltage at AN equals or exceeds the voltage at AP. AP is set to 5 volts.</p> <p>Analog input is 8 bits.</p>
Argument	<p>Device = 0 for joystick attached to network controller; I0 to I31 for I/O devices; A1 to A31 for 8751-C drivers.</p> <p>I/O device and driver numbers count along daisy chain from network controller.</p> <p>Channel = 0, 1, 2 for I/O module; 1,2 for controller joystick port; n/a for 8751-C.</p>
Response	“channel_id=value”
Example	<p>To query joystick values:</p> <pre>>ain 0 IOA1=126 IOA2=131 ></pre> <p>To query 8751-C analog input, in network as device 1</p> <pre>>ain a1 A1=0 ></pre>

Load Default Parameters

Syntax	DEF
Description	Loads the default parameters: velocity = 2 kHz, acceleration = 32,000 steps/s ² , minimum profile velocity = 8 Hz.
Example	>def > (The default parameters are loaded.)

Display Diagnostics Byte from Device

Syntax	DIAG <driver>
Description	Displays diagnostics byte as returned from particular Pico device.
Argument	Driver: A1 to A31
Response	"<driver>= x"
Example	>diag a1 > A1=0 (Physical device 1 has diagnostic byte 0.)

Initialize Devices on Network

Syntax	INI
Description	Initializes all the devices on the network. This command is also executed after power-up.
Example	>ini > (All of the devices on the network are initialized.)

Lock Out Other Input Devices

Syntax	LOCK
Description	<p>This command issued from any connected input device (JOYS, COMA, COMD or ETHO) locks out all other connected devices.</p> <p>When the joystick (JOYS) is locked out, all of its LEDs are turned on. When the hand terminal (COMD) is locked out, a message, “Locked” is displayed on the screen and no further keystrokes are accepted. If the serial console (COMA) or Telnet session (ETHO) are locked out, any command entered on those devices will be rejected with error LOCKED.</p>
Example	<pre>>lock ></pre> <p>(Locks out all other connected input devices.)</p>

Set/Display Device-to-Joystick Mappings

Syntax	MAP <joystick-device> = <driver>
Description	<p>Sets or displays current device-to-joystick mappings. Initially, joystick device 1 is mapped to physical device 1, 2 to 2, and 3 to 3. Set commands works only in joystick-off (JOFF) mode and allows for setting mapping of devices.</p> <p>The current map is shown on the hand terminal first line display as 1=driver1 2=driver2 3=driver3 where driver 1,2,3 are the currently mapped drivers.</p>
Argument	Driver: A1 to A31
Response	"<driver>=<motor>"
Example 1	<pre>>map > M1=1 M2=2 M3=3 (Displays current mapping.)</pre>
Example 2	<pre>>map 1=4 > M1=4 (Maps first joystick-controlled device to fourth physical Pico driver.) The hand terminal display will change to: 1=04 2=02 3=03</pre>

Set Digital Output

Syntax	OUT <device> <channel>=<value>
Description	Sets a digital output on an I/O modules (Digital Outs 0 to 6) or joystick (LEDs 0 to 7). <i>Note: The actual state of the digital outputs 1 and 2 are controlled also by PWM command. Joystick outputs are dependent on current status of Pico devices.</i>
Argument	Device: I1 to I31 Channel: 0 to 6 for I/O module; 0 to 7 for joystick
Response	"<dev>=<channel>"
Example	>out I1 2 1 > I1D2=1

Save Parameters

Syntax	SAV
Description	Saves velocity, acceleration, minimum profile velocity and motor type parameters for all drivers. Saves IP mode and address for ethernet controller.
Example	>sav > (The operational parameters are saved.)

Unlock Other Input Devices

Syntax	UNLOCK
Description	Removes a lock issued from a device, returning all other connected devices back to accepting commands. The UNLOCK command must be from device that originated LOCK command. The locked hand terminal will display message UnLocked and will return to normal operation. If a joystick is unlocked, its LEDs will display normal status of connected devices and channels.
Example	>unlock > (Locks all devices except the device originating the command.)

Query Firmware Version

Syntax	VER
Description	Returns the firmware version. <i>Note: Only firmware revisions 1.5.0 and higher will support closed-loop picomotors.</i>
Example	>ver Version 1.5.0 > (The controller is running firmware version 1.5.0.)

Picomotor Control Commands

Set Absolute Position

Syntax	ABS <driver> =<value> [G]
Description	<p>When using Model 8751-C, the driver will move until current position is X or limit is encountered. If 8751-C is used in open-loop mode (see SER/NOS commands), sends X pulses to driver at 1 kHz rate, up to a maximum of 255.</p> <p>When using Model 8753, add +/-X to encoder counts (same as REL).</p> <p>Optional “G” parameter causes immediate execution of the specified motion.</p>
Argument	<p>Driver: A1 to A31</p> <p>Value: -2,147,483,648 to 2,147,483,647</p> <p>G: Execute command immediately if present. Otherwise, store this motion to execute on next GO command.</p>
Example	<p>To move closed loop motor to encoder count 1000, immediately:</p> <pre>>ABS a1=1000 g ></pre> <p>To move closed loop motor on driver 1 to count -10, closed-loop motor on driver 2 to count 5, open-loop motor on driver 3 active channel forward by 17 pulses (note optional use of = sign):</p> <pre>>ABS a1=-10 >ABS a2 5 >ABS a3=17 >GO ></pre>

Query Motor Acceleration

Syntax	ACC [<driver>] [<motor>]
Description	Returns the acceleration for all motors, for the three motors of a specified driver, or for a specified motor on a particular driver.
Argument	Driver: A1 to A31 Motor: 0 to 2
Response	"<driver> <motor>=<value>" x = 16 to 32000 Units: steps/s ²
Example 1	>acc A1 M0=20000 A1 M1=20000 A1 M2=20000 A2 M0=10000 A2 M1=10000 A2 M2=10000 > (There are two drivers on the system, A1 and A2. All motors on A1 are set to accelerate at 20,000 steps/s ² ; all motors on A2 are set to accelerate at 10,000 steps/s ² .)
Example 2	>acc a1 A1 M0=20000 A1 M1=20000 A1 M2=20000 > (The motors on driver A1 are all set to accelerate at 20,000 steps/s ² .)
Example 3	>acc a2 2 A2 M2=10000 > (The acceleration for motor 2 on driver A2 is 10,000 steps/s ² .)

Set Motor Acceleration

Syntax	ACC <driver> <motor>=<value>
Description	<p>Sets the acceleration of a specified motor. The channel is changed automatically when issued while in command mode.</p> <p><i>Note: If a VEL, MPV, or ACC command is issued while in command mode, then these become the current values for the joystick and stay current until saved or default values are loaded by INI, DEF, reset or power-up.</i></p>
Argument	<p>Driver: A1 to A31</p> <p>Motor: 0, 1, or 2</p> <p>Value: 16–20,000</p> <p>Units: steps/s²</p>
Example	<p>Set the acceleration for motor 1 on driver A2 to 10,000 steps/s²:</p> <pre>>acc a2 1=10000 ></pre>

Query Motor Channel

Syntax	CHL [<driver>]
Description	<p>This command is only valid when used with the Model 8753 open-loop driver.</p> <p>Returns the selected motor channels for all the drivers or for a single specified driver.</p> <p><i>Note: Each driver can support up to three motors, but only one motor channel can be selected at a time.</i></p>
Argument	Driver: A1 to A31
Response	“<driver>=<value>” <value> = 0, 1, or 2
Example 1	<pre>>chl A1=0 A3=1 ></pre> <p>(Motor channel 0 (A) is selected on driver A1, motor channel 1 (B) is selected on driver A3, driver A2 is an 8751-C closed loop driver).</p>
Example 2	<pre>>chl a2 A2=1 ></pre> <p>(Motor channel 1 is selected on driver A2.)</p>

Set Motor Channel

Syntax	CHL <driver>=<motor>
Description	<p>This command is only valid when used with the Model 8753 open-loop driver.</p> <p>Sets the motor channel for a specified driver.</p> <p><i>Note: Each driver can support up to three motors, but only one motor channel can be selected at a time.</i></p>
Argument	Driver: A1 to A31 Motor: 0, 1, or 2
Example	Set the motor channel to 1 for driver A1: >chl a1=1 >

Query Driver Type

Syntax	DRT
Description	Returns the picomotor driver type.
Response	“1” for 3-channel open loop driver; “2” for 1-channel closed loop driver
Example	>DRT A1=2 A2=1 > First driver in daisy-chain is 8751-C, second driver is 8753.

Find Index Mark in Forward Direction

Syntax	FIN <driver>
Description	<p>Starts motion with currently selected acceleration, stops at first index pulse received on Z digital input. Direction is forward (increasing encoder counts) for FIN, reverse for RIN.</p> <p><i>Note: The revision of Model 8310 closed-loop Picomotor actuators shipping in 2003 does not have an internal index mark. This command watches the Z digital input of the driver and stops motion if that input is brought high.</i></p>
Argument	Driver: A1 to A31
Example	<pre>>FIN a1 ></pre> <p>(Sends 8751-C driver forward at currently stored velocity until Z pin of driver is pulled low.)</p>

Find Forward Limit

Syntax	FLI <driver>
Description	<p>Starts forward motion with currently selected mode (open loop/ closed loop) and velocity/acceleration parameters. The motor stops at the forward limit.</p> <p>If the forward limit is activated before issuing the command, the motor will first move in reverse direction to clear the limit and then will find the limit moving forward.</p>
Argument	Driver: A1 to A31
Example	<pre>>FLI a1 ></pre> <p>Sends closed loop motor on driver a1 moving with current velocity program until forward limit is reached or HAL/STO command is sent.</p>

Set Direction to Forward

Syntax	FOR <driver> [=<value>] [G]
Description	<p>When using a Model 8751-C closed-loop driver, moves in velocity profiled mode.</p> <p>When using a Model 8753 open-loop driver, resets the specified driver so it will move forward with either the currently set velocity or a specified velocity.</p> <p>If optional [<value>] parameter is included, this is the motion velocity.</p> <p>If optional [G] parameter is included, execution is immediate, rather than stored until the next GO command.</p> <p>Motion is profiled according to set acceleration (ACC).</p>
Argument	<p>Driver: A1 to A31</p> <p>Value: 1 to 2000; should be greater than MPV</p> <p>Units: Hz</p> <p>G: Execute command immediately if present.</p>
Example 1	<p>Set A1 to move forward with current speed, execute immediately:</p> <pre>>for a1 g ></pre>
Example 2	<p>Set A1 so it will move forward with a speed of 1500 Hz:</p> <pre>>for a1=1500 ></pre>

Start Motion

Syntax	GO [<driver>]
Description	<p>Starts the currently selected motor (for all drivers or only a specified driver) using the previously defined trajectory parameter.</p> <p>If trajectory is not changed after a GO (by issuing a new ABS, REL, FOR or REV), consecutive GO commands will repeat the same requested motion.</p> <p><i>Note: Before issuing this command, you should turn the joystick off (JOF). You should also select a channel (CHL), turn on the motor driver (MON), set the velocity (VEL), and set a motor command (REL, FOR, or REV).</i></p>
Argument	Driver: A1 to A31
Example 1	<p>Start the motion of all motors:</p> <pre>>go ></pre>
Example 2	<p>Start the motion of the selected motor on driver A2:</p> <pre>>go a2 ></pre>

Stop Motion Smoothly

Syntax	HAL [<driver>]
Description	<p>When using a Model 8751-C closed-loop driver in closed-loop mode, the motor will decelerate and hold position at the position where it stops. When using a Model 8751-C closed-loop driver in open-loop mode, the driver will immediately stop sending pulses.</p> <p>When using a Model 8753 open-loop driver, the HAL command will smoothly stop all active motors according to their programmed acceleration properties.</p>
Argument	Driver: A1 to A31
Example 1	Stop the movement of all motors: >hal >
Example 2	Stop the movement of the motor on driver A1: >hal a1 >

Disable Motor Driver

Syntax	MOF [<driver>]
Description	Turns off all motor channels on all drivers or on the selected driver. You can still set parameters for disabled drivers, but the GO command will be ignored.
Argument	Driver: A1 to A31
Example 1	Turn off all drivers: >mof >
Example 2	Turn off driver A1: >mof a1 >

Enable Motor Driver

Syntax	MON [<driver>]
Description	Enables all drivers or the specified driver. A driver must be enabled before you can run any motors attached to that driver.
Argument	Driver: A1 to A31
Example 1	Enable all connected drivers: >mon >
Example 2	Enable driver A1: >mon a1 >

Query Minimum Profile Velocity

Syntax	MPV [<driver>[<motor>]]
Description	<p>This command is only valid when used with the Model 8753 open-loop driver.</p> <p>Returns the Minimum Profile Velocity (MPV) parameter for all the drivers, a specified driver, or a specified motor.</p> <p><i>Note: In the stand-alone mode, a higher MPV results in a larger dead zone of the joystick. An MPV near the velocity will create a “bang-bang” mode for the joystick, where the joystick will only move the motor at full velocity, and only when the joystick is set near the limit of its travel. In the command mode, a higher MPV will reduce the acceleration time to achieve a specified velocity.</i></p>
Argument	Driver: A1 to A31 Motor: 0, 1, or 2
Response	“<driver> <motor>=<value>” <value> = 0 to 1999 Units: Hz
Example 1	<pre>>mpv A1 M0=8 A1 M1=8 A1 M2=8 A2 M0=8 A2 M1=8 A2 M2=8 ></pre> <p>(The MPV for all motors on all drivers is 8 Hz.)</p>
Example 2	<pre>>mpv a1 A1 M0=8 A1 M1=8 A1 M2=8 ></pre> <p>(The MPV for all motors on driver A1 is 8 Hz.)</p>
Example 3	<pre>>mpv a1 0 A1 M0=8 ></pre> <p>(The MPV for motor 0 on driver A1 is 8 Hz.)</p>

Set Minimum Profile Velocity

Syntax	MPV <driver> <motor>=<value>
Description	<p>This command is only valid when used with the Model 8753 open-loop driver.</p> <p>Sets the MPV for the specified motor. The channel is changed automatically when issued while in command mode.</p> <p><i>Note: In the stand-alone mode, increasing the MPV will increase the dead zone of the joystick. Setting the MPV near the velocity will create a “bang-bang” mode for the joystick, where the joystick will only move the motor at full velocity, and only when the joystick is set to the limit of its travel. In the command mode, a higher MPV will reduce the acceleration time to achieve a specified velocity.</i></p> <p><i>Note: If the velocity is set to a value less than the MPV, the controller will automatically set MPV to MPV=velocity-1.</i></p> <p><i>Note: If a VEL, MPV, or ACC command is issued while in command mode, then these become the current values for the joystick and stay current until saved or default values are loaded by INI, DEF, reset or power-up.</i></p>
Argument	Driver: A1 to A31 Motor: 0, 1, or 2 Value: 0 to 1999 (integer), must be less than velocity. Units: Hz
Response	2; will only respond when connected to the Model 8751-C closed-loop driver, which does not support this command
Example	Set the MPV for motor 0 on driver A1 to 1 Hz: >mpv a1 0=1 >

Disable Closed-Loop Mode

Syntax	NOS <driver>
Description	This command is only valid when used with the Model 8751-C closed-loop driver. Disables closed-loop mode (enables open-loop mode).
Argument	Driver: A1 to A31
Example	>NOS a2 > (Puts 8751-C driver at network position 2 into open-loop mode.)

Query Motor Position

Syntax	POS [<driver>]
Description	For a Model 8753 open-loop driver, returns the number of pulses sent to the motor since the last motion command. You can query the pulses for active motors on all drivers or on a specified driver. For a Model 8751-C closed-loop driver, returns the current position in encoder counts.
Argument	Driver: A1 to A31
Response	"<driver>=<value>" <value> = -2147483648 (0x80000000) to +2147483647 (0x7FFFFFFF)
Example	>pos A1=1990 A2=0 > (There have been 1990 pulses sent to the active motor on driver A1 since the last command; 0 pulses have been sent to the active motor on driver A2.)

Set Motor Position

Syntax	POS <driver>=<value>
Description	This command is only valid when used with the Model 8751-C closed-loop driver. For model 8751-C closed loop driver, sets the currently stored position to X.
Argument	Driver: A1 to A31 X: -2,147,483,648 to 2,147,483,647
Example	>POS a1 100 > (Sets current value of position for 8751-C driver at network location 1 to be 100 encoder counts.)

Set Relative Position

Syntax	REL <driver> =<value> [G]
Description	<p>Sets the number of forward or backward steps to move the active motor on the specified driver.</p> <p>For Model 8753, this command is identical to ABS.</p> <p>For Model 8751-C, in closed-loop mode (see SER/NOS), causes specified driver to move its by motor <value> encoder counts.</p> <p>For model 8751-C, in open-loop mode, causes specified driver to send -255 to 255 pulses at 1 kHz rate.</p> <p>If optional [G] parameter is included, execution is immediate, rather than stored until the next GO command.</p>
Argument	<p>Driver: A1 to A31</p> <p>Value: -2147483648 (0x80000000) to +2147483647 (0x7FFFFFFF)</p> <p>G: Execute command immediately if present.</p>
Example 1	<pre>>SER >REL a1 100 g ></pre> <p>(Moves closed loop motor on driver 1 forward by 100 encoder counts. Executes immediately.)</p>
Example 2	<pre>>NOS >REL a1 1000 >REL a2 1000 >GO ></pre> <p>Moves closed loop motor on driver 1 forward by 255 motor pulses (approximately 85 encoder counts), at 1 kHz pulse rate.</p> <p>Moves open loop motor on driver 2 forward by 1000 motor pulses at currently stored velocity and acceleration.</p>

Set Direction to Reverse

Syntax	REV <driver> [=<value>] [G]
Description	<p>When using a Model 8751-C closed-loop driver, moves in velocity profiled mode.</p> <p>When using a Model 8753 open-loop driver, presets the driver to move in reverse with either the current speed or a specified speed.</p> <p>If optional [<value>] parameter is included, this is the motion velocity.</p> <p>If optional [G] parameter is included, execution is immediate, rather than stored until the next GO command.</p> <p>Motion is profiled according to set acceleration (ACC).</p>
Argument	<p>Driver: A1 to A31</p> <p>Value: 1 to 2000; should be greater than MPV</p> <p>Units: Hz</p> <p>G: Execute immediately.</p>
Example	<p>Preset driver A1 to move in reverse with a speed of 1500 Hz:</p> <pre>>rev a1 = 1500 ></pre>

Find Index Mark in Reverse Direction

Syntax	RIN <driver>
Description	<p>Starts motion with currently selected acceleration, stops at first index pulse received on Z digital input. Direction is forward (increasing encoder counts) for FIN, reverse for RIN.</p> <p><i>Note: The revision of Model 8310 closed-loop Picomotor actuators shipping in 2003 does not have an internal index mark. This command watches the Z digital input of the driver and stops motion if that input is brought high.</i></p>
Argument	Driver: A1 to A31
Example	<pre>>RIN a1 ></pre> <p>(Sends 8751-C driver in reverse at currently stored velocity until Z pin of driver is pulled low.)</p>

Find Reverse Limit

Syntax	RLI <driver>
Description	<p>Starts reverse motion with currently selected mode (open loop/closed loop) and velocity/acceleration parameters. The motor stops at the reverse limit.</p> <p>If the reverse limit is activated before issuing the command, the motor will first move in forward direction to clear the limit and then will find the limit moving in reverse direction.</p>
Argument	Driver: A1 to A31
Example	<pre>>RLI a1 ></pre> <p>(Sends closed loop motor on driver a1 moving with current velocity program until forward limit is reached or HAL/STO command is sent.)</p>

Enable Closed-Loop Mode

Syntax	SER <driver>
Description	This command is only valid when used with the Model 8751-C closed-loop driver. Enables the closed-loop mode and starts the driving at current position.
Argument	Driver: A1 to A31
Example	>SER a2 > (Enables closed-loop mode and starts the driver.)

Query Device Status

Syntax	STA [<driver>]
Description	Returns the status bytes of all drivers or just that of a specified driver. <i>Note: The status byte of the Model 8751-C closed-loop driver shows the current state of the limits when the drive is in OK condition.</i>
Argument	Driver: A1 to A31
Response	See the “Model 8753 Driver: Status Byte” on page 185 for status byte descriptions.
Example	>sta SYSTEM STATUS: 0x0 A1=0x3D A2=0x1C NO ERROR, READY > (The status byte of each driver is returned.)

Stop Motion

Syntax	STO [<driver>]
Description	<p>When using a Model 8751-C closed-loop driver in closed-loop mode, the motor will hold at this position.</p> <p>When using a Model 8753 open-loop driver or a Model 8751-C in open-loop mode, this command abruptly stops the motion of active motors on all drivers or just the motor on a specified driver.</p>
Argument	Driver: A1 to A31
Example	<pre>Stop the motion of the active motor on driver A1: >sto A1 ></pre>

Query Motor Type

Syntax	TYP [<driver>] [<motor>]
Description	<p>This command is only valid when used with the Model 8753 open-loop driver.</p> <p>Returns the motor type setting for the selected channel on all the drivers, for the selected channel on a specified driver, or for the specified channel on a driver.</p> <p><i>Note: This query returns only the motor type setting for a channel. The actual type of motor that is connected may be different.</i></p>
Argument	Driver: A1 to A31 Motor: 0, 1, or 2
Response	“0” for Standard Picomotor; “1” for Tiny Picomotor
Example	<pre>>typ a1 0 0 ></pre> <p>(Motor channel 0 on driver A1 is set to Standard motor type.)</p>

Set Motor Type

Syntax	TYP <driver> <motor>=<type>
Description	This command is only valid when used with the Model 8753 open-loop driver. Sets the motor type for a specified channel. <i>Note: This only sets the motor type in the controller settings. The actual type of motor that is connected may be different.</i>
Argument	Driver: A1 to A31 Motor: 0, 1, or 2 Type: 0 = Standard Picomotor, 1 = Tiny Picomotor
Example	Set motor 0 on driver A1 to Tiny motor type: >typ a1 0=1 >

Query Motor Velocity

Syntax	VEL [<driver>] [<motor>]
Description	<p>Returns the velocity in velocity mode or goal velocity in trapezoidal mode.</p> <p>You can query the velocity for all motors, for the three motors of a specified driver, or for a specified motor on a particular driver.</p> <p><i>Note: If a VEL, MPV, or ACC command is issued while in command mode, then these become the current values for the joystick and stay current until saved or default values are loaded by INI, DEF, reset or power-up.</i></p> <p>For Model 8751-C drivers, <motor> is an optional parameter. Any value 0,1, or 2, or no <motor> at all causes the single axis of 8751-C to be set to the specified <value>.</p>
Argument	<p>Driver: A1 to A31</p> <p>Motor: 0, 1, or 2; for 8751-C this parameter is optional.</p>
Response	<p>“<driver> <motor>=<value>”</p> <p><value> = 0 to 2000</p> <p>Units: Hz</p>
Example	<pre>>vel a1 2 A1 M2=2000 ></pre> <p>(The velocity of motor 2 on driver A1 is 2000 Hz.)</p>

Set Motor Velocity

Syntax	<code>VEL <driver> <motor>=<value></code>
Description	<p>Sets the velocity for the specified motor. The channel is changed automatically when issued while in command mode.</p> <p>The firmware will convert the value to the closest possible.</p>
Argument	<p>Driver: A1 to A31</p> <p>Motor: 0, 1, or 2</p> <p>Value: 1 to 2000; should be greater than MPV</p> <p>Units: Hz</p>
Example	<p>Set the velocity of motor 1 on driver A1 to 1000 Hz:</p> <pre>>vel a1 1=1000 ></pre>

Joystick Control Commands

Query State of Digital Inputs

Syntax	IN <device> <channel>
Description	Reads a digital input from I/O module (Digital IN 0–9) or joystick device (buttons). Button: 0 = Set Axis/Enable button 1 = Driver button 2 = Motor button 3 = X+Y/Enable button
Argument	Device: I1 to I31 Channel: 0 to 9 for I/O module; 8 to 11 for joystick, where Set Axis/Enable button equals 8, Driver button equals 9, etc.
Response	“<device>I<channel>=<value>” <value> = 0, 1 (low, high)
Example	in I1 9 > I1D2=1 (The Motor button on the joystick is on.)

Disable Joystick Control

Syntax	JOF
Description	<p>Turns off the joystick stand-alone mode, and all LEDs on the joystick turn on.</p> <p>The joystick is put into command mode, where the controller will respond to MCL commands from a PC. In this mode, the joystick inputs (buttons) will not function as in the stand-alone mode but can act as user inputs for a user-defined program.</p>
Example	<p>Turn off stand-alone mode:</p> <pre>>jof ></pre>

Enable Joystick Control

Syntax	JON
Description	<p>The joystick is set to stand-alone mode, and the controller will respond to the user pressing various buttons on the joystick as defined in Pressing the Set/Axis Enable, Motor, and X+Y/Enable buttons on the joystick will reset the network and load the default parameters. This will work even when the joystick is turned off by a JOF MCL command.</p> <p>The default mode on power-up is the stand-alone mode.</p>
Example	<p>Turn on stand-alone mode:</p> <pre>>jon ></pre>

Query State of Digital Outputs

Syntax	OUT <device> <bit>
Description	Returns the states of the all the digital outputs or just that of a specified LED on the joystick.
Argument	Device: 0 for joystick; I1 to I31 for networked I/O controllers. Bit: 0 to 7 for joystick; 0 to n for n-output bit I/O controller.
Response	“I<device>O<bit>=y” y = “0” for off, “1” for on
Example	>out i0 7 I007=0 > (The LED 7 on the joystick is off.)

Set Velocity to Fine (250 Hz) Speed

Syntax	RES FINE
Description	Sets velocity for axes which are currently selected by joystick to 250 Hz maximum. <i>Note: RES commands only apply to the currently active Joystick axes.</i>
Example	>res fine > (Speed set to Fine, or low, speed.)

Set Velocity to Coarse (2000 Hz) Speed

Syntax	RES COARSE
Description	Sets velocity for axes which are currently selected by joystick to 2000 Hz maximum. <i>Note: RES commands only apply to the currently active Joystick axes.</i>
Example	> res coarse > (Speed set to coarse, or high speed.)

Models LS-773 and LS-784 I/O Module Commands

Note:

The following commands are unique to LS-773 and LS-784 I/O modules. Other I/O commands, which apply to both I/O modules and joystick are listed in the preceding joystick command section. See page 59 for the complete I/O Module command index.

Read/Set/Clear Counter

Syntax	CNT <device> <resolution>
Description	Reads, sets or clears a counter. The counter is connected to digital input 9 (Digital In 9) on the LS-773 or LS-784 modules.
Argument	Device: I1 to I31 Resolution: 0, 1, 2, 4, or 8 Resolution sets the number of transitions of Digital Input 9 (or Button 2) required to increment the value of the counter by one (e.g. Cnt I1 8 will cause each 8th change of digital input 9 to increment the counter by one). Setting the resolution equal to 0 stops and clears the counter. No value supplied will return the current value of the counter.
Example	>cnt I1 1 (The counter for device I1 is set to a resolution of 1.) >cnt I1 (The counter is read.) >cnt I1 0 (The counter is stopped and reset.) >cnt I1 2 (The counter reads every second count.)

Display Pulse-Width-Modulated Output

Syntax	PWM <device> <channel> <value>
Description	Sets or displays the Pulse-Width-Modulated output for digital outputs 1 and 2 of LS-773 or LS-784. Effect of those commands is visible if those outputs are enabled (see OUT command).
Argument	Device: I1 to I31 Channel: 1 or 2 Value: 0 to 255
Response	"I<device><channel>= <value>"
Example	>pwm I1 1 127 > I1D1=127 >out I1 1 1 I1D1=1 (Now output 1 of LS-773 is modulated with a fill ratio of about 50%.)

Read/Set/Clear Timer

Syntax	TMR <device> <resolution>
Description	Reads, sets, or clears a timer. The timer is internal to the I/O modules and joystick devices.
Argument	Device: I1 to I31 Resolution: 0, 1, 2, 4, or 8 Resolution sets how fast the timer will be incremented: 1 = every 0.2 μ s., 2 = every 0.2 μ s; 4 = every 0.8 μ s; 8 = every 1.6 μ s. Setting the resolution equal to zero stops and clears the timer. When no resolution value is supplied, the current value of the timer is returned.
Example	>tmr I1 1 (The timer for device I1 is set to a resolution of 1.) >tmr I1 (The counter is read.) >tmr I1 0 (The counter is stopped and reset.)

Ethernet Connectivity Commands

Note:

The following commands are valid only on the Model 8752 Ethernet Controller.

Note:

If any network parameters are changed, they must be saved to the non-volatile memory (with the SAV command), and controller restarted in order for settings to come into effect.

Set/Display Hostname

Syntax	HOSTNAME [<name>]
Description	<p>Sets or displays controller's host name. Name should consist of letters, digits, "-" and "_" characters, and be no longer than 20 characters.</p> <p>Factory default name of the controller is nf8752-xyyz, where xyyz are the last six Hexadecimal digits from the MAC address of the controller, or 000000 for non Ethernet controllers. There are several commands which change the IP address of the controller.</p>
Example	<pre>>hostname > (The hostname is displayed)</pre>

Set/Display IP Address

Syntax	IPADDR [=<addr>]
Description	<p>Sets or displays the IP address of the controller (valid only if IPMODE=STAT).</p> <p>Set is only valid when IPMODE=STAT. A new IP address is not actually stored until next boot-up. Query after set will return prior address, but will be re-set after boot-up.</p>
Argument	Addr: "aaa.bbb.ccc.ddd", with each aaa, bbb, ccc, ddd in the range 0 to 255. Exact values depend on customer's network infrastructure.
Example	<pre>>ipaddr > (The stored IP address is displayed.)</pre>

Set Display/IP Mode

Syntax	IPMODE [=<mode>]
Description	Defines whether DHCP server will be used on subsequent boots, or IP parameters will be defined manually.
Argument	Mode = DHCP (default) or STAT
Example	>IPMODE=DHCP > (The DHCP server will be used upon reboot.)

Set/Display Network Mask

Syntax	NETMASK [=<addr>]
Description	Sets or displays the network mask of the controller.
Argument	Addr: “aaa.bbb.ccc.ddd”, with each aaa, bbb, ccc, ddd in the range 0 to 255. Exact values depend on customer’s network infrastructure.
Example	>netmask > (The stored netmask is displayed.)

Set/Display Gateway Address

Syntax	GATEWAY [=<addr>]
Description	Sets or displays the gateway address of the controller (valid only if IPMODE=STAT).
Argument	Addr: “aaa.bbb.ccc.ddd”, with each aaa, bbb, ccc, ddd in the range 0 to 255. Exact values depend on customer’s network infrastructure.
Example	>gateway > (The stored gateway address is displayed.)

Set/Display DNS Server Address

Syntax	DNSSRVR [=<addr>]
Description	Sets or displays the DNS server address of the controller (valid only if IPMODE=STAT).
Argument	Addr: “aaa.bbb.ccc.ddd”, with each aaa, bbb, ccc, ddd in the range 0 to 255. Exact values depend on customer’s network infrastructure.
Example	<pre>>dnserver ></pre> <p>(The stored name (DNS) server address is displayed.)</p>

Display Firmware Version

Syntax	VER
Description	Displays the version of the firmware. <i>Note: Version must be 1.5.0 or higher to support the Model 8751-C closed-loop drivers.</i>

Set Password

Syntax	PASSWD <value>
Description	When the controller is restarted, it checks the setting of DIP switch SW2. If this switch is set to ON (up), then the controller asks for password on subsequent Telnet sessions. The default password is empty, and can be changed by PASSWD command. If the DIP switch is set to OFF, no password is required to start Telnet session.
Example	<pre>passwd 1234 (creates password 1234) > >passwd PASSWD:1234</pre>

Set Port Echo

Syntax	ECHO <port-name> <setting>
Description	By default, the controller echoes back characters only on the hand terminal and does not echo Serial A and Telnet sessions. This behavior can be changed by the ECHO Command. If <setting> is omitted, current settings are displayed.
Argument	Port-name: ComA, ComD, or Echo Setting: OFF or ON
Example	>Echo ComA ON (Sets the controller to echo the ComA port session.) > Echo >ComD On (The controller is set to echo the session on Com D.)

Display MAC Address

Syntax	MACADDR
Description	Displays the hardware MAC (media access control) address of ethernet-based controller. This command could be used for trouble shooting Ethernet configurations, e.g. to check what address the controller has been assigned from a DHCP server. Last six digits of MAC address are used to generate default host name of the controller. This address is hardware dependent, unique, and cannot be changed.

Examples

Example 1

To first disable the joystick and then drive a Standard Picomotor hooked up to driver A2, motor B, in velocity mode at 500 Hz clockwise (forward) with minimum velocity of 0 and acceleration of 5000 steps/sec², and then enable the joystick back on, the sequence of commands will be as follows:

```
>jof
>chl a2=1
>typ a2 1=0
>mpv a2 1=0
>vel a2 1=500
>acc a2 1=5000
>mon
>pos
A1=0
A2=0
>for a2
>go
>sto
>pos
A1=0
A2=1832
>jon
```

Example 2

To simultaneously drive two Tiny Picomotors hooked up to driver A1, motor A, and driver A2, motor B, for 5000 steps counterclockwise (backward) and 10000 steps clockwise (forward), respectively, in position mode at a velocity of 2000Hz and with default minimum velocity and acceleration values, the sequence of commands will be as follows:

```
>jof
>def
>chl a1=0
>chl a2=1
>typ a1 0=1
>typ a2 1=1
>vel a1 0=2000
>vel a2 1=2000
>mon
>pos
A1=0
A2=0
>rel a1=-5000
>rel a2=10000
>go
>pos
A1=-5000
A2=10000
>jon
```

Example 3

To permanently set the maximum velocity in the stand-alone mode to be 10 Hz and to achieve proportional control from 1 Hz to 10 Hz for a particular channel on a particular driver (e.g., motor A on driver A1), the sequence of commands will be as follows:

```
>mpv A1 0=0
>vel A1 0=10
>sav
```

Computer Control: Using the DCN Interface

Overview

The New Focus Picomotor DCN Set-Up and Diagnostic Utility allows users to test the basic functionality of the Picomotor driver, joystick, and I/O modules. The utility is written in Visual Basic and uses DLL functions to communicate with the modules.

The DCN Set-Up and Diagnostic Utility can be found on the New Focus web site.

Note: *This program cannot be used with the Model 8750 network controller or Model 8752 Ethernet controller.*

Using the RS-485 Interface

Driver(s) and I/O Module(s) Only

If your installation uses Picomotor drivers only, the first driver in the network needs to be connected to one of the **COM** ports of a PC using the New Focus Model 8761 Intelligent Picomotor Computer Interface Kit (see “Intelligent Picomotor Accessories” on page 19).

Note: *See “Using DLL/DCN with the Driver(s) and I/O Module(s)” on page 34 for more detailed set-up instructions.*

Driver(s), I/O Module(s), and Joystick

If your installation includes a joystick along with the Picomotor drivers and I/O Modules, the joystick needs to be connected to the COM port of a PC using the Model 8761 interface kit. The Picomotor drivers should then be connected to the joystick.

Note: *The dipswitch settings of the joystick need to be changed from their default positions.*

Note: *See “Using DLL/DCN with the Driver(s), I/O Module(s), and Joystick” on page 35 for more detailed set-up instructions.*

The examples in this chapter are for a network which contains four elements: a joystick, a Model 8751-C closed-loop driver, a Model 8753 intelligent multi-axis driver, and an LS-773 network I/O module.

Rules of Operation

When setting up the DCN Utility for communication with the driver(s) and joystick, you will need to keep the following in mind:

- When starting the DCN Utility for the first time (or if the “Dcn.ini” file is missing), the first found **COM** port is chosen by default. A list of connected modules should appear on the left.
 - If the wrong **COM** port is chosen by default, select the correct one. The network will automatically reset.
 - If a **COM** port is not in the list of available ports, another application may have control of it, or it may not exist. Close the other application or check your hardware configuration as required and restart the DCN Utility.
 - If no modules are found, re-check your connections, make sure logic power is supplied to all the modules, and verify that all modules have had the proper terminator settings.
 - If some but not all modules are found, re-check your connections and reset the network manually using the **Reset Network** button. The **Reset Device** button can be used to reset the currently selected module instead of the entire network.

- The default baud rate for communication is 19200; there is no real need to operate at other baud rates except to test the hardware reliability at higher communication rates.
- With a number of DCN modules connected to one of the **COM** ports, this utility will search for modules and initialize them with addresses starting at 1 for the first module. The list on the left side of the DCN Utility window will show all of the modules found on the network, along with their assigned addresses, types, and version numbers.
- Clicking on one of the modules in the module list will cause that module's properties to be displayed in the control panel on the right. If a Picomotor driver is selected then the Picomotor Driver Control Panel will be displayed, and if a Joystick module is selected the Joystick Control Panel will be displayed.
- When the DCN Utility is started for the first time, each of the modules will be programmed with default operating values during initialization. These default values will also be displayed in the various fields on the Control Panel.
- To exit the program, click on the Windows **X** or press the **Exit** button.

Note:

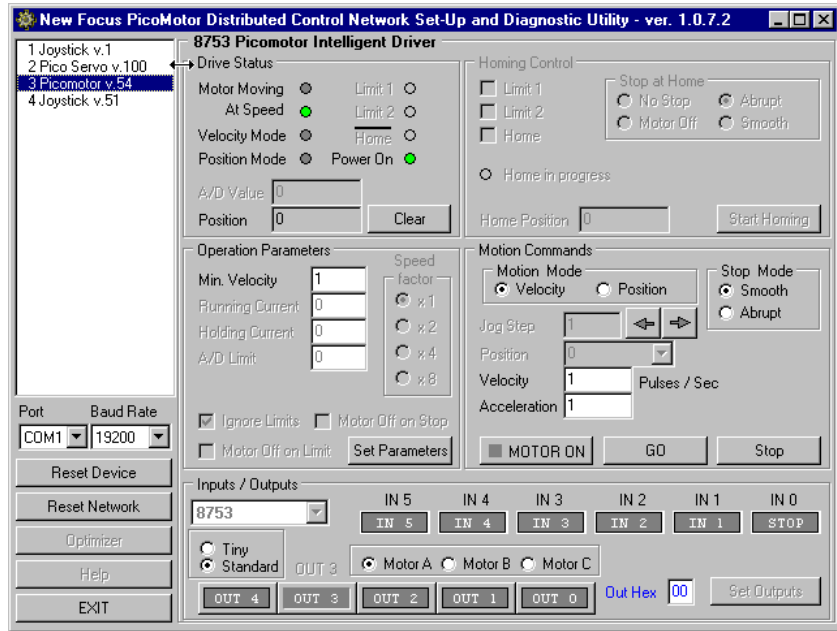
*On exit or re-initialization (when the **Reset Network** button is pressed) the operating parameters for all the modules will be saved in the "DCN.ini" file and the next initialization of the network will load those parameters. The user can also define custom sets of parameters in separate ".ini" files, which can be loaded by right clicking on the **Reset Network** button.*

Model 8753 Picomotor Driver Control Panel

The Picomotor Driver Control Panel, shown in Figure 24, is displayed when a Picomotor driver is selected from the module list displayed on the left side of the DCN Utility window.

The various options available on the Picomotor Driver Control Panel are described in the following sections. A typical sequence of steps that needs to be executed to achieve motion is described on page 108.

Figure 24:
Picomotor Driver
Control Panel



Drive Status Panel

The Drive Status panel gives information about the operating status as reported directly by the Picomotor driver. A green LED will be set in the following cases:

- Motor Moving: The motor is moving and is cleared otherwise.
- Power On: The motor power output signal is on.
- At Speed: The commanded velocity is reached.
- Velocity Mode: The motor is moving in velocity mode.
- Position Mode: The motor is moving in position (trapezoidal) mode.

Position

The Position represents the state of the 32-bit internal position counter, which indicates the number of pulses output since the last time the counter was reset. The position counter has a range of $\pm 2,147,483,647$ steps.

The counter is reset to zero during power-up, when the program is first loaded, or if the **Clear** or **Reset Device** buttons are pressed. The Position can be reset to zero only when the motor is not in motion.

Operation Parameters Panel

The Operation Parameters panel allows the user to specify the minimum velocity. This value should always be less than or equal to the Velocity value specified in the Motion Commands panel (see below). The units of the Min. Velocity are Hz (pulses/second), and the range of allowed values is 0 to 2000 Hz.

Motion Commands Panel

The Motion Commands panel allows the user to specify motion parameters and to start and stop a Picomotor. The various parameters are defined below.

Motion Mode

In “Position” mode, the motor moves with a calculated trapezoidal velocity trajectory from its starting position to the target position. The range of position in motor steps (or pulses) is $\pm 2,147,483,647$. The specified Acceleration will be used, and the specified Velocity will not be exceeded. The target Position can either be an absolute signed (+ve or -ve) position entered in the Position field and initiated by the **GO** button, or a relative position entered in the Jog Step field, with the \rightarrow (forward or CW) or \leftarrow (backward or CCW) buttons used to define direction and initiate motion.

In “Velocity” mode, the velocity profiler is used to accelerate or decelerate the motor from its Min. Velocity to the specified target Velocity, which can be positive or negative. To change the Velocity value, a stop command must first be issued by pressing the **Stop** button. Velocity values less than the Min. Velocity, as defined in the Operation Parameters panel, will not be accepted.

Stop Mode

If the Stop Mode is set to “Smooth,” then upon pressing the **Stop** button, the motor will decelerate to a stop at the specified acceleration

rate. If the Stop Mode is set to “Abrupt,” the motor will stop immediately at its current position when the **Stop** button is pressed. The Stop mode is only applicable in the Velocity Motion Mode.

Jog Step

Available only in the Position Motion Mode, the Jog Step acts as a relative-move command. The number of pulses can be entered in the text field, and the left and right arrows next to it can be used to initiate the motion in CW (forward) and CCW (backward) direction, respectively. The arrows do not need to be held down once the motion has started. The units are pulses and the range is $\pm 2,147,483,647$ pulses.

Position

The Position field is also available only in the Position mode. It indicates the absolute position to move to with the **GO** button. The units are pulses with a range of $\pm 2,147,483,647$ pulses.

Velocity

The Velocity field is applicable to both the Position and Velocity Modes and indicates the peak velocity in both cases. The units are Hz (pulses/second), with a range of 1 to 2000 Hz. The Velocity cannot be smaller than the Min. Velocity value.

Note:

The Velocity value is internally transformed to an 8-bit velocity number in conjunction with a speed factor. As a result, in some cases, the resultant velocity will be close to but not exactly equal to the user-defined velocity value. For example, velocity values of 2000 or 1000 Hz will result in exactly the specified pulse output frequencies, but velocity values of 1900 or 1100 will result in slightly different pulse output frequencies.

Acceleration

This is an acceleration factor, with a range of 1 to 255, which is used to determine both acceleration and deceleration in both the Position and the Velocity modes. The actual acceleration time can be calculated based upon the equations defined in “The diagnostic information is different depending on whether or not the Servo is enabled (defined by ENABLE_SERVO bit of mode sent to ServoLoadTraj (), and possibly reset by ServoStopMotor ().” on page 187.

MOTOR ON

The **MOTOR ON** button turns the driver amplifier on or off. If the amplifier is on, first a stop command is sent to the Picomotor drive to stop the motor in the specified manner and then the amplifier is disabled. If the amplifier is off, this button turns the amplifier on.

GO Button

The **GO** button is used to start the motion after the relevant parameters have been defined. This button is used in Velocity mode and absolute Position mode (using the Position text field, not the Jog Step field).

Stop Button

The **Stop** button will send the Picomotor drive a stop command for the selected stopping mode. The amplifier is kept enabled. This button is typically used only in Velocity Mode; in Position Mode, the motion will automatically stop once the specified number of pulses has been sent to the Picomotor. However, if the **Stop** button is pressed in the middle of a move in Position Mode, the motion will stop immediately without having reached the target position.

Other Information

Other information, such as the time for motion in Position Mode with absolute move and the acceleration time, are also displayed. The time is reset to 0 after the target position has been reached.

Inputs/Outputs Panel

The Inputs/Outputs panel lets the user select the motor channel for the currently selected driver, along with the type of Picomotor—Tiny or Standard—connected to that channel.

The motor type or channel can be changed only when the driver is off. If the driver is on, press **MOTOR ON** to switch it off.

The Inputs/Outputs panel also displays some of the input byte and IO byte bits for your reference.

Typical Operation Sequence

A typical sequence of steps that needs to be executed to achieve motion, after the network has been successfully initialized, is listed below:

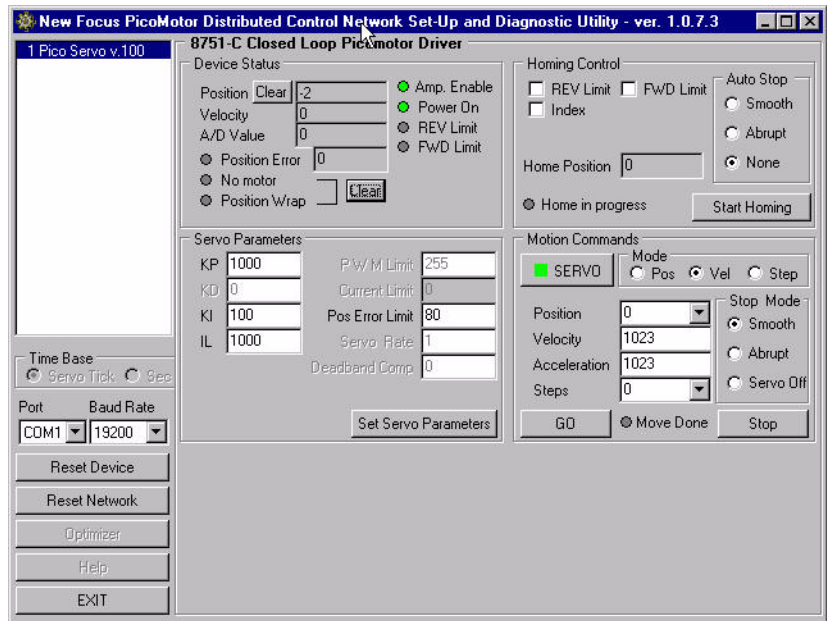
1. Select a particular Picomotor driver from the module list displayed on the left side of the DCN Utility window.
2. Choose the motor channel (e.g., Motor A) and motor type (e.g., Standard) in the Inputs/Outputs panel.
3. Set Min. Velocity (e.g., 1) in the Operations Parameters panel.
4. In the Motion Commands panel:
 - Choose the Motion Mode (e.g., Velocity).
 - Select the Stop Mode (e.g., Smooth).
 - Type a Velocity value (e.g., 1000 pulses/sec).
 - Type an Acceleration factor value (e.g., 255).
5. Press **Clear** (in the Drive Status panel) to reset the position to 0.
6. Press **MOTOR ON** (in the Motion Command panel).
7. Press **GO**. The motor will start moving and the pulse count will be shown in the Position field in the Drive Status panel.
8. Press **Stop** to stop motion. The total number of pulses output is indicated in the Position field in the Drive Status panel.

Model 8751-C Closed-Loop Driver Control Panel

The Closed-Loop Driver Control Panel, shown in Figure 25, is displayed when a closed-loop driver is selected from the module list displayed on the left side of the DCN Utility window.

The various options available on the Closed-Loop Driver Control Panel are described in the following sections.

Figure 25: Closed-Loop Driver Control Panel



Device Status Panel

The Device Status panel gives information about the operating status as reported directly by the closed-loop driver, including:

- Position: Current position in encoder counts (63.5 nm per count).
- Clear: Pushbutton to reset current position to zero.
- Velocity: estimate of current velocity in counts/tick.
- A/D Value: Value of A/D input.
- Position error: Value and status light—current difference between commanded and actual encoder count.
- No Motor: Lights if servo is enabled or motion is commanded when no motor is present.
- Position Wrap: Set if the 32-bit position counter over-runs.
- Amp Enable: Motor on status. Green light is normal. Amp can be disabled by cycling the SERVO button in the Motor Commands panel. When Amp is disabled, status lights display bits from the

driver Status Byte. Re-enabling SERVO will return driver to Amp Enable, normal status.

- Power On: Driver power status. Green light is normal.
- REV Limit: Green light is normal, limit not activated.
- FWD Limit: Green light is normal, limit not activated.

Servo Parameters Panel

The Servo Parameters Panel allows you to enter the following settings:

- KP: 1-32,767. Proportional gain for position holding. 1000 is a typical value.
- KI: 1-32,767. Integrator gain for position holding. Primarily used to detect stalled motor by generating an over current error when commanded motor motion is not occurring. 100 is a typical value.
- IL: 1-32,767. Maximum value of integrator gain which will be applied to driver motor position. 1000 is a typical value.
- Pos Error Limit: 1-16,893. Value beyond which servo will disable. Position error indicates stalled motor which cannot reach target, or disturbance beyond position error limit.
- Set Servo Parameters: Stores newly entered parameters into flash memory.

Homing Control Panel

The following options can be set in the Homing Control Panel

- REV Limit
- FWD Limit
- Index
- Auto Stop (Smooth, Abrupt, None)
- Home Position
- Start Homing, Home in Progress

Motion Commands Panel

The Motion Commands Panel is used to set the following motion commands for the closed-loop driver:

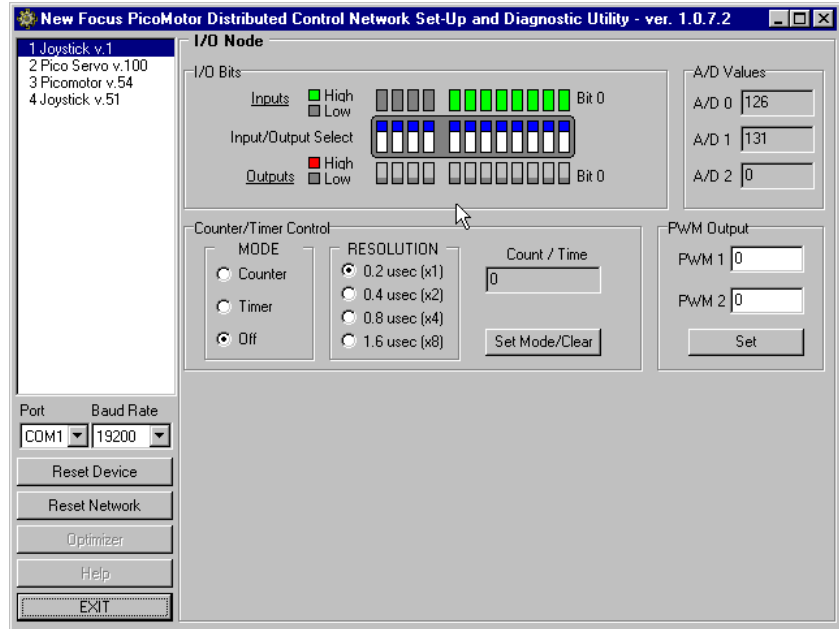
- SERVO: Place driver into/out of closed-loop mode.
- Mode (Pos, Vel, Step): Command motions by position, velocity, or individual motor pulses.
- Position: commanded position, executed on GO.
- Velocity: -1023 to 1023. Commanded velocity, executed on GO. Motor pulse frequency will be approximately $2 \text{ kHz} * \text{velocity} / 1023$. Applies in POS or VEL mode, also applies to homing commands.
- Acceleration: 0 to 1023.
- Steps: -255 to 255. Number of motor pulses to send in STEP mode.
- Stop Mode (Smooth, Abrupt, Servo Off): Only applies when STOP button is pushed. POS moves which reach their target stop at that target. Smooth causes moves to use the acceleration value on STOP. Abrupt causes move to STOP immediately, without deceleration. Servo Off causes move to stop immediately, and enter open-loop mode when STOP is pressed.
- GO: Starts motion.
- STOP: Halts motion using selected stop mode.
- Move Done: Indicates successful completion of a move or receipt of STOP. In Velocity mode, light returns to Green after target velocity is reached, acceleration profile is completed.

Joystick Control Panel

The Joystick v.1 Control Panel, shown in Figure 26, is displayed when the Joystick v.1 is selected from the module list displayed on the left side of the DCN Utility window.

The various options available on the Joystick Control Panel are described in the following sections.

Figure 26: Joystick Control Panel



I/O Bits Panel

The I/O Bits panel lets the user view the state of the input bits and set the value of the output bits.

Viewing Input Bits

The row of LED indicators indicates the state of the input bit (red for set, white for clear).

Setting/Clearing Output Bits

The row of LED indicators below the input bits is used to set or clear an output bit. If the LED is white, the bit is clear (0 volts) and if the LED is red, the bit is set. Clicking on the output LED will toggle its value.

A/D Values Panel

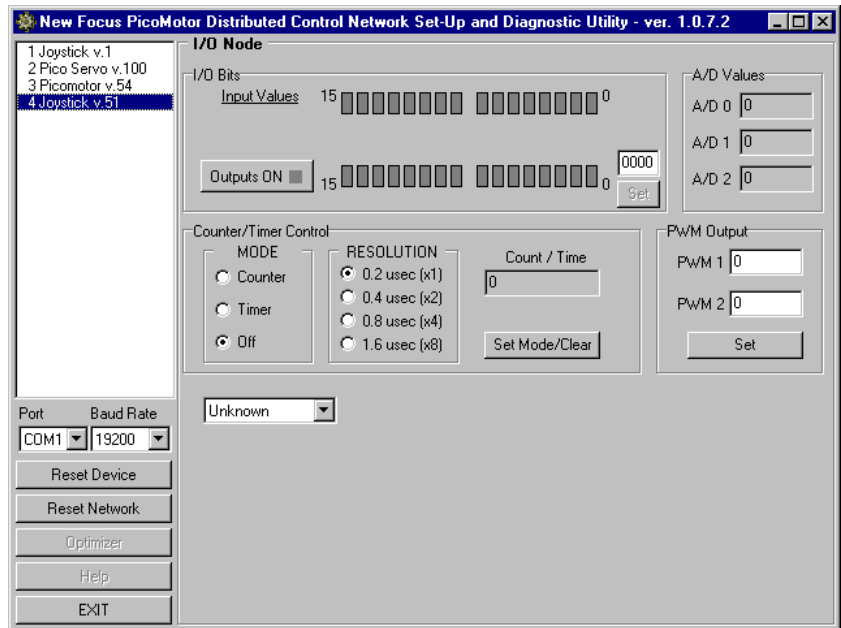
The A/D Values panel displays the values of the two 8-bit A/D input channels that correspond to the joystick X and Y axes positions. The values displayed are between 0 and 255 with approximately 127 being the middle of the range of motion of the joystick.

I/O Modules Control Panel

The Joystick v.51 (I/O Module) Control Panel, shown in Figure 27, is displayed when the Joystick v.51 is selected from the module list displayed on the left side of the DCN Utility window.

The various options available on the I/O Module Control Panel are described in the following sections.

Figure 27: Joystick Control Panel



I/O Bits Panel

The I/O Bits panel lets the user view/set the following values:

- Input Values
- Outputs (ON)
- Set pushbutton: Stores hex coded value from box above Set button into output bits.

A/D Values Panel

The A/D Values Panel shows the current value at each A/D input (A/D 0, A/D 1, and A/D 2), 8 bits, 0-32 V.

Counter/Timer Control Panel

The Counter/Timer Control panel offers the following settings:

- MODE (Counter, Timer, Off): Selects counter/timer mode. Counter causes count to increment whenever input bit 9 is raised high. Timer causes count to increment at specified resolution.
- RESOLUTION: Specifies the counter resolution.
- Count/Time: Current count or timer result.
- Set Mode/Clear: Reset counter/timer. New Mode becomes effective if changed.

PWM Output Panel

The PWM Output Panel shows the current output settings for each PWM output (PWM 1 and PWM 2), output bits 0, 1. 0-255.

Computer Control: Using DLLs

Overview

The DCN Function Library (LDCNLIB.DLL) is a dynamic link library of functions that can be used to develop custom applications for the New Focus Intelligent Picomotor drivers and joystick modules. This library file, along with sample programs in LabVIEW, Visual Basic and Visual C++, can be found on the New Focus web site. For C/C++ users, the DLL functions are all defined in a series of .H files. For LabVIEW users, the DLL functions are all contained in a single .LLB file.

LDCNLIB.DLL consists of three levels of functions.

- At the lowest level is the group of serial I/O functions listed in SIO_UTIL.H. These functions provide basic (non-overlapped) COM port support independent of the LDCN communication protocol. It includes functions for opening and closing COM ports, sending and receiving characters, etc. Typically, you will never need to call these functions directly. Documentation for these low-level commands is not included in this manual. Please contact New Focus for further information if you need to handle COM port addressing directly in your application.
- The next level of functions, listed in LDCNCOM.H, provide basic support of the LDCN communication protocol. The functions at this level are independent of the types of modules used. They include initialization and reset functions for the entire network of modules, module control functions common to all module types, and functions for retrieving data common to all module types.
- The last level of functions are those specific to particular types of modules. These are described in SERVO.H, IO.H and STEPPER.H.

They include functions for operations specific to each module type and functions for retrieving module-type specific data.

The following pages contain a summary of the second- and third-level commands, followed by detailed definitions for each command, including syntax, variables, and examples (in C++). Before you begin using the library, you may also want to read the “Computer Control: Global Definitions” chapter beginning on page 179.

Note: *The DLL library cannot be used with the Model 8750 Network Controller or Model 8752 Ethernet Controller.*

Using the RS-485 Interface

The host computer can communicate with the modules attached to a serial port by using an RJ-45 cable (with a DB-9/RJ-45 adapter) connected to the **Network In** connector of a joystick or driver. This cable and adapter are available in the optional New Focus Model 8761 Intelligent Picomotor Computer Interface Kit (see “Intelligent Picomotor Accessories” on page 19).

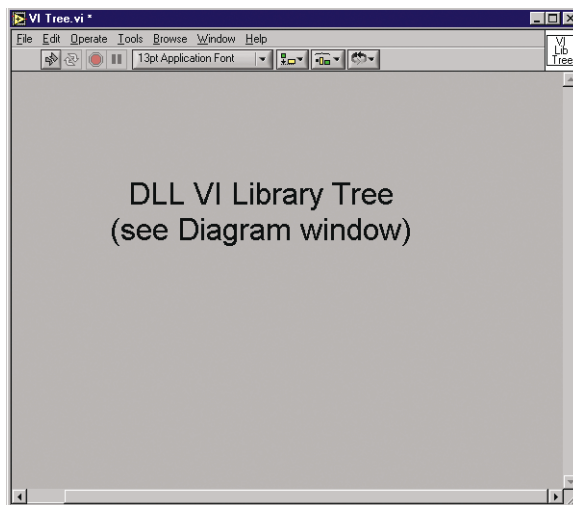
Note: *See “Using DLL/DCN with the Driver(s), I/O Module(s), and Joystick” on page 35 or “Using DLL/DCN with the Driver(s) Only” on page 32 for set-up instructions.*

Using the LabVIEW Interface

Overview of LabVIEW Drivers

The LabViewExample.llb VI library package contains VI versions of each of the DLL functions described in this manual. They are laid out for convenience in a simple tree diagram, shown in the “VI Tree vi Diagram” window. Each VI is set up to accept the proper parameter inputs and deliver the parameter outputs as described in the DLL documentation. We have also provided “Application.vi,” which is an example program written to utilize the DLLs for both open- and closed-loop driver control. You may use the application directly by embedding it into your own VI program, or by copying the sections relevant to you, such as the initialization block.

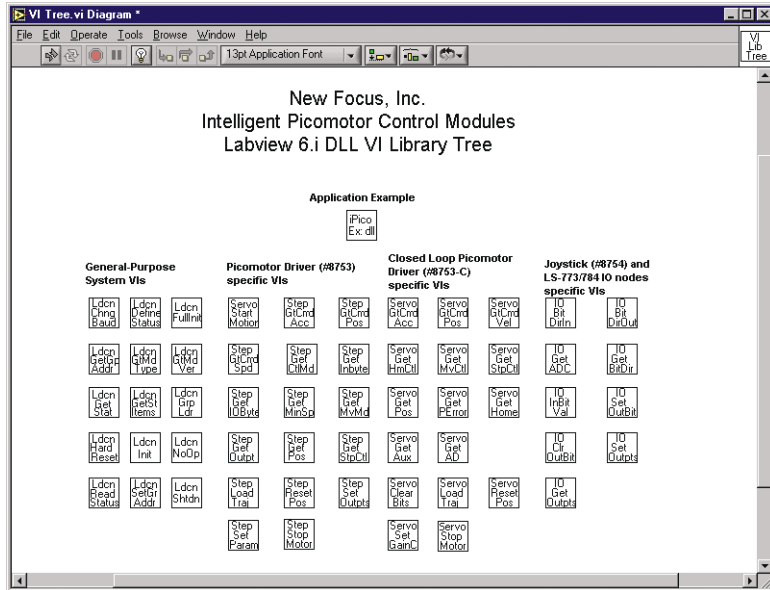
Figure 28:
LabVIEW VI Tree vi
window



Navigating the Example

If you double-click the LabViewExample.llb to launch LabVIEW, the blank window shown above (Figure 28). will appear. Click Window ->Show Diagram to see the “VI Tree vi Diagram” shown in Figure 29.

Figure 29:
LabVIEW VI Tree vi
Diagram window



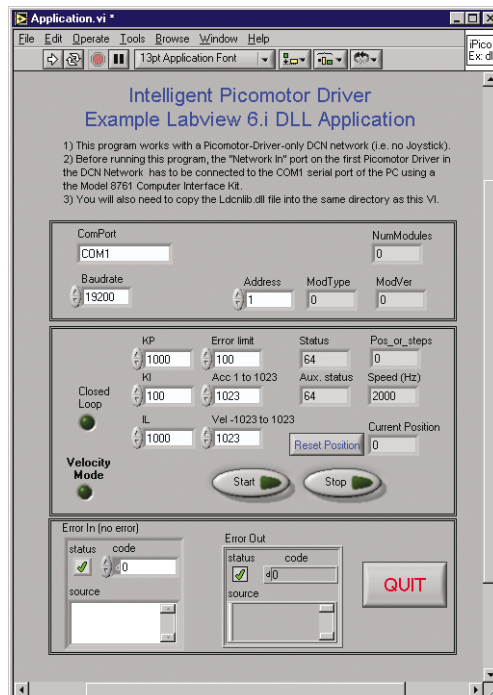
From the tree diagram, double-click the “iPicoEx.dll” block to open the example VI panel. This should be an executable VI window. The example contains programming notes and comments for those who wish to modify it. It performs the following functions:

1. Initializes the RS-485 network, attached to the button-selected COM port (remember to use a Model 8722 RS-232 to RS-485 communication adapter).
2. Counts and catalogs the number of Model 8753 and 8751-C modules in the network (display by Address as NumModules, ModType, ModVer).
3. Depending on the RS-485 address selected, the middle section of the VI panel displays either open- or closed- loop control buttons and status information. Moves can be programmed using the control buttons, and the Start/Stop buttons can be used to execute the moves.
4. If the selected address corresponds to a Model 8751-C closed-loop driver, the different motion modes (closed-loop or open-loop, velocity or position mode) are displayed in the status lights at the left of the panel. The mode can be toggled by pushing the status

light button, which will expose or hide different motion parameters.

5. As the VI executes, it performs a loop, checking and displaying the status of the drivers, reading and programming the motion profile, starting or stopping the motion, and repeating.
6. Network or communication errors will be flagged in the lower section of the VI panel.
7. For proper RS-485 network performance, it is important to exit the VI using the QUIT button in the lower section of the VI panel. The QUIT button causes LabVIEW to exit in a way which properly unblocks the COM port. Otherwise, subsequent programs may not be able to access the COM port.

Figure 30:
LabVIEW
Application
Diagram window



Programming for the Driver(s), I/O Module(s), and Joystick

When programming for the driver(s), I/O module(s) and joystick, keep the following rules in mind:

- Modules are assigned an address upon network initialization. The first device in the daisy-chain receives address 0x01.
- The host dynamically sets the address of each device with the aid of the daisy-chained **Network In** and **Network Out** lines. The first module in the network is assigned the default address of 0x00.
- Each Model 8753 open-loop driver can support up to three motors; the Model 8751-C drivers only support one motor.
- The joystick has four digital inputs (buttons numbered 0 to 3) and eight digital outputs (LEDs numbered 0 to 7). The analog inputs are expressed in (x,y) coordinates of the joystick axes.

Note:

See the “Computer Control: Global Definitions” chapter beginning on page 179 for additional information about addressing, byte descriptions, and more.

Note:

All of the “.h” files referred to in the examples are available on the New Focus web site along with the C++ example.

Conventions

The following conventions are used in both the “Command Summary” and the “Command Definitions” sections.

- The commands are case sensitive.
- Function parameters are shown in parentheses ().
- Return values appear before the command.

For example, in the command

```
num_modules = LdcnFullInit(*portname, baudrate)
```

`num_modules` is the return variable, `LdcnFullInit` is the command, and `*portname` and `baudrate` are the function parameters. The variable data types are explained in the table on the next page.

Parameter Data Types

Every command definition has an argument/parameter table and a response table that list the data types for each parameter. The primary types and their ranges are described in the table below.

Type	Description	Range	C/C++	Visual BASIC
bool	Boolean	0, 1	BOOL	Boolean
u8	8-bit ASCII character	0 to 255	Char	Not supported by BASIC. For functions that require character arrays, use string types instead.
i16	16-bit signed integer	-32,768 to 32,767	Short	Integer
u16	16-bit unsigned integer	0 to 65,535	Unsigned short for 32-bit compilers.	Not supported by BASIC. For functions that require unsigned integers, use the signed integer type instead. See the i16 description.
i32	32-bit signed integer	-2,147,483,648 to 2,147,483,647	Long	Long
u32	32-bit unsigned integer	0 to 4,294,967,295	Unsigned long	Not supported by BASIC. For functions that require unsigned long integers, use the signed long integer type instead. See the i32 description.
f32	32-bit single-precision floating point	-3.402823×10^{38} to 3.402823×10^{38}	Float	Single
f64	64-bit double-precision floating point	$-1.797683134862315 \times 10^{308}$ to $1.797683134862315 \times 10^{308}$	Double	Double

Command Summary

Common Commands

Command	Description	Page
LdcnChangeBaud	Change Baud Rate	125
LdcnDefineStatus	Define Status Data	135
LdcnFullInit	Full-Initialize Modules	127
LdcnGetGroupAddr	Query Group Address	127
LdcnGetModType	Query Module Type	128
LdcnGetModVer	Query Firmware Version	135
LdcnGetStat	Get Status	129
LdcnGetStatItems	Get Status Items	130
LdcnGroupLeader	Query Group Leader	130
LdcnHardReset	Reset Modules	135
LdcnInit	Initialize Modules	132
LdcnNoOp	Issue No Operation Command	133
LdcnReadStatus	Query Status Data	134
LdcnSetGroupAddr	Set Group Address	135
LdcnShutdown	Shutdown Module	135

Open-Loop Picomotor Driver Commands

Command	Description	Use While Moving?	Page
ServoStartMotion	Start Motion	Yes (only in vel. mode)	136
StepGetCmdAcc	Query Command Acceleration	Yes	137
StepGetCmdPos	Query Command Position	Yes	142
StepGetCmdSpeed	Query Command Velocity	Yes	138

Command	Description	Use While Moving?	Page
StepGetCtrlMode	Query Control Mode	Yes	138
StepGetInbyte	Query Input Byte	Yes	139
StepGetIObyte	Query I/O Byte	Yes	139
StepGetMinSpeed	Query Minimum Velocity	Yes	140
StepGetMvMode	Query Motion Mode	Yes	140
StepGetOutputs	Query State of Outputs	Yes	141
StepGetPos	Query Motor Position	Yes	141
StepGetStopCtrl	Query Control Mode	Yes	142
StepLoadTraj	Load Motion Trajectory	Yes (only in vel. mode)	143
StepResetPos	Reset Position	No	145
StepSetOutputs	Set Outputs	No	146
StepSetParam	Set Motion Parameters	No	147
StepStopMotor	Stop Motor	Yes	148

Closed-Loop Picomotor Driver Commands

Command	Description	Page
ServoClearBits	Clear Status Bits	149
ServoGetAD	Query A/D Value	149
ServoGetAux	Query Auxiliary Status	150
ServoGetCmdAcc	Query Command Acceleration	150
ServoGetCmdPos	Query Command Position	151
ServoGetCmdVel	Query Command Velocity	151
ServoGetGain	Query Gain Values	152
ServoGetHome	Query Motor Home Position	153
ServoGetHomeCtrl	Query Home Control Byte	153

Command	Description	Page
ServoGetMoveCtrl	Query Move Mode Control Byte	154
ServoGetPErr	Query Position Error	154
ServoGetPos	Query Motor Position	155
ServoGetStopCtrl	Query Stop Mode Control Byte	155
ServoLoadTraj	Load Motion Trajectory	156
ServoResetPos	Reset Encoder	157
ServoSetGain	Set Gain Values	158
ServoSetHoming	Set Homing Conditions	159
ServoStartMotion	Start Motion	136
ServoStopMotor	Stop Motor	160

I/O Module and Joystick Commands

Command	Description	Page
IoBitDirIn	Set Line to Input	161
IoBitDirOut	Set Line to Output	167
IoClrOutBit	Turn Off Output	162
IoGetADCVal	Query A/D Value	163
IoGetBitDir	Query I/O Line	167
IoGetOutputs	Query Output Value	164
IoGetPWMVal	Query PWM Value	164
IoGetTimerMode	Query Timer Mode	165
IoGetTimerSVal	Query Synchronous Timer/Counter Value	165
IoGetTimerVal	Query Timer/Counter Value	166
IoInBitSVal	Query Synchronous Input Value	166
IoInBitVal	Query Input Value	167
IoOutBitVal	Query Output Value	167

Command	Description	Page
IoSetOutBit	Turn On Output	168
IoSetOutputs	Set Output Values	167
IoSetPWMVal	Set PWM Value	169
IoSetSynchOutput	Set Future Output and PWM Values	170
IoSetTimerMode	Set Timer/Counter Mode	170
IoSynchOutput	Synchronous Output	171
LdcnSynchInput	Synchronous Input	171

Command Definitions

Common Commands

Change Baud Rate

Syntax `result = LdcnChangeBaud(groupaddr, baudrate)`

Arguments/
Parameters

Name	Type	Description
groupaddr	u8	Group address of modules to be changed
baudrate	u16	Allowed values are 9600, 19200, 57600 and 115200

Definition

Changes the baud rate of all modules with group address `groupaddr` and also changes host's baud rate. Should include all modules. A status packet returned from this command would be at the new baud rate, so typically (unless the host's baud rate can be accurately synchronized) there should be no group leader when this command is issued.

Response

Name	Type	Description
result	bool	True (1) on success; false (0) on failure.

Define Status Data

Syntax `result = LdcnDefineStatus(addr, statusitems)`

Arguments/
Parameters

Name	Type	Description
addr	u8	Address of module
statusitems	u8	Status items to be sent back. The Define Status Items Byte descriptions can be found in Computer Control: Global Definitions beginning on page 179; it includes references to closed-loop and open-loop drivers, and I/O modules.

Definition

For module(s) at address `addr`, defines which status data will be sent back with each command.

Note: The Picomotor driver reports the current position of the motor multiplied by 25. The control system (host) should divide this value by 25 to obtain the actual number of steps.

Response

Name	Type	Description
result	bool	True (1) on success; false (0) on failure

Example

For open-loop driver only: To set bits 0, 3, 5, and 6, `statusitems = 0x69` or `statusitems` can be set to bitwise OR of the following: `0x01` (SEND_POS), `0x08` (SEND_INBYTE), `0x20` (SEND_ID), and `0x40` (SEND_OUT). The corresponding constants in parentheses are defined in the example STEPPER.H file.

For closed-loop driver only: To set bits 0 and 4, `statusitems=0x11` or `statusitems` can be set to bitwise OR of the following: `0x01` (SEND_POS) and `0x10` (SEND_HOME). The corresponding constants in parenthesis are defined in the example SERVO.H file.

For joystick or I/O modules only: To set bits 0, 1, and 2, `statusitems = 0x07` or `statusitems` can be set to bitwise OR of the following: `0x01` (SEND_INPUTS), `0x20` (SEND_AD1), and `0x40` (SEND_AD2). The corresponding constants in parentheses are defined in the example IO.H file.

Full-Initialize Modules

Syntax `num_modules = LdcnFullInit(*portname, baudrate)`

Arguments/
Parameters

Name	Type	Description
*portname	u8	Computer port used to connect to the modules. Possible values are COM1, COM2, COM3, or COM4.
baudrate	u16	Allowed values are 9600, 19200, 57600, and 115200.

Definition

When the network is left at a baud rate different than 19200, the modules will not recognize `LdcnHardReset()` command and `LdcnInit()` will not be able to initialize the network. `LdcnFullInit()` works exactly as `LdcnInit()` sequentially at different baud rates (19200, 9600, 57600 and 115200).

Response

Name	Type	Description
num_modules	i16	The number of modules found on the network

Example

See lines 40–54 of the C++ Example beginning on page 172.

Query Group Address

Syntax `groupaddr = LdcnGetGroupAddr(addr)`

Arguments/
Parameters

Name	Type	Description
addr	u8	Address of module

Definition

Returns the group address of a particular module.

Response

Name	Type	Description
groupaddr	u8	Group address of module

Query Module Type

Syntax `mod_type = LdcnGetModType (addr)`

Arguments/
Parameters

Name	Type	Description
addr	u8	Address of module

Definition

Returns the module type of a particular module.

Note: This data is only valid if bit 5 of the define status items byte for the module (see Computer Control: Global Definitions beginning on page 179 for byte descriptions) has been set in the last `LdcnDefineStatus ()` or `LdcnReadStatus` function call.

Response

Name	Type	Description
mod_type	u8	Type of Module (joystick or driver)

Example

See line 60 of the C++ Example beginning on page 172.

“3” = Open-loop Picomotor driver (STEPMODTYPE, as defined in the example LDCNCOM.H file)

“2” = Joystick or I/O module (IOMODTYPE, as defined in the example LDCNCOM.H file).

“0” = Closed-loop picomotor driver (SERVOMODTYPE, as defined in the example LDCNCOM.H file).

Query Firmware Version

Syntax `mod_version = LdcnGetModVer (addr)`

Arguments/
Parameters

Name	Type	Description
addr	u8	Address of module

Definition

Returns the firmware version number of a particular module.

Note: This data is only valid if bit 5 of the define status items byte for the module (see Computer Control: Global Definitions beginning on page 179 for byte descriptions) has been set in the last `LdcnDefineStatus ()` or `LdcnReadStatus` function call.

Response

Name	Type	Description
mod_version	u8	Firmware version of the module. It will be in the range of 50 to 59.

Example

See line 61 of the C++ Example beginning on page 172.

Get Status

Syntax `status = LdcnGetStat (addr)`

Arguments/
Parameters

Name	Type	Description
addr	u8	Address of module

Definition

Returns the last status byte of module at address `addr`.

The value of `status` is always stored in the host, so to ensure a valid status, a command needs to be sent to the `addr` in question (which results in an update of the status value). One way to update the status value without causing any unwanted system changes is the `LdcnNoOp` function.

For status byte descriptions, see Computer Control: Global Definitions beginning on page 179.

Response

Name	Type	Description
status	u8	Last status byte of the module

Get Status Items

Syntax `statusitems = LdcnGetStatItems (addr)`

Arguments/
Parameters

Name	Type	Description
addr	u8	Address of module

Definition

Returns the byte specifying the default status items to be returned in the status data packet—the most recently sent parameter of the `LdcnDefineStatus ()` function. The detailed description of the individual bits of the define status items byte varies by module type. See *Computer Control: Global Definitions beginning on page 179 for byte descriptions.*

Response

Name	Type	Description
statusitems	u8	Default status items to be returned in the status data packet

Query Group Leader

Syntax `result = LdcnGroupLeader (addr)`

Arguments/
Parameters

Name	Type	Description
addr	u8	Address of module

Definition

Returns whether specified module is a group leader or not.

Response

Name	Type	Description
result	bool	True (1) if specified module is group leader, false (0) if not

Reset Modules

Syntax `result = LdcnHardReset()`

Definition Resets all modules to their power-up state. Under almost all circumstances, this is issued to a group address (0xFF) including all control modules. Cleans up the internal data structure and resets the COM port's baud rate to the default value of 19200.

Response

Name	Type	Description
result	bool	True (1) on success; false (0) on failure

Initialize Modules

Syntax `num_modules = LdcnInit(*portname, baudrate)`

Arguments/
Parameters

Name	Type	Description
*portname	u8	Computer port used to connect to the modules. Possible values are COM1, COM2, COM3, or COM4.
baudrate	u16	Allowed values are 9600, 19200, 57600, and 115200

Description

Initializes all modules on the LDCN network with unique sequential addresses starting at 1 and establishes their device types. All modules are assigned a group address of 0xFF.

Opens COM port at 19200 baud, initializes all devices using 19200 baud, then sets baud rate to baudrate parameter value.

Sends a `LdcnHardReset()` command to group address 0xFF (default), and sets baud rate for all devices.

Response

Name	Type	Description
num_modules	i16	The number of modules found on the network

Example

See line 41 of the C++ Example beginning on page 172.

Issue No Operation Command

Syntax `result = LdcnNoOp(addr)`

Arguments/
Parameters

Name	Type	Description
addr	u8	Address of module

Definition

Does nothing except cause a status packet with the currently defined status data to be returned. The status byte can then be read back with a `LdcnGetStat()` function call.

Response

Name	Type	Description
result	bool	True (1) on success; false (0) on failure

Example

See lines 87–90 and 126–129 of the C++ Example beginning on page 172.

Query Status Data

Syntax `result = LdcnReadStatus(addr, statusitems)`

Arguments/
Parameters

Name	Type	Description
addr	u8	Address of module
statusitems	u8	Status items to be sent back. The define status items byte are described in Computer Control: Global Definitions beginning on page 179.

Definition

Reads status data from a module without changing the default status data. Thus, this is a non-permanent version of the `LdcnDefineStatus()` command.

The status packet returned in response to this command will incorporate the data bytes specified, but subsequent status packets will include only the data bytes previously specified with the `LdcnDefineStatus()` command. The individual bits in the define status items byte and the method to set them are defined in the description of the `LdcnDefineStatus()` command.

Note: The Picomotor driver reports the current position of the motor multiplied by 25. The control system (host) should divide this value by 25 to obtain the actual number of steps.

Response

Name	Type	Description
result	bool	True (1) on success; false (0) on failure.

Example

See lines 59, 106–107, and 148 of the C++ Example beginning on page 172.

Set Group Address

Syntax `result = LdcnSetGroupAddr (addr, groupaddr, leader)`

Arguments/
Parameters

Name	Type	Description
addr	u8	Address of module.
groupaddr	u8	Group address of a module. Valid addresses are between 0x80 and 0xFF. The initial value is 0xFF.
leader	bool	Each group address has one leader. True (1) to set specified module to be group leader, false (0) if not.

Definition Sets the group address of a module.
Designates a group leader.

Response

Name	Type	Description
result	bool	True (1) on success; false (0) on failure

Shutdown Module

Syntax `LdcnShutdown ()`

Definition Cleans up the internal data structure, resets all LDCN modules to their power-up state by sending `LdcnHardReset ()` command, and closes previously opened COM port.

Example See lines 79 and 160 of the C++ Example beginning on page 172.

Open-Loop Picomotor Driver Commands

Start Motion

Syntax `result = ServoStartMotion(groupaddr)`

Arguments/
Parameters

Name	Type	Description
groupaddr	u8	Group address of drivers to be defined

Definition

Causes the trajectory information loaded with the most recent `StepLoadTraj()` or `ServoLoadTraj()` function call to be executed. This is useful for loading several drivers with trajectory information and then starting them simultaneously with a group command. This can be a valid group address or any individual address as well.

Note: The drivers must be in velocity mode to use this command when the Picomotor is moving.

Note: This command starts motion on both open- and closed-loop drivers.

Response

Name	Type	Description
result	bool	True (1) on success; false (0) on failure

Example

See lines 137–143 of the C++ Example beginning on page 172.

Query Command Acceleration

Syntax `acc = StepGetCmdAcc(addr)`

Arguments/
Parameters

Name	Type	Description
addr	u8	Address of module

Definition

Returns the commanded acceleration used in the last `StepLoadTraj ()` function call in position or velocity mode.

Response

Name	Type	Description
acc	u8	Acceleration used in last <code>StepLoadTraj ()</code> command

Query Command Position

Syntax `pos = StepGetCmdPos(addr)`

Arguments/
Parameters

Name	Type	Description
addr	u8	Address of module

Definition

Returns the commanded position used in the last `StepLoadTraj ()` function call in position mode.

Note: The device reports the current position of the motor multiplied by 25. The control system (host) should divide this value by 25 in order to obtain the actual number of steps.

Response

Name	Type	Description
pos	i32	Position used in last <code>StepLoadTraj ()</code> command

Query Command Velocity

Syntax `speed = StepGetCmdSpeed(addr)`

Arguments/
Parameters

Name	Type	Description
addr	u8	Address of module

Definition

Returns the commanded velocity used in the last `StepLoadTraj()` function call in position or velocity mode.

Response

Name	Type	Description
speed	u8	Speed used in last <code>StepLoadTraj()</code> command

Query Control Mode

Syntax `mode = StepGetCtrlMode(addr)`

Arguments/
Parameters

Name	Type	Description
addr	u8	Address of module

Definition

Returns the mode control byte used in the last `StepSetParam()` function call.

Response

Name	Type	Description
mode	u8	Bit definitions for mode are listed under <code>StepSetParam()</code> function.

Query Input Byte

Syntax `inbyte = StepGetInbyte (addr)`

Arguments/
Parameters

Name	Type	Description
addr	u8	Address of module

Definition

Returns the input byte value of an open-loop Picomotor driver. See Computer Control: Global Definitions beginning on page 179 for driver input byte description.

Note: This data is only valid if bit 3 of the Define Status Items byte (page 184) has been set in the last `LdcnDefineStatus ()` or `LdcnReadStatus ()` function call to this module address.

Response

Name	Type	Description
inbyte	u8	Input byte value of Picomotor driver

Query I/O Byte

Syntax `IObyte = StepGetIObyte (addr)`

Arguments/
Parameters

Name	Type	Description
addr	u8	Address of module

Definition

Returns a byte containing the I/O state byte of an open-loop Picomotor driver. See page 186 for driver I/O state byte description.

Note: This data is only valid if bit 6 of the define status items byte (page 184) has been set in the last `LdcnDefineStatus ()` or `LdcnReadStatus ()` function call to this module address.

Response

Name	Type	Description
IObyte	u8	I/O state byte value of Picomotor driver

Query Minimum Velocity

Syntax `minspeed = StepGetMinSpeed(addr)`

Arguments/
Parameters

Name	Type	Description
addr	u8	Address of module

Definition

Returns the commanded minimum velocity used in the last `StepSetParam()` function call.

Response

Name	Type	Description
minspeed	u8	Minimum velocity used in last <code>StepSetParam()</code> command

Query Motion Mode

Syntax `mode = StepGetMvMode(addr)`

Arguments/
Parameters

Name	Type	Description
addr	u8	Address of module

Definition

Returns the mode control byte used in the last `StepLoadTraj()` function call.

Response

Name	Type	Description
mode	u8	Speed used in last <code>StepLoadTraj()</code> command. Bit definitions for mode are listed under <code>StepLoadTraj()</code> function.

Query State of Outputs

Syntax `outbyte = StepGetOutputs (addr)`

Arguments/
Parameters

Name	Type	Description
addr	u8	Address of module

Definition Returns the state of the outputs (channel select and motor type) set by the last `StepSetOutputs ()` function call.

Response

Name	Type	Description
outbyte	u8	State of outputs set by last <code>StepSetOutputs ()</code> command

Query Motor Position

Syntax `pos = StepGetPos (addr)`

Arguments/
Parameters

Name	Type	Description
addr	u8	Address of module

Definition Returns the current motor position of a Picomotor driver.

Note: This data is only valid if bit 0 of the define status items byte (page 184) has been set in the last `LdcnDefineStatus ()` or `LdcnReadStatus ()` function call.

Note: The device reports the current position of the motor multiplied by 25. The control system (host) should divide this value by 25 in order to obtain the actual number of steps.

Response

Name	Type	Description
pos	i32	Current motor position of driver

Example See lines 107–110 and 149 of the C++ Example beginning on page 172.

Query Control Mode

Syntax `mode = StepGetStopCtrl(addr)`

Arguments/
Parameters

Name	Type	Description
addr	u8	Address of module

Definition

Returns the mode control byte used in the last `StepStopMotor()` function call.

Response

Name	Type	Description
mode	u8	Mode control byte used in last <code>StepStopMotor()</code> command

Load Motion Trajectory

Syntax `result = StepLoadTraj(addr, mode, pos, speed, acc, steptime)`

Argument/
Parameters

Name	Type	Description
addr	u8	Address of module
mode	u8	Mode is the load trajectory control byte; individual bits are defined in the table below.
pos	i32	The position data (range 0x80000000 to 0x7FFFFFFF) is only used as the goal position in position profile mode. While the position may range from -0x80000000 to +0x7FFFFFFF, the goal position should not differ from the current position by more than 0x7FFFFFFF. The value sent to the device should be 25 times the desired target position. For example, if the current position is 0, in order to make 100 steps, the commanded position sent to the device should be 2500.
speed	u8	The speed data (range 1 to 250) is used as the goal velocity in velocity profile mode or as the maximum velocity in trapezoidal profile mode.
acc	u8	The acceleration data (range 1 to 255) is used in both trapezoidal and velocity profile mode.
steptime	u16	Steptime parameter should be set to 0.

The individual bits of the load trajectory control byte (mode) are defined as follows:

Bit	Weight	Description
0	1	Load position data
1	2	Load velocity data
2	4	Load acceleration data
3	8	Reserved; set to 0
4	16	Direction (0=positive, 1= negative)
5	32	Reserved; set to 0
6	64	Reserved; set to 0
7	128	Start motion now

Bit 4 indicates the velocity direction and is ignored in trapezoidal profile mode. Note that if bit 7 is set, the motion will begin immediately; if it is not set, the motion will be started when ServoStartMotion command is executed.

Definition

Loads motion trajectory information for a Picomotor driver.

Note: 1) The velocity should be greater than minimum profile velocity (see StepSetParam () command).

2) In velocity mode, to change the direction of motion, a stop command must first be issued before a velocity in the opposite direction is commanded.

3) The driver must be in velocity mode to use this command when the Picomotor is moving.

Response

Name	Type	Description
result	bool	True (1) on success; false (0) on failure.

Example

Thus, to set bits 0, 1, 2, 4 and 7: mode=0x97 or mode can be set to the bitwise OR of the following: 0x01 (LOAD_POS), 0x02 (LOAD_SPEED), 0x04 (LOAD_ACC), 0x10 (STEP_REV) and 0x80 (START_NOW), as defined in the example STEPPER.H file.

See lines 96–102 and 137–142 of the C++ Example beginning on page 172.

Reset Position

Syntax `result = StepResetPos(addr)`

Arguments/
Parameters

Name	Type	Description
addr	u8	Address of module

Definition

Resets the current position to 0.

Note: Do not issue this command while executing a position (trapezoidal) profile motion.

Response

Name	Type	Description
result	bool	True (1) on success; false (0) on failure

Example

See lines 131–132 of the C++ Example beginning on page 172.

Set Outputs

Syntax `result = StepSetOutputs(addr, outbyte)`

Arguments/
Parameters

Name	Type	Description
addr	u8	Address of module
outbyte	u8	Outbyte is the set output control byte; individual bits are defined in the table below.

The individual bits of the output control byte are as follows:

Bit	Weight	Description
0, 1	1, 2	00b = Motor A, 01b = Motor B, 10b = Motor C
2	4	OUT2 = reserved, set to 0
3	8	OUT3 = reserved, set to 0
4	16	OUT4 = 1 if motor is tiny Picomotor, 0 for standard
5	32	Reserved; set to 0
6	64	Reserved; set to 0
7	128	Reserved; set to 0

All bits are cleared after power-up or after issuing a `LdcnHardReset()` command. The states of OUT0-OUT4 are described in “Driver Motor Selector” on page 181.

Definition

Sets the values for the output bits. This function is used for selecting the channel (bits 0 to 3) and the motor type (bit 4). The motor channel and type can be changed only when the motor driver is disabled. This function should therefore be called after a `StepStopMotor()` command with bit 0 in mode control byte set to 0, which will disable the driver. After changing the selected channel and/or motor type, call `StepStopMotor()` with bit 0 in mode control byte set to 1 to enable the driver.

Response

Name	Type	Description
result	bool	True (1) on success; false (0) on failure

Example

See lines 84–85 and 123–124 of the C++ Example beginning on page 172.

Set Motion Parameters

Syntax `result = StepSetParam(addr, mode, minspeed, runcur, holdcur, thermlim, em_acc)`

Argument/
Parameters

Name	Type	Description
addr	u8	Address of module
mode	u8	Mode is the mode control byte; individual bits are defined in the table below.
minspeed	u8	Minspeed sets the minimum velocity.
runcur	u8	Running current; should be set to 0
holdcur	u8	Holding current; should be set to 0
thermlim	u8	Thermal limit; should be set to 0
em_acc	u8	Emergency acceleration; should be set to 0

The mode control byte's individual bits are defined as follows:

Bit	Weight	Description
0	1	Speed Factor ($00_b = 8x$, $01_b = 4x$, $10_b = 2x$, $11_b = 1x$)
1	2	
2	4	Reserved. Set to 1
3	8	Reserved. Set to 0
4	16	Reserved. Set to 0
5	32	Reserved. Set to 0
6	64	Reserved. Set to 0
7	128	Reserved. Set to 0

Definition Sets control parameters and limits governing the behavior of the motor. This command must be issued before any motion can be executed. Also sets minimum velocity.

Response

Name	Type	Description
result	bool	True (1) on success; false (0) on failure

Example

To set the speed factor to 2x, mode = 0x06, or mode can be set to the bitwise OR of the following: 0x02 (SPEED_1X), and 0x04 (IGNORE_LIMITS), as defined in the example STEPPER.H file. See lines 68–79 of the C++ Example beginning on page 172.

Stop Motor

Syntax `result = StepStopMotor(addr, mode)`

Argument/
Parameters

Name	Type	Description
addr	u8	Address of module
mode	u8	Mode is the stop control byte; individual bits are defined in the table below.

The stop control byte's individual bits are defined as follows:

Bit	Weight	Description
0	1	Turn motor on/off
1	2	Reserved.
2	4	Stop abruptly
3	8	Stop smoothly
4	16	Reserved; set to 0
5	32	Reserved; set to 0
6	64	Reserved; set to 0
7	128	Reserved; set to 0

If bit 0 of the stop control byte is set, the motor driver will be turned on (enabled). If bit 0 is cleared motor driver will be turned off (disabled), regardless of the state of the other bits. If bit 2 is set, the motor will stop moving abruptly. Setting bit 3 enters a more graceful stop mode—the motor will decelerate to a stop. Only one of bits 2 or 3 should be set at one time.

Definition Stops the motor in the manner specified by mode and enables/disables the driver.

Response

Name	Type	Description
result	bool	True (1) on success; false (0) on failure

Example

To set bits 0 and 3, mode=0x09, or mode can be set to the bit-wise OR of the following: 0x01 (STP_ENABLE_AMP) and 0x08 (STOP_SMOOTH), as defined in the example STEPPER.H file. See lines 68–79 of the C++ Example beginning on page 172.

Closed-Loop Picomotor Driver Commands

Clear Status Bits

Syntax `result = ServoClearBits(addr)`

Argument/
Parameters

Name	Type	Description
addr	u8	Address of module

Description

Clears the sticky status bits (missing motor and position error bits in the status byte and the position wrap and driver timer overrun bits in the auxiliary status byte) for a closed-loop driver. They will stay set unless cleared explicitly with this command.

Response

Name	Type	Description
result	bool	True (1) on success; false (0) on failure

Query A/D Value

Syntax `ADVal = ServoGetAD(addr)`

Argument/
Parameters

Name	Type	Description
addr	u8	Address of module

Definition

Returns the current A/D value of a closed-loop driver.

Note: This data is only valid if the SEND_AD bit of statusitems has been set in the most recently issued LdcnDefineStatus() function.

Response

Name	Type	Description
ADVal	u8	The A/D value of the current motor

Query Auxiliary Status

Syntax `aux = ServoGetAux(addr)`

Argument/
Parameters

Name	Type	Description
addr	u8	Address of module

Definition

Returns the current auxiliary status byte of a closed-loop driver. Refer to auxiliary status byte definition (see Computer Control: Global Definitions beginning on page 179).

Note: This data is only valid if the SEND_AUX bit of statusitems has been set in the most recently issued LdcnDefineStatus() function.

Response

Name	Type	Description
aux	u8	The current auxiliary status byte

Query Command Acceleration

Syntax `acc = ServoGetCmdAcc(addr)`

Arguments/
Parameters

Name	Type	Description
addr	u8	Address of module

Definition

Returns the most recently issued command acceleration for the closed-loop driver at specified addr.

Response

Name	Type	Description
acc	i32	Most recently issued command acceleration

Query Command Position

Syntax `pos = ServoGetCmdPos (addr)`

Arguments/
Parameters

Name	Type	Description
addr	u8	Address of module

Definition Returns the most recently issued command position for the closed-loop driver at addr.

Response

Name	Type	Description
pos	i32	Most recently issued command position

Query Command Velocity

Syntax `vel = ServoGetCmdVel (addr)`

Arguments/
Parameters

Name	Type	Description
addr	u8	Address of module

Definition Returns the most recently issued command velocity for the closed-loop driver at addr.

Response

Name	Type	Description
vel	i32	Most recently issued command velocity

Query Gain Values

Syntax `gain = ServoGetGain(addr, *kp, *kd, *ki, *il, *ol, *cl, *el, *sr, *dc)`

Arguments/
Parameters At time slice i (occurs every sr -th servo cycle),
 $vel_i = (pos_{(i-1)} - target\ pos) * kp + \max(il, \text{sum over } i(pos_{(i-1)} - target\ pos)) * ki$
 $vel_i > 1023$ triggers `position_error` condition
 $pos_i - target\ pos > el$ triggers `position_error` condition

Name	Type	Description
<code>addr</code>	u8	Address of module
<code>*kp</code>	i16	Position error gain
<code>*kd</code>	i16	Not used (returns 0)
<code>*ki</code>	i16	Integrator error gain
<code>*il</code>	i16	Limit on integrator value
<code>*ol</code>	u8	Not used (returns 255)
<code>*cl</code>	u8	Not used (returns 0)
<code>*el</code>	i16	Position error limit
<code>*sr</code>	u8	Servo rate multiplier (1 is fastest)
<code>*dc</code>	u8	Not used (returns 0)

Definition Returns the most recently issued servo gain values for a closed-loop driver.

Response

Name	Type	Description
<code>gain</code>	BOOL	True (1) on success; false (0) on failure

Query Motor Home Position

Syntax `home = ServoGetHome(addr)`

Arguments/
Parameters

Name	Type	Description
addr	u8	Address of module

Definition

Returns the current motor home position of a closed-loop driver.

Note: This data is only valid if the SEND_HOME bit of statusitems has been set in the most recently issued LdcnDefineStatus() function.

Response

Name	Type	Description
home	i32	Current motor home position

Query Home Control Byte

Syntax `homecntrl = ServoGetHomeCtrl(addr)`

Arguments/
Parameters

Name	Type	Description
addr	u8	Address of module

Definition

Returns the home mode control byte the most recently issued function ServoSetHoming() for a closed-loop driver.

Response

Name	Type	Description
homecntrl	u8	Home mode control byte

Query Move Mode Control Byte

Syntax `movecntrl = ServoGetMoveCtrl (addr)`

Arguments/
Parameters

Name	Type	Description
addr	u8	Address of module

Definition

Returns the move mode control byte of the most recently issued function `ServoLoadTraj ()` for a closed-loop driver.

Response

Name	Type	Description
movecntrl	u8	Move mode control byte

Query Position Error

Syntax `PError = ServoGetPError (addr)`

Arguments/
Parameters

Name	Type	Description
addr	u8	Address of module

Definition

Returns the current position error of a closed-loop driver.

Note: This data is only valid if the `SEND_PERROR` bit of `statusitems` has been set in the most recently issued `LdcnDefineStatus ()` function.

Response

Name	Type	Description
PError	i16	Current position error

Query Motor Position

Syntax `pos = ServoGetPos(addr)`

Arguments/
Parameters

Name	Type	Description
addr	u8	Address of module

Definition

Returns the current motor position of a closed-loop driver.
Note: This data is only valid if the SEND_POS bit of statusitems has been set in the most recently issued LdcnDefineStatus() function.

Response

Name	Type	Description
pos	i32	Current motor position

Query Stop Mode Control Byte

Syntax `stopcntrl = ServoGetStopCtrl(addr)`

Arguments/
Parameters

Name	Type	Description
addr	u8	Address of module

Definition

Returns the stop mode control byte of the most recently issued function ServoStopMotor() for a closed-loop driver.

Response

Name	Type	Description
stopcntrl	u8	Stop mode control byte

Load Motion Trajectory

Syntax `result = ServoLoadTraj(addr, mode, pos, vel, acc, pwm)`

Arguments/
Parameters

Name	Type	Description
addr	u8	Address of module
mode	u8	Load trajectory control byte. Should be set to the bitwise OR of the trajectory control byte bits defined in SERVO.H.
pos	i32	Position of driver
vel	i32	Velocity of the driver
acc	i32	Acceleration of the driver
pwm	u8	PWM value of the driver. Should always be set to 0.

The mode byte's individual bits are defined as follows:

Bit	Weight	Description
0	1	Load position data (otherwise previously set pos is used)
1	2	Load velocity data (otherwise previously set vel is used)
2	4	Load acceleration data (otherwise previously set acc is used)
3	8	Not used; should be 0
4	16	Servo mode: 0 = open-loop mode, 1 = closed-loop mode
5	32	Profile mode: 0 = trapezoidal profile, 1 = velocity profile (acc ignored)
6	64	Direction: 0 = FWD, 1 = REV
7	128	Start motion now

The byte values are defined as constants in SERVO.H under LOAD_TRAJ.

Definition Loads motion trajectory information for a closed-loop driver.

Note: If the START_NOW bit is set, the motion will begin immediately; if it is not set, the motion will be started when ServoStartMotion () is called with the module's address.

Name	Type	Description
result	bool	True (1) on success; false (0) on failure

Example Closed-loop mode move to encoder location 1000, device 1, using existing vel and acc parameters, immediate execution:

```
result=ServoLoadTraj (0x01, 0xB1, 1000, 0, 0, 0)
```

Open-loop mode move of 200 motor pulses CCW, executed on ServoStartMotion():

```
result=ServoLoadTraj (0x01, 0x41, -200, 0, 0, 0)
```

Closed-loop mode velocity profiled move, velocity, and acceleration selected, immediate execution:

```
result=ServoLoadTraj (0x01, 0xA6, 0, 1023, 100, 0)
```

Reset Encoder

Syntax `result = ServoResetPos (addr)`

Argument/
Parameters

Name	Type	Description
addr	u8	Address of module

Description Resets the 32-bit encoder counter to 0. Also resets the internal command position to 0 to prevent the motor from jumping abruptly if the position driver is enabled. Do not issue this command while executing a motion.

Name	Type	Description
result	bool	True (1) on success; false (0) on failure

Set Gain Values

Syntax `result = ServoSetGain(addr, kp, kd, ki, il, ol, cl, el, sr, dc)`

Arguments/
Parameters

Name	Type	Description
addr	u8	Address of module
kp	i16	Position error gain
kd	i16	Not used (returns 0)
ki	i16	Integrator error gain
il	i16	Limit on integrator value
ol	u8	Not used (returns 255)
cl	u8	Not used (returns 0)
el	i16	Position error limit
sr	u8	Servo rate multiplier (1 is fastest)
dc	u8	Not used (returns 0)

Definition Sets the servo gains for a closed-loop driver.

Response

Name	Type	Description
result	bool	True (1) on success; false (0) on failure

Set Homing Conditions

Syntax `result = ServoSetHoming(addr, mode)`

Argument/
Parameters

Name	Type	Description
addr	u8	Address of module
mode	u8	The homing control byte. Should be set to the bitwise OR of the homing control bits defined in SERVO.H.

The mode byte's individual bits are defined as follows:

Bit	Weight	Description
0	1	Capture home position on change of Limit 1 (Reverse)
1	2	Capture home position on change of Limit 2 (Forward)
2	4	Turn motor off on home
3	8	Capture home on change of Index
4	16	Stop abruptly on home
5	32	Stop smoothly on home
6	64	Capture home position when an excess position error occurs
7	128	Capture home position when current limiting occurs

Description

Starts the homing for closed-loop driver. This command sets the homing conditions but does not start any motion. After setting the Homing mode to define which home signal to seek, the most straightforward way to find home is to load a velocity-mode move (see `ServoLoadTraj()`), in the direction towards the desired limit, with `START_NOW` bit set. The `HOME_IN_PROG` bit of the status byte should be monitored to detect when the home position has been captured.

Response

Name	Type	Description
result	bool	True (1) on success; false (0) on failure

Example

```
mode = 0x12  
(Go to forward limit and stop. Set forward limit as home.)
```

Stop Motor

Syntax `result = ServoStopMotor(addr, mode)`

Argument/
Parameters

Name	Type	Description
addr	u8	Address of module
mode	u8	The stop control byte. Should be set to the bitwise OR of the stop control bits defined in SERVO.H.

The mode byte's individual bits are defined as follows:

Bit	Weight	Description
0	1	Amp enable: 1 = raise amp enable output, 0 = lower amp enable
1	2	Motor off: set to turn motor off
2	4	Stop abruptly: set to stop motor immediately
3	8	Stop smoothly: set to decelerate motor smoothly

Description Stops a motor in the manner specified by mode.

Response

Name	Type	Description
result	bool	True (1) on success; false (0) on failure

I/O Module and Joystick Commands

Set Line to Input

Syntax `result = IoBitDirIn(addr, bitnum)`

Argument/
Parameters

Name	Type	Description
addr	u8	Address of module
bitnum	i16	The I/O line to be used as an input

Description Sets the specified I/O line (bitnum) to be used as an input.

Response

Name	Type	Description
result	bool	True (1) on success; false (0) on failure

Set Line to Output

Syntax `result = IoBitDirOut(addr, bitnum)`

Argument/
Parameters

Name	Type	Description
addr	u8	Address of module
bitnum	i16	The I/O line to be used as an output

Description Sets the specified I/O line (bitnum) to be used as an output.

Response

Name	Type	Description
result	bool	True (1) on success; false (0) on failure

Turn Off Output

Syntax `result = IoClrOutBit(addr, bitnum)`

Argument/
Parameters

Name	Type	Description
addr	u8	Address of module
bitnum	i16	The output bit to be cleared. Valid values are 0 to 7 for joystick, 0 to 6 for I/O modules.

Description

For the joystick, clears the value of output bit `bitnum` to 0 (turns off a joystick LED).

For the I/O modules, clears the value of an I/O node output bit `bitnum` to 0.

Response

Name	Type	Description
result	bool	True (1) on success; false (0) on failure

Query A/D Value

Syntax `ADCVal = IoGetADCVal(addr, channel)`

Argument/
Parameters

Name	Type	Description
addr	u8	Address of module
channel	i16	The motor channel to be defined

Definition

For the joystick, returns the A/D value (joystick axes coordinates) from channel 0 or 1. *Note: This data is only valid if bit 1 or 2 of the define status items byte (page 192) has been set in the last `LdcnDefineStatus()` or `LdcnReadStatus()` function call.*

For the I/O modules, returns the A/D value from channel 0, 1 or 2 from an I/O node. *Note: This data is only valid if the `SEND_ADn` ($n = 1, 2$ or 3) bit has been set in the most recently issued `LdcnDefineStat()` function.*

Response

Name	Type	Description
ADCVal	u8	The joystick axes positions of the defined motor channel

Query I/O Line

Syntax `result = IoGetBitDir(addr, bitnum)`

Argument/
Parameters

Name	Type	Description
addr	u8	Address of module
bitnum	i16	The I/O line to be defined

Description

Returns whether the specified I/O line (`bitnum`) is an input.

Response

Name	Type	Description
result	bool	True (1) if specified I/O line is an input; false (0) if it is not an input

Query Output Value

Syntax `outbyte = IoGetOutputs(addr)`

Argument/
Parameters

Name	Type	Description
addr	u8	Address of module

Description

For the joystick, returns the most recently set state of an output byte (joystick LEDs).

For the I/O modules, returns the most recently set state of an output byte of an I/O node.

Response

Name	Type	Description
outbyte	u16	Most recently set state of output byte

Query PWM Value

Syntax `PWMVal = IoGetPWMVal(addr, channel)`

Argument/
Parameters

Name	Type	Description
addr	u8	Address of module
channel	i16	The motor channel to be defined

Definition

This command is valid for the I/O modules only.

Returns the most recently set PWM value for channel 0 or 1 of an I/O node.

Response

Name	Type	Description
PWMVal	u8	The PWM value of the defined channel

Query Timer Mode

Syntax `TmrMode = IoGetTimerMode(addr)`

Argument/
Parameters

Name	Type	Description
addr	u8	Address of module

Definition

This command is valid for the I/O modules only.

Returns the most recently set timer control byte for an I/O node.

Response

Name	Type	Description
TmrMode	u8	The timer control byte of defined module.

Query Synchronous Timer/Counter Value

Syntax `TimerVal = IoGetTimerSVal(addr)`

Argument/
Parameters

Name	Type	Description
addr	u8	Address of module

Description

This command is valid for the I/O modules only.

Returns the synchronously captured timer or counter value from an I/O node.

Note: This data is only valid if the SEND_SYNC_TMR bit of statusitems has been set in the most recently issued LdcnDefineStat() function.

Response

Name	Type	Description
TmrVal	u32	The value of the timer or counter

Query Timer/Counter Value

Syntax `TimerVal = IoGetTimerVal(addr)`

Argument/
Parameters

Name	Type	Description
addr	u8	Address of module

Description

This command is valid for the I/O modules only.

Returns the timer or counter value from an I/O node.

Note: this data is only valid if the SEND_TIMER bit of statusitems has been set in the most recently issued LdcnDefineStat () function.

Response

Name	Type	Description
TmrVal	u32	The value of the timer or counter

Query Synchronous Input Value

Syntax `result = IoInBitSVal(addr, bitnum)`

Argument/
Parameters

Name	Type	Description
addr	u8	Address of module
bitnum	i16	The input bit to be defined

Definition

This command is valid for the I/O modules only.

Returns the value of a synchronously captured input bit from an I/O node.

Note: This data is only valid if the SEND_SYNCH_IN bit of statusitems has been set in the most recently issued LdcnDefineStat () function.

Response

Name	Type	Description
result	bool	True (1) if output is on; false (0) if off

Query Input Value

Syntax `result = IoInBitVal(addr, bitnum)`

Argument/
Parameters

Name	Type	Description
addr	u8	Address of module
bitnum	i16	The input bit to be defined. Valid joystick values are 1 to 4.

Definition

For the joystick, returns the value of input bit `bitnum` (joystick buttons). *Note: This data is only valid if bit 0 of the define status items byte (page 192) has been set in the last `LdcnDefineStatus()` or `LdcnReadStatus()` function call.*

For the I/O modules, returns the value of input bit `bitnum` from an I/O node. *Note: this data is only valid if the `SEND_INPUTS` bit of status items has been set in the most recently issued `LdcnDefineStat()` function.*

Response

Name	Type	Description
result	bool	True (1) if input is on; false (0) if off

Query Output Value

Syntax `result = IoOutBitVal(addr, bitnum)`

Argument/
Parameters

Name	Type	Description
addr	u8	Address of module
bitnum	i16	The output bit to be defined

Definition

This command is valid for the I/O modules only.

Returns the most recently set state of an output bit `bitnum` of an I/O node.

Response

Name	Type	Description
result	bool	True (1) if output is on; false (0) if off

Turn On Output

Syntax `result = IoSetOutBit(addr, bitnum)`

Argument/
Parameters

Name	Type	Description
addr	u8	Address of module
bitnum	i16	The output bit to be defined. Valid joystick values are 1 to 7.

Description Sets the value of an I/O node output bit `bitnum` to 1. On the joystick, this will turn on a LED.

Response

Name	Type	Description
result	bool	True (1) on success; false (0) on failure

Set Output Values

Syntax `result = IoSetOutputs(addr, outval)`

Argument/
Parameters

Name	Type	Description
addr	u8	Address of module
outval	u16	The values for the joystick LEDs or the output bits of the I/O modules

Description On the joystick, sets the values for the LEDs.
On the I/O modules, sets the values for the output bits.

Response

Name	Type	Description
result	bool	True (1) on success; false (0) on failure

Set PWM Value

Syntax `result = IoSetPMWVal(addr, pwm1, pwm2)`

Argument/
Parameters

Name	Type	Description
addr	u8	Address of module
pwm1	u8	PWM value for channel 1 of I/O node; should be between 0 and 255
pwm2	u8	PWM value for channel 2 of I/O node; should be between 0 and 255

Description

This command is valid for the I/O modules only.

Sets the PWM values for the two channels of an I/O node.

Response

Name	Type	Description
result	bool	True (1) on success; false (0) on failure

Set Future Output and PWM Values

Syntax `result = IoSetSynchOutput (addr, outbits, pwm1, pwm2)`

Argument/
Parameters

Name	Type	Description
addr	u8	Address of module
outbits	i16	Output bit values to be used
pwm1	u8	PWM value for channel 1 of I/O node; should be between 0 and 255
pwm2	u8	PWM value for channel 2 of I/O node; should be between 0 and 255

Description

This command is valid for the I/O modules only.
Specify the output bit values and the PWM values to be output at a later time when `LdcnSynchOutput ()` is called.

Response

Name	Type	Description
result	bool	True (1) on success; false (0) on failure

Set Timer/Counter Mode

Syntax `result = IoSetTimerMode (addr, tmrmode)`

Argument/
Parameters

Name	Type	Description
addr	u8	Address of module
tmrmode	u8	The timer control byte; should be set to the bitwise OR of the timer control bits defined in IO.H

Description

This command is valid for the I/O modules only.
Sets the counter/timer mode for an I/O node.

Response

Name	Type	Description
result	bool	True (1) on success; false (0) on failure

Synchronous Output

Syntax `result = IOSynchOutput (groupaddr)`

Argument/
Parameters

Name	Type	Description
groupaddr	u8	Group of modules to output

Definition

This command is valid for the I/O modules only.

Synchronous output command (0x05) issued to groupaddr. that causes a group of modules to synchronously output their previously buffered output commands. This will cause an I/O module to output previously stored output bit and PWM values.

Response

Name	Type	Description
result	bool	True (1) if output is on; false (0) if off

Synchronous Input

Syntax `result = LDCNSynchInput (groupaddr)`

Argument/
Parameters

Name	Type	Description
groupaddr	u8	Group of modules to be defined

Definition

This command is valid for the I/O modules only.

Synchronous input (Synch Input - 0x0C) command issued to groupaddr that causes a group of modules to synchronously capture input values. This will cause a SERVO or STEPPER module to store its current position as the home position and it will cause an I/O node to store its input bits and timer values.

Response

Name	Type	Description
result	bool	True (1) if output is on; false (0) if off

Example

The following C++ code section example lists the sequence of function calls to do the following:

1. Drive a Standard Picomotor connected to channel A of the first Picomotor driver in the network, 2000 steps clockwise (forward) in position mode at a speed of 2000 Hz with an acceleration of 255.
2. Drive a Tiny Picomotor connected to channel B of the same driver counterclockwise (backward) at a speed of 1000 Hz in velocity mode with an acceleration of 225 until relative number of steps moved is approximately -3000.

The current position is continuously displayed in real-time.

```
1 //Start of program
2
3 #include "stdafx.h"
4 #include "ldcncom.h"
5 #include "stepper.h"
6 #include "servo.h"
7
8 #define STEPMODTYPE 3
9 #define LOAD_TRAJ 0x04 //Load trajectory data
10 #define STOP_MOTOR 0x07 //Stop motor
11 #define SEND_ID 0x20
12 #define SPEED_8X 0x00 //use 8x timing
13 #define IGNORE_LIMITS 0x04 //Do not stop automatically
14 //on limit switches
15 #define POWER_ON 0x08 //set when motor power is on
16 #define STOP_SMOOTH 0x08 //set to decelerate
17 //motor smoothly
18 #define STP_ENABLE_AMP 0x01 //raise amp enable output
19 #define STP_DISABLE_AMP 0x00 //lower amp enable output
20 #define STP_AMP_ENABLED 0x04 //set if amplifier is
```

```

21                                     //enabled
22 #define START_NOW           0x80
23 #define LOAD_SPEED          0x02
24 #define LOAD_ACC             0x04
25 #define LOAD_POS            0x01
26 #define SEND_POS            0x01
27 #define STEP_REV             0x10 //reverse dir
28 #define TYPE_TINY           0x10
29 #define TYPE_STD             0x00
30 #define SET_CH_A             0x00
31 #define SET_CH_B             0x01
32
33 int main(int argc, char* argv[]) {
34     int num_modules;
35     int addr;
36     byte mod_type, mod_version;
37     byte pico_addr, outval;
38     byte mode, min_speed, run_current, hld_current, ADLimit,
em_acc, speed, acc;
39     long pos;
40
41     num_modules = LdcnInit("COM1", 19200);
42
43     // if the network is set to != 19200 baudrate
44     // the devices will not "hear" HardReset command
45     // LdcnFullInit() sends HardReset command at all
46     // possible baudrates
47
48     if (!num_modules)
49         num_modules = LdcnFullInit("COM1", 19200);
50
51     if (!num_modules) {
52         printf("No Modules found at COM1\n");
53         return 1;
54     }

```

```

55
56     // look for pico motor drivers
57     pico_addr = 0;
58     for (addr = 1; addr <= num_modules; addr++) {
59         LdcnReadStatus(addr, SEND_ID);
60         mod_type = LdcnGetModType(addr);
61         mod_version = LdcnGetModVer(addr);
62
63         if ((mod_type == STEPMODTYPE) && (mod_version >= 50)
&& (mod_version < 60))
64             { pico_addr = addr; break; }
65         }
66
67     if (pico_addr) {
68 // set parameters -----
69
70         min_speed = 1;
71         run_current = 0;
72         hld_current = 0;
73         ADLimit = 0;
74         em_acc = 255;
75         mode = SPEED_8X;      // or mode = SPEED_2X or
76                             // mode = SPEED_4X
77         mode |= IGNORE_LIMITS;
78         if (!StepSetParam(pico_addr, mode, min_speed,
run_current, hld_current, ADLimit, em_acc))
79             { printf("Communication Error"); LdcnShutdown(); return 1; }
80
81 // Select Motor Type and Channel -----
82     outval = TYPE_STD | SET_CH_A;
83
84 // Send output value to the device
85     StepSetOutputs(pico_addr, outval);
86
87 // Read device status

```

```

88     LdcnNoOp(pico_addr);
89         if (LdcnGetStat(pico_addr) & POWER_ON == 0)
90             printf("Invalid channel");
91
92     // Enable Driver -----
93     StepStopMotor(pico_addr, STOP_SMOOTH | STP_ENABLE_AMP);
94
95     // Load Trajectory -----
96     -
97     // Position mode (Velocity mode: mode = START_NOW |
98     // LOAD_SPEED | LOAD_ACC;)
99     mode = START_NOW | LOAD_SPEED | LOAD_ACC | LOAD_POS;
100    pos = 25*2000;//2000 steps
101    speed = 250;//2000 Hz
102    acc = 255;//max. acc.
103 StepLoadTraj(pico_addr, mode, pos, speed, acc, 0);
104
105 // wait end of the motion
106     do {
107         LdcnReadStatus(pico_addr, SEND_POS);
108         // read device status and current position
109         pos = StepGetPos(pico_addr)/25;//read steps
110         printf("   Position: %d\n", pos);
111     } while (LdcnGetStat(pico_addr) & MOTOR_MOVING);
112
113 // Disable driver amp (STOP_ABRUPT can also be used
114 // instead of STOP_SMOOTH)
115 StepStopMotor(pico_addr, STOP_SMOOTH);
116
117 // Wait 2 secs.
118 Sleep(2000);
119
120 // Drive different motor-----
121 // Select new Motor Type and new
122 // Channel (Tiny Type, Channel B)

```

```

122 outval = TYPE_TINY | SET_CH_B;
123     StepSetOutputs(pico_addr, outval);
124     // send output value to the device
125
126 // Read device status
127     LdcnNoOp(pico_addr);
128     if (LdcnGetStat(pico_addr) & POWER_ON == 0)
129     printf("Invalid channel");
130
131 // Reset Position
132 StepResetPos(pico_addr);
133
134 // Enable Driver Amplifier
135     StepStopMotor(pico_addr, STOP_SMOOTH | STP_ENABLE_AMP);
136
137 //Reload speed, mode (switch to velocity mode,
138 //reverse direction, start with ServoStartMotion command)
139 speed = 125;//1000 Hz
140 acc = 225;//Lower acc.
141 mode = LOAD_SPEED | LOAD_ACC | STEP_REV;
142 StepLoadTraj(pico_addr, mode, pos, speed, acc, 0);
143 ServoStartMotion(pico_addr);//Start motion
144
145 // Wait for end of motion, Read device status
146 //and current position
147 do {
148     LdcnReadStatus(pico_addr, SEND_POS);
149     pos = StepGetPos(pico_addr)/25;
150     printf("Position: %d\n", pos);
151 } while (pos>=-3000);//Move approximately 3000 steps
152
153 //Stop Motor Abruptly
154     StepStopMotor(pico_addr, STOP_ABRUPT | STP_ENABLE_AMP);
155
156 // Disable driver amp

```



```
157     StepStopMotor(pico_addr, STOP_ABRUPT);  
158     }  
159  
160     LdcnShutdown();  
161  
162     return 0;  
163 }  
164
```


Computer Control: Global Definitions

Addressing

Dynamic Addressing

Rather than using the hard-wired or switch-selected address of each DCN node, the host dynamically sets the address of each node with the aid of the daisy-chained **Network In** and **Network Out** lines. This allows additional DCN nodes to be added to an RS-485 network with no hardware changes.

On power-up, **Network In** of the first DCN node is pulled low, its communication is enabled, and the default address is 0x00. When a command is issued to give this node a new unique address, it will lower its **Network Out** line. Connecting **Network Out** to the **Network In** of the next node on the network will enable its communication at the default address of 0x00. Repeating this procedure allows a variable number of controllers present to be given unique addresses.

Group Addresses

In addition to the individual address, each node has a secondary group address. Several DCN nodes may share a common group address. This address is useful for sending commands which must be performed simultaneously by a number of nodes (e.g., `LdcnChangeBaud()`, etc.).

When a driver or joystick receives a command sent to its group address, it will execute the command but not send back a status packet. This prevents data collisions on the shared response line. When programming group addresses, however, the host can specify that one

member of the group is the “group leader.” The group leader will send back a status packet just like it would for a command sent to its individual address.

The group address is programmed using the `LdcnSetGroupAddr()` command.

Intelligent Picomotor Driver

Driver Identification

After power-up or `LdcnHardReset()` command and before first `StepStopMotor()` command with bit 0 set, input bits IN0 to IN5 from the input byte are used to identify the device type.

For Model 8751-C, the identification number is 0x00. For the Model 8753, the identification number is 0x01. The identification sequence should occur after initializing the network and reading the device type and version:

1. Read the states of input bits IN0 to IN5.
2. Set OUT4 to 1.
3. Read the states of input bits IN0 to IN5.

If the input states are inverted (see table below), the device’s identification number is the value in Step 1.

OUT4	IN5	IN4	IN3	IN2	IN1	IN0
0	0	0	0	0	0	1
1	1	1	1	1	1	0

Note:

The identification number is valid until first set to clear transition of OUT 4 or before the first Stop Motor command with bit 0 set.

An example of an identification sequence is as follows:

```
// C++ code segment to verify that a module at address pico_addr  
is a Picomotor Driver.
```

```
LdcnReadStatus(pico_addr, SEND_INBYTE);
```

```

id1=StepGetInByte(pico_addr);
StepSetOutputs(pico_addr, 0x10);
LdcnReadStatus(pico_addr, SEND_INBYTE);
id2=StepGetInByte(pico_addr);
StepSetOutputs(pico_addr, 0);
id1 &= 0x3F; //six bits ID
id2 |= 0xC0;
if ((id1==~id2) && (id1==1)) {
//This is a Picomotor drive
}

```

Driver Motor Selector

The Model 8753 has five internal control signals, OUT0 to OUT4, used to control the motor connector and type selector. OUT0 and OUT1 select the motor connector. OUT2 and OUT3 are reserved and should be cleared. OUT4 selects between the driver signal for the Standard Picomotor or Tiny Picomotor. The current motor type and connector selection can be changed after sending `StepStopMotor()` command with bit 0 in the stop control byte cleared. If the selected motor connector is not supported, bit 3 in the status byte will be cleared. The sequence to select another channel and/or change the motor type is as follows:

1. `StepStopMotor()` command with bit 0 cleared (stop motion and disable motor driver).
2. `StepSetOutputs()` command with desired motor connector (see table below).

OUT4	OUT3	OUT2	OUT1	OUT0	Status byte bit 3	Motor Selected
0	0	0	0	0	1	MOTOR A Standard
0	0	0	0	1	1	MOTOR B Standard
0	0	0	1	0	1	MOTOR C Standard
1	0	0	0	0	1	MOTOR A Tiny
1	0	0	0	1	1	MOTOR B Tiny

OUT4	OUT3	OUT2	OUT1	OUT0	Status byte bit 3	Motor Selected
1	0	0	1	0	1	MOTOR C Tiny
X	X	X	1	1	0	N/A
X	X	1	X	X	0	N/A
X	1	X	X	X	0	N/A

3. `StepStopMotor()` command with bit 0 of the stop control byte set will enable the selected motor if bit 3 = 1.



A Picomotor can be damaged if it is driven with the wrong type of driver signal for an extended period of time, so it is important to ensure that the motor driver is configured to generate the correct driver signals.

Model 8753 Open-Loop Driver Diagnostic

The Model 8753 is protected against motor output short and overtemperature. In addition, a missing motor can be detected while moving in negative direction. Two commands are required to gather complete diagnostic information. Status byte bit 2 (Motor On) and IN0 (STOP), IN1, and IN2 from the input byte are used for diagnostic. Motor On comes from `LdcnGetStat()`. INx come from `StepGetInByte()`.

Motor On	IN2	IN1	IN0 (STOP)	Diagnostic
X	0	0	0	OK
0	0	0	1	NO MOTOR (single step negative direction only with OUT4= 0)
0	1	0	1	MOTOR SHORT
X	X	1	0	OVER TEMPERATURE
0	X	1	1	OVER TEMPERATURE latched

Model 8753 Driver Velocity Profile Mode

Velocity profile mode is used to smoothly accelerate from one velocity to another. Commanded velocities are specified as integer values between 1 and 250. Minimum and maximum velocities for the different speed modes appear in the table below:

Speed factor	Step Rate Multiplier (K) (Minimum Velocity) in steps/sec.	Max. Step Rate in steps/sec. (Velocity = 250)
1x	1	250
2x	2	500
4x	4	1,000
8x	8	2,000

Step Rate Multipliers and Maximum Velocities for Different Speed Factors

The actual velocity V in steps per second can be obtained using the formula $V = S * K$, where

S is commanded velocity (range 1 to 250) and

K is the step rate multiplier for current speed factor (see the table)

The acceleration or deceleration is achieved by incrementing (or decrementing) the current integer velocity value by one until the goal velocity is reached. The actual time for acceleration from one velocity to another can be obtained using the formula:

$T_{acc} = |(64 - 0.25 * Acc) * (S1 - S0)|$ in ms, where

Acc is the acceleration value (range 1–255),

$S0$ is current velocity (range 1–250),

$S1$ is target velocity (range 1–250), and

T_{acc} is the time to accelerate from velocity $S0$ to $S1$ with acceleration Acc

Examples

1. Accelerating to velocity 125 with minimum profile velocity = 25 and acceleration = 100.

$$\text{Acc} = 100, \text{S0} = 25, \text{S1} = 125.$$

$$|(64 - 0.25 * 100) * (125 - 25)| = |39 * 100| = |3900| = 3900 \text{ ms (3.9 s)}$$

2. Decelerating from velocity 125 to stop with minimum profile velocity = 25 and acceleration 100.

$$\text{Acc} = 100, \text{S0} = 125, \text{S1} = 25.$$

$$|(64 - 0.25 * 100) * (25 - 125)| = |39 * (-100)| = |-3900| = 3900 \text{ ms (3.9 s)}$$

Note:

To change the direction of motion, a stop command must first be issued before a velocity in the opposite direction is commanded.

Model 8753 Driver Power-Up and Reset Conditions

On power-up or reset, the following state is established:

- Motor position is reset to zero.
- Velocity and acceleration values are set to zero.
- All parameters are set to zero.
- All outputs are cleared.
- The motor driver is disabled.
- The default status data is the status byte only.
- The individual address is set to 0x00.
- The group address is set to 0xFF (group leader is not set).
- Communications are enabled or disabled depending on “A in.”
- “A out” is HIGH, disabling the next drive communications.
- The baud rate is set to 19.2 Kbps.

Model 8753 Driver: Define Status Items Byte

Default = 0x00

Bit	Description	Bytes Sent
0	Send position	4 bytes
1	Reserved;set to 0	N/A

Bit	Description	Bytes Sent
2	Reserved;set to 0	N/A
3	Send input byte	byte
4	Reserved;set to 0	N/A
5	Send device ID and version number	2 bytes (driver device ID = 3, version number = 50–59)
6	Send I/O state	byte
7	Reserved;set to 0	N/A

Model 8753 Driver: Status Byte

Bit	Name	Definition
0	Motor is moving	This bit is set when the motor is moving and cleared otherwise.
1	Checksum error	Set if there was a checksum error in the command packet received
2	Motor is on.	Set if the motor power driver is enabled
3	Motor selector status	Cleared if selected motor connector is out of range
4	At commanded velocity	Set if the commanded velocity is reached
5	Velocity profile mode	Set if the motor is moving in velocity mode
6	Position (trapezoidal) profile mode	Set if the motor is moving in trapezoidal mode
7	Reserved	

Model 8753 Driver: Input Byte

Bit	Name	Definition
0	IN0	The value of bit IN0 (STOP)
1	IN1	The value of bit IN1
2	IN2	The value of bit IN2
3	IN3	The value of bit IN3
4	IN4	The value of bit IN4
5	IN5	The value of bit IN5
6	Reserved	
7	Reserved	

Model 8753 Driver: I/O State Byte

Bit	Name	Definition
0	IN0	The value of bit IN0 (STOP)
1	IN1	The value of bit IN1
2	IN2	The value of bit IN2
3	OUT0	The value of Motor selector bit 0
4	OUT1	The value of Motor selector bit 1
5	OUT2	The value of Motor selector bit 2
6	OUT3	The value of output bit 3 (Reserved)
7	OUT4	The value of Motor selector bit 4 (0 = Standard, 1 = Tiny)

Note: IN0, IN1 and IN2 in input byte and I/O state byte are the same inputs.

Closed-Loop Picomotor Driver

Model 8751-C Closed-Loop Driver Diagnostic

The Model 8751-C is protected against and can detect and report status on overtemperature, missing motors, shorted motors, stuck motors, encoder errors. In addition, it has a STOP input which will disable motion when open-circulated.

The diagnostic information is different depending on whether or not the Servo is enabled (defined by ENABLE_SERVO bit of mode sent to ServoLoadTraj () , and possibly reset by ServoStopMotor ()).

Status Bits and LED

Bit 3 (Power_on), bit 5 (Reverse Limit) and bit 6 (Forward Limit) of Status Byte and bit 0 (Index) of Auxiliary Status byte are used for reading input signals and drive diagnostics as shown in the tables below. Using DLL control, the status can be read by LdcnGetStat() and auxiliary status by ServoGetAux(). The driver's LED also can be used for diagnosis.

Servo Mode Of

In the SERVO OFF condition, the Forward Limit and Reverse Limit bits are used to indicate over-temperature and external STOP conditions as shown below. Bit 4, position error, may be in either state with the SERVO OFF, depending on the last result before the driver was disabled.

Status byte				Condition	Driver LED
Bit 6 (Forward Limit)	Bit 5 (Reverse Limit)	Bit 4 (Position Error)	Bit 3 (Power_on)		
1	0	X	1	STP IN ACTIVATED	Low intensity
0	1	X	1	OVERHEAT	Low intensity

Status byte				Condition	Driver LED
Bit 6 (Forward Limit)	Bit 5 (Reverse Limit)	Bit 4 (Position Error)	Bit 3 (Power_on)		
0	0	X	1	STP IN ACTIVATED OVERHEAT	Low intensity
1	1	X	1	OK CONDITION	Low intensity

Thus, the status codes 0x59 and 0x49 correspond to external STOP activated. 0x39 and 0x29 correspond to driver overheated. 0x19 and 0x09 correspond to both external stop and driver overheated. The normal condition for Servo Off is 0x79 or 0x69, which mean that the driver will operate on receipt of a move command.

Servo Mode ON and Power Driver ON condition

Diagnostic bits. In the SERVO ON condition, the Forward Limit and Reverse Limit bits show the condition of the limit sensors.

Status byte			Limit Sensor Input State	Driver LED
Bit 6 (Forward Limit)	Bit 5 (Reverse Limit)	Bit 3 (Power_on)		
0	1	1	Forward Limit=Active (Forward limit reached)	High intensity
1	0	1	Reverse Limit =Active (Reverse limit reached)	High intensity
0	0	1	Forward Limit =Active Reverse Limit =Active (Error condition, both limits sensed)	High intensity
1	1	1	(In Safe Zone)	High intensity

Servo Mode ON and Driver Fault (Power will not enable)

Diagnostic status bits 5 and 6 are used to display driver fault error codes.

Status byte				Condition	LED
Index (Aux Bit 0)	Bit 6 (Forward Limit)	Bit 5 (Reverse Limit)	Bit 3 (Power_on)		
1	1	0	0	STP IN (LATCHED)	Low intensity
0	1	0	0	ENCODER ERROR	Low intensity
X	0	1	0	MOTOR SHORT	Low intensity
X	0	0	0	NO MOTOR	Low intensity
X	1	1	0	OVERHEAT	Low intensity

Thus, 0x51 corresponds to External STOP or Encoder Fault (differential signal not detected). The Auxiliary status byte, bit 0 identifies which; 0x31 corresponds to a motor short circuit, 0x11 corresponds to missing motor, and 0x71 corresponds to driver over temperature.

Model 8751-C Driver Power-Up and Reset Conditions

On power-up or reset, the following state is established:

- Motor position is reset to zero.
- Velocity and acceleration values are set to zero.
- All parameters are set to zero.
- All outputs are cleared.
- The motor driver is disabled.
- The default status data is the status byte only.
- The individual address is set to 0x00.
- The group address is set to 0xFF (group leader is not set).
- Communications are enabled or disabled depending on “A in.”
- “A out” is HIGH, disabling the next drive communications.
- The baud rate is set to 19.2 Kbps.

Model 8751-C Driver: Status Byte

Bit	Name	Definition
0	Move_done	Clear when in the middle of a trapezoidal profile move or in velocity mode, when accelerating from one velocity to the next. This bit is set otherwise, including while the position servo is disabled.
1	Cksum_error	Set if there was a checksum error in the just received command packet
2	No_motor	Set if missing motor is detected. Must be cleared by user with Clear Sticky Bits command (or by toggling SER/NOS in MCL).
3	Power_on/diag.bit	Refer to "Model 8751-C Closed-Loop Driver Diagnostic" section beginning on page 187.
4	Pos_error	Set if the position error has exceeded the position error limit. It is also set whenever the position servo is disabled. Must be cleared by user with Clear Sticky Bits command (or by toggling SER/NOS in MCL).
5	Limit 1 (Reverse) /	Reverse Limit or diagnostic bit (refer to "Model 8751-C Closed-Loop Driver Diagnostic" section beginning on page 187).
6	Limit 2 (Forward) /	Forward Limit or diagnostic bit (refer to "Model 8751-C Closed-Loop Driver Diagnostic" section beginning on page 187).
7	Home_in_progress	Set while searching for a home position. Reset to 0 once the home position has been captured.

Model 8751-C Driver: Auxiliary Status Byte

Bit	Name	Definition
0	Index/diag.bit	Complement of the value of the index input or diagnostic bit (refer to “Model 8751-C Closed-Loop Driver Diagnostic” section beginning on page 187).
1	Pos_wrap	Set if the 32-bit position counter wraps around. Must be cleared with the Clear Sticky Bits command (or by toggling SER/NOS in MCL).
2	Servo_on	Set if the position servo is enabled; clear otherwise.
3	Accel_done	Set when the initial acceleration phase of a trapezoidal profile move is completed. Cleared when the next move is started.
4	Slew_done	Set when the slew portion of a trapezoidal profile move is complete. Cleared when the next move is started.
5	Servo_overrun	At the highest baud rate and servo rate, certain combinations of calculations may cause the servo, profiling, and command processing to take longer than 0.512 msec, in which case, this bit will be set. This is typically not serious, only periodically introducing a small fraction of a millisecond delay to the servo tick time. Cleared with the Clear Sticky Bits command (or by toggling SER/NOS in MCL).

Joystick

Joystick: Define Status Items Byte

Default = 0x00

Bit	Description	Bytes Sent
0	Send I/O Byte 0 and Byte 1	2 bytes (button 0 is bit 0 in I/O byte 1, button 1 is bit 1 in I/O byte 1,...)
1	Send ANALOG IN 0 value— Joystick X axis	1 byte
2	Send ANALOG IN 1 value— Joystick Y axis	1 byte
3	Reserved	N/A
4	Send timer value	4 bytes, least significant first
5	Send device ID, version number	2 bytes (8754 device ID = 2, version number = 1)
6	Send I/O bit values captured with the Synch Input command	2 bytes
7	Send timer value captured with the Synch Input command.	4 bytes

Joystick: Status Byte

Bit	Description
0	Undefined
1	Checksum error detected (if set)
2	Undefined
3	Undefined
4	Undefined
5	Undefined
6	Undefined
7	Undefined

Troubleshooting

Closed-Loop Picomotor Driver

Motor Does Not Move

When the motor attached to a closed-loop Picomotor does not move, it could indicate any of the following:

- **The Picomotor is at the end of its travel range.** Servo-controlled moves are disabled when the limit sensors on the closed-loop picomotor are triggered. Reposition motor to within its travel range.
- **A motor is not connected to the selected driver.** Check the connections or switch to the correct driver.
- **The driver amplifier has been disabled.** In MCL, use `MON <driver>` to enable the amplifier.
- **The motor or driver may have encountered a fault condition.** Check for fault conditions using the `STA` command (see Status Items section for definitions of fault conditions)

Motor Does Not Move Proper Number of Encoder Counts for Requested Motion

When the motor does not move the proper number of encoder counts, it could indicate any of the following:

- **The picomotor is at the end of its travel range.** Servo-controlled moves are disabled when the limit sensors on the closed-loop picomotor are triggered. Reposition the motor to within its travel range.

- **The driver is not in closed-loop mode.** In MCL, use `SER <driver>` to ensure closed-loop motion. Under DLL control, mode bit 4 determines if a motion is to be performed in closed-loop mode.
- **The motor is stuck or obstructed.** This should cause the Position Error status, as the servo loop is unable to reach target. You can use a wrench to turn the end of the motor drive screw to check for obstructions.

Driver LED is Dim

If the closed-loop driver's LED is dim, this indicates that the motor amplifier is disabled. Either a user command or error condition has caused the amplifier to disable. Enable the amplifier using `MON <driver>`. If the LED remains dim, check driver status with `STA` or `LdcnGetStat ()`.

Joystick

Moving the Joystick Does Not Move Any Picomotors

When moving the joystick does not move any Picomotors, it could indicate any of the following:

- **The Picomotor is at the end of its travel range.**
- **A motor is not connected to the selected axis.** Check the connections, or switch to another axis.
- **The cables are not connected or are loose.** Check the connections.
- **The joystick is disabled.** If all three driver LEDs are on, the joystick has been manually disabled. Press the **Set Axis/Enable** button and then the **X+Y/Enable** button on top of the joystick to enable it for use.
- **The joystick may be locked from another port** (all LEDs on the joystick will be lit if it is locked). An `UnLock` or `JON MCL` command must be issued from the controlling port in order for the joystick to switch from command mode to stand-alone mode.
- **Both joystick axes are disabled.** If two driver LEDs are on but no motor LEDs are lit, then no motors have been assigned. See “Selecting the Motors to Control” on page 41 for instructions.

Picomotor Moves Too Slow (or Too Fast)

The joystick speed has been changed. Push down the **Driver** and **X+Y Enable** buttons at the same time to toggle between slow and fast speeds.

All LEDs on Joystick are On

The network controller is set to command mode, and the joystick is disabled. Use the `Unlock` or `Jon` command from MCL to switch to stand-alone mode and enable the joystick.

No LEDs on Joystick are On

If no LEDs are lit on the joystick:

- **The joystick may not be connected to the network.** Check the cable connections.
- **The joystick may not have power.** Verify that the joystick dip switch settings are in the default position (page 232). If the dip switch settings are correct, refer to the “Setting Up” chapter beginning on page 23 to check that your set-up is correct.

Three Driver LEDs on Joystick are On

The joystick is disabled. Press the **Set Axis/Enable** button and then the **X+Y/Enable** button to enable the joystick.

Motor Light on Joystick Will Not Illuminate

The motor is already programmed for the other axis, or the motor is not selected. Press the **Motor** button until the desired motor is selected.

Driver LED on Joystick Cannot Be Selected

The Picomotor driver was not present during boot-up. Connect the driver and reboot. (This can be done either with a power-up or by pressing the **Set Axis/Enable**, **Driver**, and **Motor** buttons on the joystick.)

Set X and Set Y LEDs Flash on Joystick

No drivers are detected or present on the network. Check your connections and reboot.

Joystick Axes Settings Return to Default After Power-Up

The battery backup for the RAM is not enabled on the network controller. Verify that SW5 on the controller is on (the switch setting should be up).

Hand Terminal

Picomotor Does Not Respond to Keypad Commands

If the picomotor is not responding to keypad commands, it may indicate one of the following:

- **The hand terminal is locked out from another port.** To unlock, issue an `UnlOck` command from the controlling port, or press the **Motor** and **X+Y Enable** buttons on the joystick.
- **The joystick is not turned off.** “J” will appear in upper left corner of display. Press **Shift** and then **JOF** to turn off joystick.

Picomotor Moves Too Slow (or Too Fast)

The speed has been changed. Press **Shift** then **Hi/Lo** on the hand terminal to toggle between slow and fast speeds (fine and coarse). To set specific speed, you will need to issue a `VEL` command from one of the other ports.

Network Controller

Network Controller LED Flashes

The joystick is not connected to the network. Check the cable connections.

Speed Values Return to Default After Power-up

The changes to the speed values were not saved before shutdown. After using MCL commands to change speed values, issue a SAV command to retain the values.

MCL Commands Not Functioning Correctly

If the REL, FOR, and REV commands are not functioning as desired, try sending a JOF command first.

No Line Feeds When Using MCL in Hyperterminal

You may experience problems with line feeds in some versions of Hyperterminal. An alternate program, Network Controller Terminal, is available on the New Focus web site.

Ethernet Controller

Picomotor Does Not Respond to Commands

The Ethernet may not be hooked up to Ethernet controller. Check the LED: it will be flashing if connection is being made. If the LED is on but not flashing, an Ethernet connection has not been made.

Picomotor Does Not Move with MCL Commands

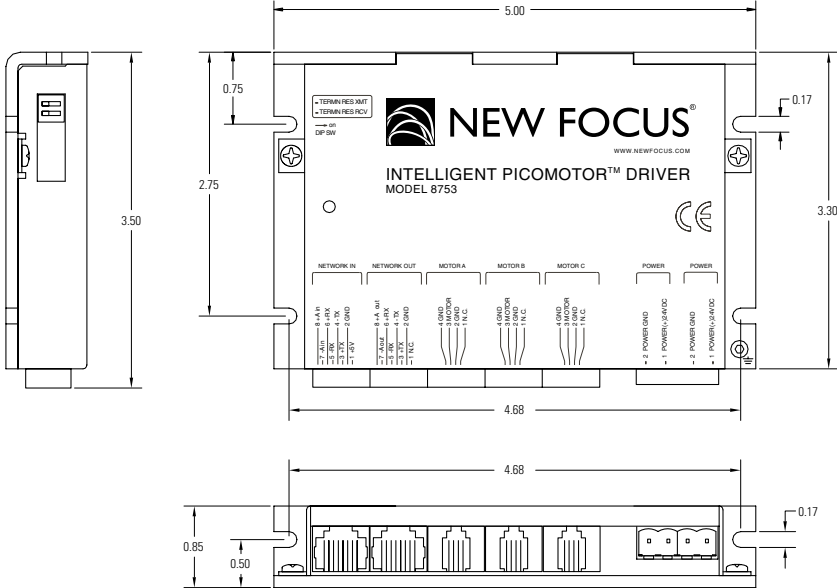
If the picomotor is not responding to keypad commands, it may indicate one of the following:

- **The joystick is not disabled.** Issue a JOF command to disable it.
- **There is a “lock” from one of the other ports.** To unlock, issue an UnLock command from the controlling port, or press the Motor and X+Y Enable buttons on the joystick.

Specifications

Model 8753 Intelligent Picomotor Drivers

Driver Mechanical Drawings



Note: All dimensions are in inches.

Driver Characteristics

Specification	Model 8753
Power Supply Voltage	21 to 29 VDC
Power Supply Current	Average 0.65 Amp DC (typical)

Specification	Model 8753
Output Frequency Range	1 Hz to 2KHz
Maximum Output Frequency (w/o forced cooling)	1.0 kHz @ 100% duty cycle 2 kHz @ 50% duty cycle (ON time max 120 sec)
Number of Channels	3
Number of Active Channels at Once	One
Communication Protocol	Distributed Control Network (DCN)
Maximum Number of Drivers (per network)	31
Communication Interface	RS-485
Serial Baud Rate	19.2 to 115.2 Kbps
LED (two intensity levels)	Power 'OK'—low intensity Ready—high intensity
Output Short Protection (motor output to ground)	Shutdown if motor output is shorted
Over Temperature Protection	Shutdown at 70° C
Fire Safety: Internal Fuse	3A Quick blow
Storage Temperature	-30 to +85° C
Operating Temperature	10 to 45° C
Power Supply Connectors	2 x 2-pin Phoenix MSTB 2.5/2-ST-5.08 (or equivalent)
Picomotor Connectors	4-pin RJ-22 (3x)
Communication Interface	8-pin RJ-45
Size (L x H x D)	5" x 0.85" x 3.3"
Weight	0.55 lb (250 g)
Certification	CE In conformity with the following standards: UL 60950:2000, EN 60950:2000, CSA E60065-00, 89/336/EEC

Note: Rated at 25 °C ambient, POWER (+) = 24VDC

Driver Pinouts

Driver DIP Switches

SW	Signal	Description
1	Term Res RCV	Receive line terminator (Default=off. The last driver in the network should have this on.)
2	Term Res XMT	Transmit line terminator (Default=off. The last driver in the network should have this on.)

Driver Power

Pin	Signal	Description
1	POWER (+) 24 VDC	+21 to +29 VDC power supply, positive terminal
2	POWER GND*	Power supply ground
1	POWER (+) 24 VDC	+21 to +29 VDC power supply, positive terminal
2	POWER GND*	Power supply ground

* POWER GND and GND are electrically connected. Driver's case is isolated from the circuitry and can be grounded externally.

Driver Motor A, Motor B, and Motor C Connectors

Pin	Signal	Description
1	N.C.	Not connected
2	GND*	Power ground
3	MOTOR	Motor output
4	GND*	Motor ground

* POWER GND and GND are electrically connected. Driver's case is isolated from the circuitry and can be grounded externally.

Driver Network Out

Pin	Signal	Description
1	N.C.	Not connected
2	GND*	Interface ground
3	+TX	(+) Transmit data
4	-TX	(-) Transmit data
5	-RX	(-) Receive data
6	+RX	(+) Receive data
7	-A out	(-) Address output
8	+A out	(+) Address output

* POWER GND and GND are electrically connected. Driver's case is isolated from the circuitry and can be grounded externally.

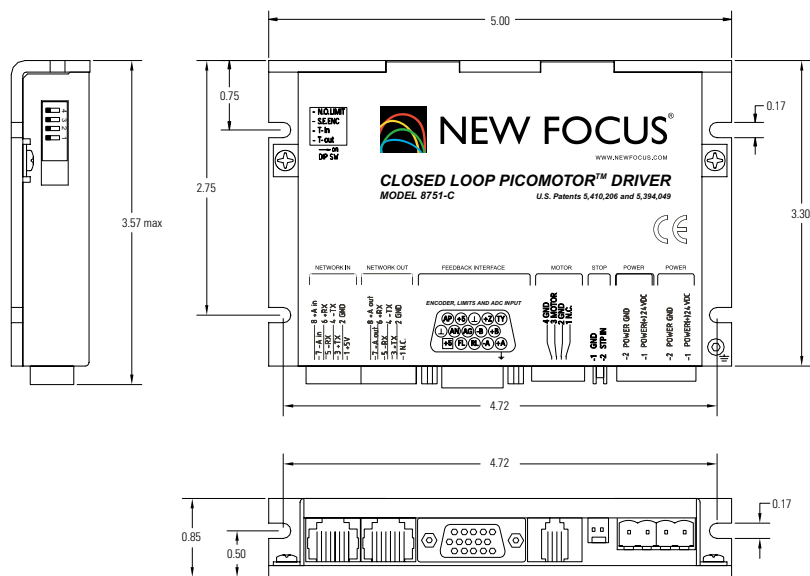
Driver Network In

Pin	Signal	Description
1	+5V	RS-232 adapter power supply (200 mA Max)
2	GND*	Interface ground
3	+TX	(+) Transmit data
4	-TX	(-) Transmit data
5	-RX	(-) Receive data
6	+RX	(+) Receive data
7	-A in	(-) Address input
8	+A in	(+) Address input

* POWER GND and GND are electrically connected. Driver's case is isolated from the circuitry and can be grounded externally.

Model 8751-C Closed-Loop Picomotor Drivers

Driver Mechanical Drawings



Driver Characteristics

Specification	Model 8751-C
Style	Intelligent Picomotor Driver for Closed-Loop Picomotor
Number of Motors	1
Max. Pulse Rate	Up to 2 kHz
Input Voltage	12-32 VDC
Interface	RS-485
Typical Power Consumption	17 Watts *
Size (without cables)	5.00 x 3.50 x 0.85 inches
CE Compliant	Yes

* At 2-kHz sustained speed

Driver Dip Switch

Pin	Signal	Description
1	T-in	Receive line terminator
2	T-out	Transmit line terminator
3	S.E. ENC	OFF = Differential encoder connected ON = Single ended encoder or no encoder connected
4	N.O. LIMIT	OFF = Normally closed limit switches ON = Normally open limit switches

Driver Pinouts

Driver Dip Switch

SW	Signal	Description
1	Term Res RCV	Receive line terminator (Default=off. The last driver in the network should have this on.)
2	Term Res XMT	Transmit line terminator (Default=off. The last driver in the network should have this on.)

Driver Power (CN1)

Pin	Signal	Description
1,3	POWER (+)21 to 29VDC	+21 to +29VDC power supply, positive terminals
2,4	POWER GND*	Power supply ground terminals

* POWER GND and GND are electrically connected. Driver's case is isolated from the driver's circuitry and may be grounded externally.

Driver Stop (CN2)

Pin	Signal	Description
1	GND*	Interface ground
2	STP IN	Stop input. Connect to GND to enable the motor

* POWER GND and GND are electrically connected. Driver's case is isolated from the driver's circuitry and may be grounded externally.

Driver Motor (CN3)

Pin	Signal	Description
1	N.C.	Not connected
2	GND*	Power ground
3	MOTOR	Motor output
4	GND*	Motor ground

* POWER GND and GND are electrically connected. Driver's case is isolated from the driver's circuitry and may be grounded externally.

Driver Feedback Interface (CN4)

Pin	Signal	Description
1	+5**	+5V Limit sensors power supply
2	+L	Forward limit input
3	-L	Reverse limit input
4	-A	Encoder phase -A
5	+A	Encoder phase +A
6	⊥*	Interface ground
7	AN	Analog input
8	AG	Analog input ground
9	-B	Encoder phase -B

Pin	Signal	Description
10	+B	Encoder phase +B
11	AP	Analog +5V
12	+5**	+5V Encoder power supply
13	⊥ *	Interface ground
14	+Z	Encoder index
15	TY	Piezo Motor type (Open = Standard, GND = Tiny)

* POWER GND and GND are electrically connected. Driver's case is isolated from the driver's circuitry and may be grounded externally.

** 0.25A Max for all outputs combined.

Driver Network Out (Slave) (CN5)

Pin	Signal	Description
1	N.C.	Not connected
2	GND*	Interface ground
3	+TX	(+) Transmit data
4	-TX	(-) Transmit data
5	-RX	(-) Receive data
6	+RX	(+) Receive data
7	-A out	(-) Address output
8	+A out	(+) Address output

* POWER GND and GND are electrically connected. Driver's case is isolated from the driver's circuitry and may be grounded externally.

Driver Network In (Host) (CN6)

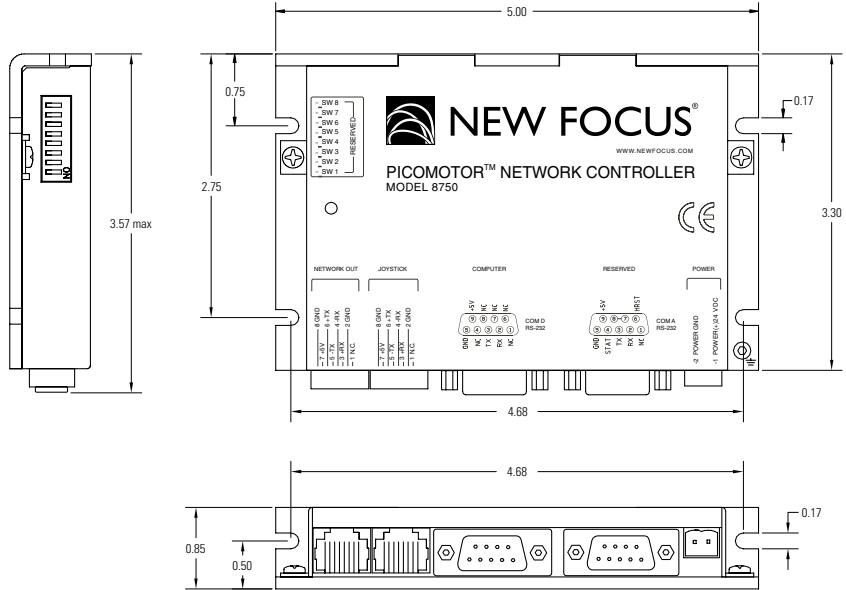
Pin	Signal	Description
1	+5V**	RS-232 adapter power supply
2	GND*	Interface ground
3	+TX	(+) Transmit data
4	-TX	(-) Transmit data
5	-RX	(-) Receive data
6	+RX	(+) Receive data
7	-A in	(-) Address input
8	+A in	(+) Address input

* POWER GND and GND are electrically connected. Driver's case is isolated from the driver's circuitry and may be grounded externally.

** 0.25A Max for all outputs combined.

Model 8750 Intelligent Picomotor Network Controller

Network Controller Mechanical Drawings



Note: All dimensions are in inches.

Network Controller Characteristics

Specification	Model 8750
Power Supply Voltage	12 to 32 VDC, (10 to 40 VDC Abs. Max range); Supply current <100 mA at 24 VDC
CPU	Rabbit 2000™—18.432 MHz
Flash Memory	256K
RAM	128K
RAM Backup Battery	3V—CR2032
COM A	RS-232, D-sub 9-pin connector (female)
Com D	RS-232 or RS-485 half duplex (2 wire), D-sub 9-pin connector (female)
Network Out	RS-485 full duplex (4 wire) DCN-compatible, 8-pin RJ-45 connector
Joystick	RS-485 full duplex (4 wire) DCN-compatible, 8-pin RJ-45 connector
Power Connector	Phoenix MSTB 2.5/2-ST-5.08 (or equivalent)
Storage Temperature	–30 to +85° C
Operating Temperature	0 to 45° C
Size	5.00" x 3.30" x 0.85"
Weight	0.55 lb (250 g)
Certification	CE In conformity with the following standards: EN 60950:2000, 89/336/EEC

Note: Rated at 25°C ambient, POWER(+) 24VDC

Network Controller Pinouts

Network Controller DIP Switches

SW	Function	Description	Factory Default
1	SWITCH A (/PD0)	Configuration switch connected to PD0 (ON = logic "0")	0
2	SWITCH B (/PD1)	Configuration switch connected to PD1 (ON = logic "0")	0
3	SWITCH C (/PD2)	Configuration switch connected to PD2 (ON = logic "0")	0
4	SWITCH D (/PD3)	Configuration switch connected to PD3 (ON = logic "0")	0
5	BATTERY ON/OFF	RAM backup battery ON/OFF	1
6	COM A COLD BOOT	ON = COM A COLD BOOT ENABLED	0
7	HOST RESET EN	ON = HOST RESET ENABLED	0
8	CPU RESET SW	ON = CPU RESET	0

Network Controller Power Connector

Pin	Signal	Description
1	POWER (+) 24V	12 to 32 V power supply, positive terminal
2	POWER GND*	Power supply ground

Network Controller COM A Connector

Pin	Signal	Description
1	N.C.	Not connected
2	RX	Receive data
3	TX	Transmit data
4	STAT	STATUS output from Rabbit 2000 CPU (used by software development tools)

Pin	Signal	Description
5	GND*	Interface ground
6	HRST	HOST RESET input (used by software development tools) Enabled by HOST RESET EN switch
7	Connected to pin 8	
8	Connected to pin 7	
9	+5V**	+5V Power output

* POWER GND and GND are electrically connected. Controller's case is isolated from the circuitry and can be grounded externally.

** 250-mA maximum for all outputs combined.

Network Controller COM D

Pin	Signal	Description
1	N.C.	Not connected
2	RX	Receive data
3	TX	Transmit data
4	N.C.	Not connected
5	GND*	Interface ground
6	N.C.	Not connected
7	N.C.	Not connected
8	N.C.	Not connected
9	+5V**	+5V Power output

* POWER GND and GND are electrically connected. Controller's case is isolated from the circuitry and can be grounded externally.

** 250 mA MAX for all outputs combined.

Network Controller Joystick Connector

Pin	Signal	Description
1	N.C.	Not Connected
2	GND*	Interface ground
3	+RX	(+) Receive data
4	-RX	(-) Receive data
5	-TX	(-) Transmit data
6	+TX	(+) Transmit data
7	+5V**	+5V Power output
8	GND*	Interface ground

* POWER GND and GND are electrically connected. Controller's case is isolated from the circuitry and can be grounded externally.

** 250 mA MAX for all outputs combined.

Network Controller Network Out Connector

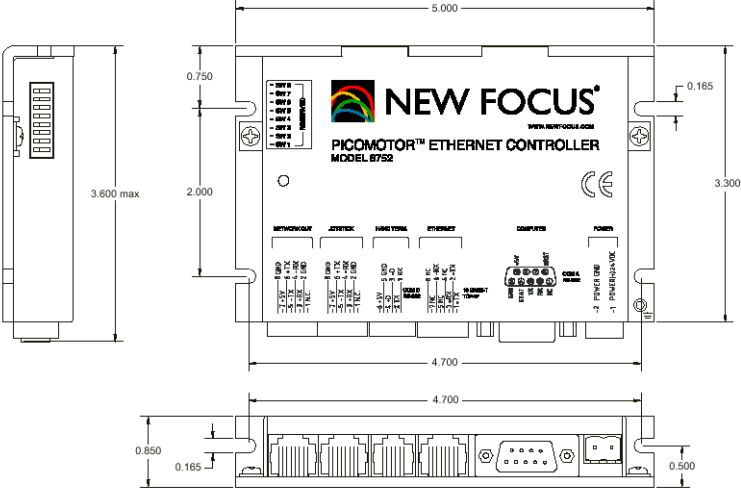
Pin	Signal	Description
1	N.C.	Not Connected
2	GND*	Interface ground
3	+RX	(+) Receive data
4	-RX	(-) Receive data
5	-TX	(-) Transmit data
6	+TX	(+) Transmit data
7	+5V**	+5-V Power output
8	GND*	Interface ground

* POWER GND and GND are electrically connected. Controller's case is isolated from the circuitry and can be grounded externally.

** 250 mA MAX for all outputs combined.

Model 8752 Intelligent Picomotor Ethernet Controller

Ethernet Controller Mechanical Drawing



Ethernet Controller Characteristics

Specification	Model 8752
Power Supply Voltage	12–32 VDC, (10–40VDC abs. max. range)
Power Supply Current	<100 mA at 24V DC
CPU	Rabbit 2000™—18.432 MHz
Flash Memory	256K
RAM	128K
RAM Backup Battery	3V—CR2032
Ethernet Interface	10Base-T; 8-pin RJ-45 connector
Computer (COM A)	RS-232, D-sub 9-pin connector (female)
Network Out	RS-485 full duplex (4 wire) DCN compatible; 8-pin RJ-45 connector
Joystick	RS-485 full duplex (4 wire) DCN compatible; 8-pin RJ-45 connector
Hand Terminal (COM D)	RS-232 or RS-485 half duplex (2 wire); 6-pin RJ-45 connector
Power Connector	Magnum EM2565-02-VL or Phoenix MSTB 2.5/2-ST-5.08
10Base-T Status LED	Low—no 10Base-T Link connection High—10Base-T Link connection ready Blinking—10Base-T activity
Storage Temperature Range	–30 to +85 °C
Operating Temperature Range	0 to 45 °C
Size	5.00" x 3.30" x 0.85"
Weight	0.55 lb. (.250 kg)

Note: Rated at 25° C ambient, POWER(+) 12–32V = 24VDC

Ethernet Controller Dip Switches

SW	Function	Description	Factory Default
1	SWITCH A (/PD0)	Configuration switch connected to PD0 (ON = logic "0")	0
2	SWITCH B (/PD1)	Configuration switch connected to PD1 (ON = logic "0")	0
3	SWITCH C (/PD2)	Configuration switch connected to PD2 (ON = logic "0")	0
4	SWITCH D (/PD3)	Configuration switch connected to PD3 (ON = logic "0")	0
5	BATTERY ON/OFF	RAM Backup battery ON/OFF	1
6	COM A COLD BOOT	ON = COM A cold boot enabled	0
7	HOST RESET EN	ON = Host reset enabled	0
8	CPU RESET SW	ON = CPU reset	0

Ethernet Controller Pinouts

Ethernet Controller Power Connector

Pin	Signal	Description
1	POWER (+) 12–32V	12–32V power supply, positive terminal
2	POWER GND*	Power supply ground

* POWER GND and GND are electrically connected. Controller's case is isolated from the controller circuitry and can be grounded externally.

Ethernet Controller Computer (COM A) Connector

Pin	Signal	Description
1	N.C.	Not connected
2	RX	Receive data
3	TX	Transmit data
4	STAT	STATUS output from Rabbit 2000 CPU (used by software development tools)
5	GND*	Interface ground
6	HRST	HOST RESET input (used by software development tools); enabled by HOST RESET EN switch
7	Connected to pin 8	
8	Connected to pin 7	
9	+5V**	+5V power output

** 250 mA MAX for all outputs combined.

Ethernet Controller Ethernet (10Base-T) Connector

Pin	Signal	Description
1	+TX	10Base-T transmit pair (+) Data terminal
2	-TX	10Base-T transmit pair (-) Data terminal
3	+RX	10Base-T receive pair (+) Data terminal
4	N.C.	Not connected
5	N.C.	Not connected
6	-RX	10Base-T receive pair (-) Data terminal
7	N.C.	Not connected
8	N.C.	Not connected

Ethernet Controller Hand Terminal (COM D) Connector

Pin	Signal	Description
1	RX	RS-232 mode receive data
2	TX	RS-232 mode transmit data
3	-D	RS-485 mode (-) Data terminal
4	+D	RS-485 mode (+) Data terminal
5	GND*	Interface ground
6	+5V**	+5V Power output

* POWER GND and GND are electrically connected. Controller's case is isolated from the controller circuitry and can be grounded externally.

** 250 mA MAX for all outputs combined.

Ethernet Controller Joystick Connector

Pin	Signal	Description
1	N.C.	Not connected
2	GND*	Interface ground
3	+RX	(+) Receive data
4	-RX	(-) Receive data
5	-TX	(-) Transmit data
6	+TX	(+) Transmit data
7	+5V**	+5V Power output
8	GND*	Interface ground

* POWER GND and GND are electrically connected. Controller's case is isolated from the controller circuitry and can be grounded externally.

** 250 mA MAX for all outputs combined.

Ethernet Controller Network Out Connector

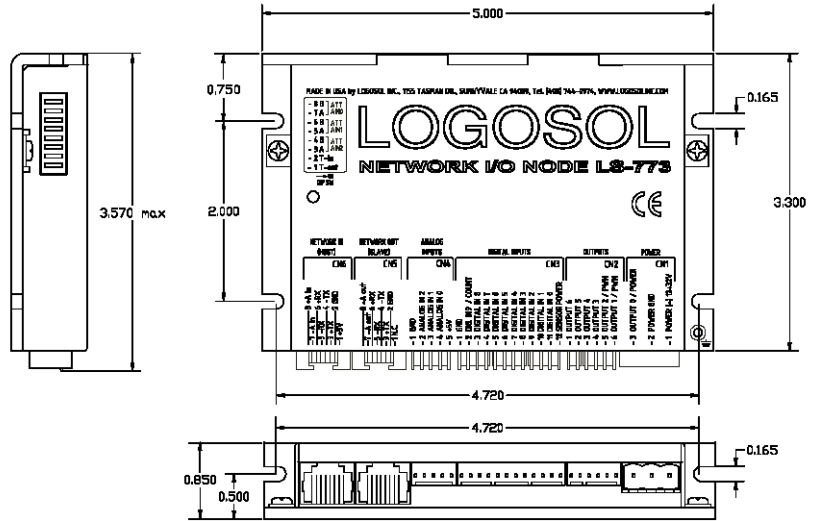
Pin	Signal	Description
1	N.C.	Not connected
2	GND*	Interface ground
3	+RX	(+) Receive data
4	-RX	(-) Receive data
5	-TX	(-) Transmit data
6	+TX	(+) Transmit data
7	+5V**	+5V power output
8	GND*	Interface ground

* POWER GND and GND are electrically connected. Controller's case is isolated from the controller circuitry and can be grounded externally.

** 250 mA MAX for all outputs combined.

Model LS-773 Open Collector I/O Module

Model LS-773 Mechanical Drawing



Model LS-773 Characteristics

Specification	Model LS-373
Power Supply Voltage	12 to 32V DC, 35V absolute maximum
Digital Output 0 (Power)	Solid-state relay—5A
Digital Outputs 1 to 6	Open collector with protective diode to POWER (+) for inductive loads
Max. Voltage (Outputs 1 to 6)	POWER (+) voltage
Maximum Current Load (Outputs 1 to 6)	1A
PWM switching frequency (Outputs 1 and 2)	20KHz

Specification	Model LS-373
Digital Inputs	3K3 pull-up resistors to POWER (+), 50% threshold
Analog Inputs	0-5V, 0-10V, 0-20V or 0-30V DIP switch-selectable modes
Power Connector (CN1)	Magnum EM2565-03-VL or Phoenix contact MSTB 2.5/3-ST-5.08
Output (CN2) Connector	Molex 22-01-3067 housing with 08-50-0114 pins (6 pcs.)
Digital Input (CN3) Connector	Molex 22-01-3127 housing with 08-50-0114 pins (12 pcs.)
Analog Input (CN4) Connector	Molex 22-01-3057 housing with 08-50-0114 pins (5 pcs.)
Network Out (CN5) and Network In (CN6) Connectors	8-pin RJ-45 connector
Red Status LED	LOW—power supply OK HIGH—Output 0/Power=ON
Short Protection	Digital output to Power (+); Output 0/Power to Gnd
Fire Safety—Internal Fuse on POWER (+)	10A, Quick blow
Storage Temperature Range	-30 to +85 °C
Operating Temperature Range	0 to 75 °C
Size	5.00" x 3.30" x 0.85"
Weight	0.55 lb. (.250 kg)

Note: Rated at 25 ° C ambient, POWER(+) = 24VDC

Model LS-773 Dip Switches

SW	Signal	Description	Factory Default
1	T-out	Transmit line terminator	0
2	T-in	Receive line terminator	0
3	A	ANALOG IN2 attenuator	0
4	B		0
5	A	ANALOG IN1 attenuator	0
6	B		0
7	A	ANALOG IN0 attenuator	0
8	B		0

Model LS-773 Pinouts

Model LS-773 Power and Motor (CN1) Connector

Pin	Signal	Description
1	POWER (+)	12 – 32V power supply, positive terminal
2	POWER GND*	Power supply ground
3	OUTPUT 0/POWER	Solid-state relay -5A, w/ short circuit protection

* POWER GND and GND are electrically connected. Driver's case is isolated from driver's circuitry and can be grounded externally.

Model LS-773 Output (CN2) Connector

Pin	Signal	Description
1	OUTPUT 6	Open collector output
2	OUTPUT 5	Open collector output
3	OUTPUT 4	Open collector output
4	OUTPUT 3	Open collector output
5	OUTPUT 2/PWM	Open collector output with PWM mode
6	OUTPUT 1/PWM	Open collector output with PWM mode

Model LS-773 Digital Input (CN3) Connector

Pin	Signal	Description
1	GND *	Signal ground
2	DIG. IN 9/COUNT	Input #9/counter input
3	DIGITAL IN 8	Input #8
4	DIGITAL IN 7	Input #7
5	DIGITAL IN 6	Input #6
6	DIGITAL IN 5	Input #5
7	DIGITAL IN 4	Input #4
8	DIGITAL IN 3	Input #3
9	DIGITAL IN 2	Input #2
10	DIGITAL IN 1	Input #1
11	DIGITAL IN 0	Input #0
12	SENSOR POWER	Wired to POWER (+)

* POWER GND and GND are electrically connected. Driver's case is isolated from driver's circuitry and can be grounded externally.

Model LS-773 Analog Input (CN4) Connector

Pin	Signal	Description
1	GND*	Signal ground
2	ANALOG IN 2	Analog input 0-5V, 0-10V, 0-20V or 0-30V
3	ANALOG IN 1	Analog input 0-5V, 0-10V, 0-20V or 0-30V
4	ANALOG IN 0	Analog input 0-5V, 0-10V, 0-20V or 0-30V
5	+5V	Internal power supply output

* POWER GND and GND are electrically connected. Driver's case is isolated from driver's circuitry and can be grounded externally.

Model LS-773 Network Out (Slave) (CN5) Connector

Pin	Signal	Description
1	N.C.	Not connected
2	GND*	Interface ground
3	+TX	(+) Transmit data
4	-TX	(-) Transmit data
5	-RX	(-) Receive data
6	+RX	(+) Receive data
7	-A out	(-) Address output
8	+A out	(+) Address output

* POWER GND and GND are electrically connected. Driver's case is isolated from driver's circuitry and can be grounded externally.

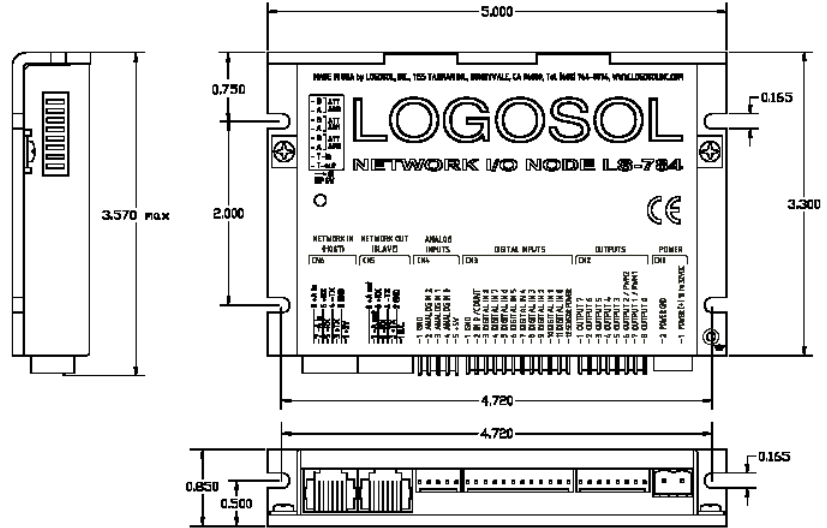
Model LS-773 Network In (Host) (CN6) Connector

Pin	Signal	Description
1	+5V	RS-232 adapter power supply
2	GND*	Interface ground
3	+TX	(+) Transmit data
4	-TX	(-) Transmit data
5	-RX	(-) Receive data
6	+RX	(+) Receive data
7	-A in	(-) Address input
8	+A in	(+) Address input

* POWER GND and GND are electrically connected. Driver's case is isolated from driver's circuitry and can be grounded externally.

Model LS-784 Open Emitter I/O Module

Model LS-784 Mechanical Drawing



Model LS-784 Characteristics

Specification	Model LS-784
Power Supply Voltage	18 to 32V DC, 35V absolute maximum
Digital Output	NPN open emitter with max saturation voltage 2V DC
Maximum Current Load	0.5A
Short/Inductive Load Protection	Output to GND; Clamp diode to GND
PWM Switching Frequency OUTPUT 1(2)/PWM 1(2)	20 KHz
Digital Inputs	Active HIGH with 4.7K to GND Logic HIGH (min) +15VDC to 32VDC Logic LOW (max) -2VDC to +5VDC
Hysteresis (min)	5V min

Specification	Model LS-784
Digital Input Current	6mA max at 24V DC
Max. count frequency (Digital IN 9/COUNT)	20KHz
Sensor Power Voltage and Protection	POWER (+);0.5A resetable fuse
Analog Inputs	8-bit resolution;0-5V,0-10V,0-20V or 0-30V DIP switch-selectable
Power Connector (CN1)	Magnum EM2565-02-VL or Phoenix contact MSTB 2.5/2-ST-5.08
Output (CN2) Connector	Molex 22-01-3087 housing with 08-50-0114 pins (8 pcs.)
Digital Input (CN3) Connector	Molex 22-01-3127 housing with 08-50-0114 pins (12 pcs.)
Analog Input (CN4) Connector	Molex 22-01-3057 housing with 08-50-0114 pins (5 pcs.)
Network Out (CN5) and Network In (CN6) Connectors	8-pin RJ-45 connector
Status LED	LOW—after power up HIGH—after Set Address command
Fire Safety—Internal Fuse on POWER (+)	3A, Quick blow
Storage Temperature Range	-30 to +85°C
Operating Temperature Range	0 to 45°C
Size	5.00" x 3.30" x 0.85"
Weight	0.55 lb. (.250 kg)

Note: Rated at 25° C ambient, POWER(+) = 24VDC

Model LS-784 Dip Switches

SW	Signal	Description	Factory Default
1	T-out	Transmit line terminator	0
2	T-in	Receive line terminator	0
3	A	ANALOG IN2 attenuator	0
4	B		0
5	A	ANALOG IN1 attenuator	0
6	B		0
7	A	ANALOG IN0 attenuator	0
8	B		0

Model LS-784 Pinouts

Model LS-784 Power and Motor (CN1) Connector

Pin	Signal	Description
1	POWER (+) 18 to 32V DC	18 to 32V DC power supply, positive terminal
2	POWER GND*	Power supply ground

* POWER GND and GND are electrically connected. Driver's case is isolated from driver's circuitry and can be grounded externally.

Model LS-784 Output (CN2) Connector

Pin	Signal	Description
1	OUTPUT 7	Open emitter 0.5A max with clamp diode to GND
2	OUTPUT 6	
3	OUTPUT 5	
4	OUTPUT 4	
5	OUTPUT 3	
6	OUTPUT 2/PWM 2	
7	OUTPUT 1/PWM 1	
8	OUTPUT 0	

Model LS-784 Digital Input (CN3) Connector

Pin	Signal	Description
1	GND *	Signal ground
2	IN 9/COUNT	Active HIGH with 4.7KOhm to GND Logic HIGH +15VDC to +32VDC Logic LOW -2VDC to +5VDC Hysteresys 5V min. Max.count frequency 20KHZ (IN9/COUNT)
3	DIGITAL IN 8	
4	DIGITAL IN 7	
5	DIGITAL IN 6	
6	DIGITAL IN 5	
7	DIGITAL IN 4	
8	DIGITAL IN 3	
9	DIGITAL IN 2	
10	DIGITAL IN 1	
11	DIGITAL IN 0	
12	SENSOR POWER	Wired to POWER (+), with 0.5A resetable fuse

* POWER GND and GND are electrically connected. Driver's case is isolated from driver's circuitry and can be grounded externally.

Model LS-784 Analog Input (CN4) Connector

Pin	Signal	Description
1	GND*	Signal ground
2	ANALOG IN 2	Analog inputs 0-5V, 0-10V, 0-20V, 0-30V DIP switch-selectable range
3	ANALOG IN 1	
4	ANALOG IN 0	
5	+5V	Internal power supply output

* POWER GND and GND are electrically connected. Driver's case is isolated from driver's circuitry and can be grounded externally.

Model LS-784 Network Out (Slave) (CN5) Connector

Pin	Signal	Description
1	N.C.	Not connected
2	GND*	Interface ground
3	+TX	(+) Transmit data
4	-TX	(-) Transmit data
5	-RX	(-) Receive data
6	+RX	(+) Receive data
7	-A out	(-) Address output
8	+A out	(+) Address output

* POWER GND and GND are electrically connected. Driver's case is isolated from driver's circuitry and can be grounded externally.

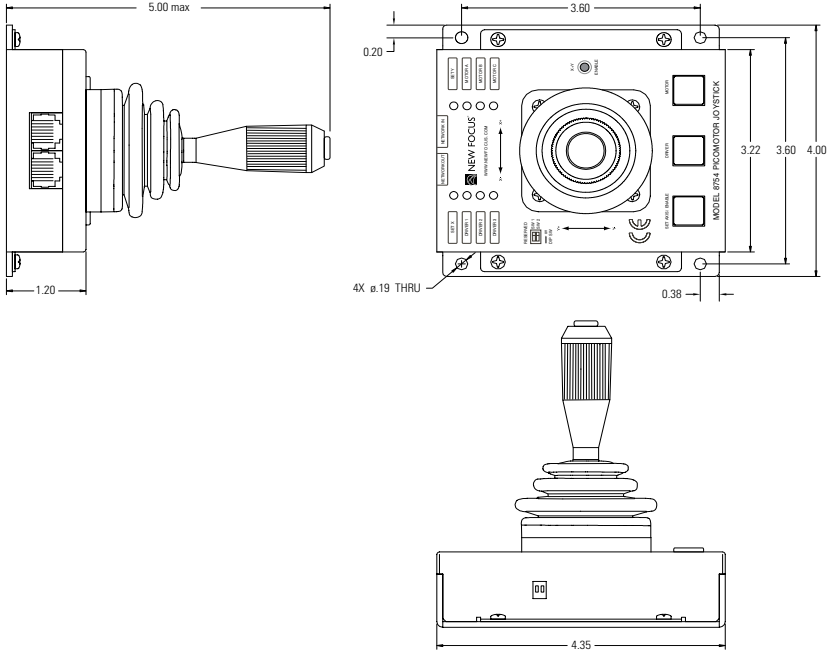
Model LS-784 Network In (Host) (CN6) Connector

Pin	Signal	Description
1	+5V	RS-232 adapter power supply
2	GND*	Interface ground
3	+TX	(+) Transmit data
4	-TX	(-) Transmit data
5	-RX	(-) Receive data
6	+RX	(+) Receive data
7	-A in	(-) Address input
8	+A in	(+) Address input

* POWER GND and GND are electrically connected. Driver's case is isolated from driver's circuitry and can be grounded externally.

Model 8754 Intelligent Picomotor Joystick

Joystick Mechanical Drawings



Note: All dimensions are in inches.

Joystick Characteristics

Specification	Model 8754
Power Supply Voltage	4.75 to 5.25 VDC
Power Consumption	<50 mA
Number of Axes	2
Axes Resolution	8 bits
Power Supply and Communication Interface	8-pin RJ-45
Storage Temperature	-30 to +85° C
Operating Temperature	0 to 45° C
Size (L x H x D)	4.35" x 4.00" x 4.90"
Weight	0.6 lb (0.260 kg)
Certification	CE In conformity with the following standards: EN 60950:2000, 89/336/EEC

Note: Rated at 25° C ambient.

Joystick Pinouts

Joystick DIP Switches

SW	Description
1	Power is supplied from Network Out . (Default is off)
2	Power is supplied from Network In . (Default is on)

Joystick Network Out

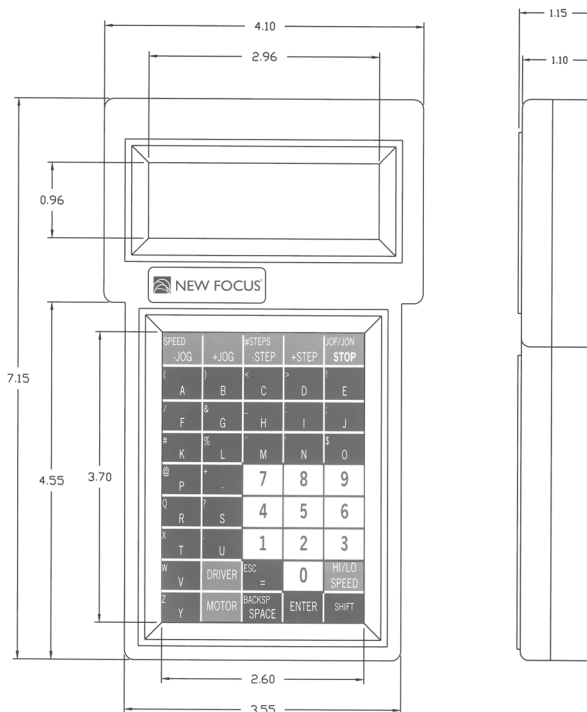
Pin	Signal	Description
1	+5 V slave	SW1 =on: +5 V power supply from slave SW1 =off: Not connected
2	GND	Interface ground
3	+TX	(+) Transmit data
4	-TX	(-) Transmit data
5	-RX	(-) Receive data
6	+RX	(+) Receive data
7	-A out	(-) Address output
8	+A out	(+) Address output

Joystick Network In

Pin	Signal	Description
1	+5V	SW1 =on: +5-V power supply from slave SW1 =off: Not connected
2	GND	Interface ground
3	+TX	(+) Transmit data
4	-TX	(-) Transmit data
5	-RX	(-) Receive data
6	+RX	(+) Receive data
7	+5V host	SW1 =off and SW2 =on: +5 V power supply from host
8	+A in	(+) Address input

Model 8757 Hand Terminal

Hand Terminal Mechanical Drawings

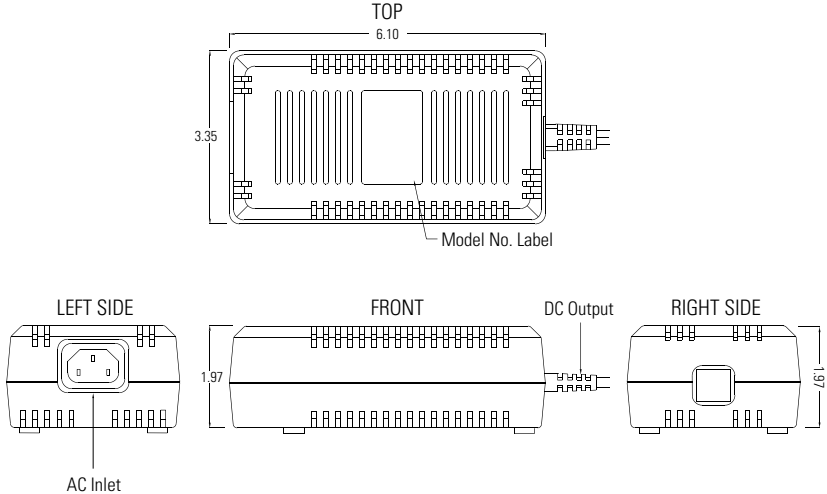


Hand Terminal RS-232

Pin	Signal	Description
1	Tx	Data out from hand terminal
2	Rx	Data in to hand terminal
3	b N.C.	
4	N.C.	
5	Gnd	Interface Ground
6	+5 V DC	Hand terminal power input

Driver Kit Power Supply

Power Supply Mechanical Drawings



Note: All dimensions are in inches.

Power Supply Characteristics

Specification	Model 8755
Input Range	90–264 VAC (wide range)
Frequency	47–63 Hz
Input Current (rms)	2 A @ 90 VAC; 1 A @ 264 VAC Max.
Efficiency	>80% @ full load, 115 VAC (DC conversion)
EMI/RFI	FCC Part 15, Subpart B Class B & CISPR 22
Output Voltage	+24 VDC
Voltage Regulation	±3% @ constant voltage mode
Maximum Power	70 W
Ripple & Noise	1%
Hold-up Time	10 ms typical at full load @ 115 VAC
Protection	Over Voltage Protection (OVP), AC recycle short circuit protection; Output short circuit (<0.03 Ω) Auto recover
Safety	UL 1950; CSA 22.2-234; TUV EN60950; I EC 950; CE EMC & LVD
Operating Temperature	0 to 40° C ambient
Storage Temperature	-10 to 70° C
MTBF	>100,000 hours at full load and 25° C ambient conditions
Cord Length	Shielded AC Input: 6' (±2") Output: 5' (±1")
Certification	CE, UL, CSA

Power Supply Output Connector Pinouts

Pin	Description
1	+24 V
2	RETURN

Models 8301–8341, 8301–8341, and 8351 Picomotors

Picomotor Characteristics

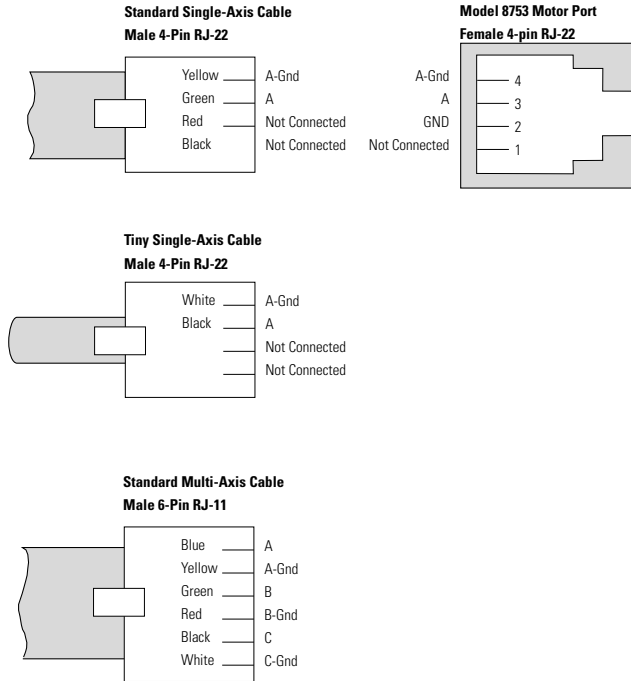
Specifications	Standard MRA	Tiny MRA
Linear Resolution*	<30 nm	<100 nm
Angular Resolution*	<0.6 mrad	<2 mrad
Linear Travel:	Limited by screw length	Limited by screw length
Max. Load:	5 lbs (22 N)	1.5 lbs (6.7 N)
Max. Speed:	0.64 mm/min 2–3 RPM	1 mm/min 2–3 RPM
Temperature Range	10–40° C	10–40° C
Lifetime	2500 standard cycles**	500 standard cycles**

* Since the Picomotor relies on friction to turn the screw, the actual angle change and linear travel per pulse varies a small amount with direction of rotation, load, temperature, and life of the unit. See page 17 for more information on step size.

** One Standard Cycle is defined as 3 mm of travel range out and back pushing a 5 lb axial load.

4-Pin and 6-Pin Picomotor Pinouts

Figure 31: Wiring diagrams for 4- and 6-pin connectors



Vacuum-Compatible Connectors

Vacuum-compatible Picomotors are shipped without connectors attached. For these Picomotors, the red lead is the signal and the white lead is common.

Model 8310 Closed-Loop Picomotor

Picomotor Characteristics

Specification	Model 8310
Mounting	0.375" (9.5 mm) Shank
Linear Travel	0.50" (12.7 mm)
Minimum Incremental Motion	<30 nm
Bi-Directional Repeatability	$\pm 1 \mu\text{m}$ Over Full Travel (approaching target from either direction)
Uni-Directional Repeatability	$\pm 0.1 \mu\text{m}$ Over Full Travel (approaching target from same direction)
Accuracy	$\pm 3 \mu\text{m}$
Limit Sensors	2
Angular Resolution	<0.6 mrad
Maximum Load	5 lbs (22 N)
Torque	2.5 oz-in (0.018 N·m)
Speed (@ 2 kHz pulse rate)	2.4 mm/min (40 $\mu\text{m}/\text{sec}$ typical)
Closed-Loop Settling Time	<100 ms with iPico Controller
Closed-Loop Steady-State Error	0 counts with iPico Controller
Encoder Resolution	63 nm
Survival Temperature Range (non-operating)	-40–150 °C
Operating Temperature	10–40 °C
Lifetime	2500 Standard Cycles*
Connector Type	One Each: 15-Pin D and 4-Pin RJ-22
Cable Length	6 Feet, Both Cables

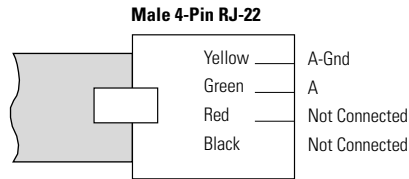
62.5 nm/ encoded count for screw-tip motion; 1250 lines/revolution for encoder. Repeatability and accuracy values were obtained through testing with a 5-lb pre-load on the picomotor with Krytox GPL205 grease used to reduce friction and wear in the interface between the ball end of the picomotor and the test equipment. Ideally, the ball end of the picomotor should impinge upon a polished, flat, hard surface (preferably sapphire) for best results.

* One standard cycle is defined as 3 mm of travel range out and back pushing a 5-lb axial load.

Closed-Loop Picomotor Pinouts

Motor

Figure 32: Wiring diagram for motor connector



Encoder

Pin	Signal	Description
1	+5**	+5 V Limit sensors power supply
2	+L	Forward limit input
3	-L	Reverse limit input
4	-A	Encoder phase _A
5	+A	Encoder phase +A
6	\perp *	Interface ground
7	AN	Analog input
8	AG	Analog input ground
9	-B	Encoder phase -B
10	+B	Encoder phase +B
11	AP	Analog +5 V
12	+5**	+5 V Encoder power supply
13	\perp *	Interface ground
14	+Z	Encoder index
15	TY	Piezo Motor type (Open = Standard, GND = Tiny)

* POWER GND and GND are electrically connected.

** 0.25A Max for all outputs combined

Customer Service

Technical Support

Information and advice about the operation of any New Focus product is available from our technical support engineers.

Engineers are on duty from 8:00–5:00 PST, Monday through Friday (excluding holidays). For quickest response, ask for “Technical Support” and know the model number of your photoreceiver.

Phone: (408) 919-1500

Fax: (408) 980-8883

Support is also available by email: techsupport@newfocus.com

We typically respond to email within one business day.

Service

In the event that your product malfunctions or becomes damaged, please contact New Focus for a return authorization number and instructions on shipping the unit back for evaluation and repair.

